



PACKAGING AND TECHNICAL DATA

omerin
LES CABLES DE L'EXTREME



- The world's leading manufacturer of silicone-insulated wires and cables
- Europe's leading manufacturer of glass-yarn braids
- France's leading manufacturer of fire safety cables

The Omerin group has been producing electrical cables for extreme conditions since 1959

At Omerin, we use our know-how and technology to develop increasingly high-performance products.

Our expertise is recognized in over 120 countries.

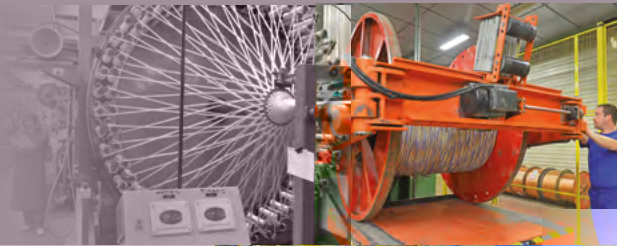

Omerin offers a wide range of high-performance products covering a large number of applications in very diverse industries, including the electrothermal construction, electromechanical, chemical, nuclear energy, railway, naval, aeronautical, heavy industry, power plant and other sectors.

Our product range is further extended by varnished, impregnated and treated braided insulating sleeveings, door seals for ovens, fireproof sleeveings, thermocouple, extension and compensation cables as well as industrial braids.

Men and women at your service

The technical expertise of our teams is at your disposal, providing responses and solutions to all your requirements.

Our Methods, Quality and Research and Development Departments work permanently together with the aim of constantly improving our products and processes.

All our staff subscribe to this approach with their involvement and constant self-checking at all stages of production.

List of all the available catalogues:

HIGH TEMPERATURE WIRES AND CABLES FOR THE GENERAL MARKET SECTION I: CROSS LINKED ELASTOMERS 1

HIGH TEMPERATURE WIRES AND CABLES FOR THE GENERAL MARKET SECTION II: FLUOROPOLYMERS AND THERMOPLASTICS 2

HIGH TEMPERATURE WIRES AND CABLES FOR THE GENERAL MARKET SECTION III: COMPOSITE INSULATIONS 3

FIRE RESISTANT SAFETY CABLES 4

CABLE SOLUTIONS FOR ROLLING STOCK 5

CABLES FOR POWER STATIONS AND HIGH-RISK SITES 6

MARINE CABLES 7

PYROMETRY CABLES 8

BRAIDED INSULATING SLEEVINGS 9

HIGH TEMPERATURE MEDIUM VOLTAGE POWER CABLES 10

PACKAGING AND TECHNICAL DATA

Ultimately, this catalogue is the result of the passionate endeavours of an entire team, who have displayed great talent in writing it for you.

It is designed to be a simple and concise working tool for you, serving as a reference document that is able to meet the majority of your needs.

This catalogue, as well as ten others from our collection are available on line with real time updates and much more information at

www.omerin.com

All the trademarks listed below are registered trademarks of the OMERIN Group.

BIO-HABITAT®	Wires and cables for a home without electromagnetic interference
CERAFIL®	Miniature ceramic insulated wires for very high temperatures
COAXRAIL®	Coaxial cables for railway industry
COAXTHERM®	High temperature coaxial cables
COUPLIX®	Pyrometry cables (thermocouples, extension, compensation cables)
DATARAIL®	Data cables for the railway industry
ELECTROAIR®	Aerospace & Defence wires and cables
ENERSYL®	Electrical cables for power station and high risk sites
FLEXBAT®	Extra flexible battery cables
LUMIPLAST®	Wires and cables for lighting systems
METALTRESSE®	High performance metallic braids
MINOROC®	Very high tensile strength synthetic cables
MULTIMAX®	Power, control and instrumentation cables for the marine industry
MULTI-VX®	Hybrid data and power cables
ODIOSIS®	Sound, amplification and loudspeaker cables
OILPLAST®	Cables for industrial environments and intrinsically safe system
OMBILIFLEX®	High performance special multi-function cables
PLASTHERM®	Special thermoplastic insulated wires and cables
POWER CONNECT®	High performance power cords
PROFIPLAST®	Thermoplastic insulated wires and cables
PYRISOL®	Fire resistant power cables for safety circuits
PYRITEL®	Fire resistant communication cables for safety circuits
SILIBOX®	Wire and cables cardboard box packaging system
SILICABLE®	Special high temperature wires and cables
SILICOUL®	Low and medium voltage class H (180°C) power cables
SILIFLAM®	Very high safety cables for extreme temperatures
SILIFLON®	Fluoropolymer insulated high temperature wires and cables
SILIGAINE®	Braided insulating sleeveings
SILIRAD®	Electron beam cross-linked cables
SILITUBE®	Braided or extruded tubes
SOLARPLAST®	Power cables for photovoltaic solar panels
SONDIX®	Platinum resistance temperature sensors connection cables
SPIRFLEX®	High performance spiral cables
TEXALARM®	Cables for safety systems and fire alarms
TS CABLES®	Coaxial and data cables
TS COM 900®	Telephonic cables for very speed reception
TS LAN®	Copper LAN cables
TWINLINK®	High temperature controlled impedance twisted pair cables
TWINPLAST®	Extra flexible cables for battery chargers or jump starters
VARPREN®	Wires and cables with special cross-linked Varpren® insulation
VEROX®	Fiberglass braided seals
VIDEOCOAX®	Analogue and digital video cables



Thermal classification of insulations

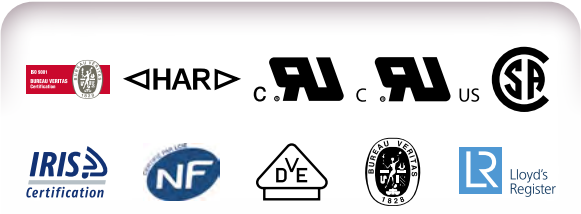
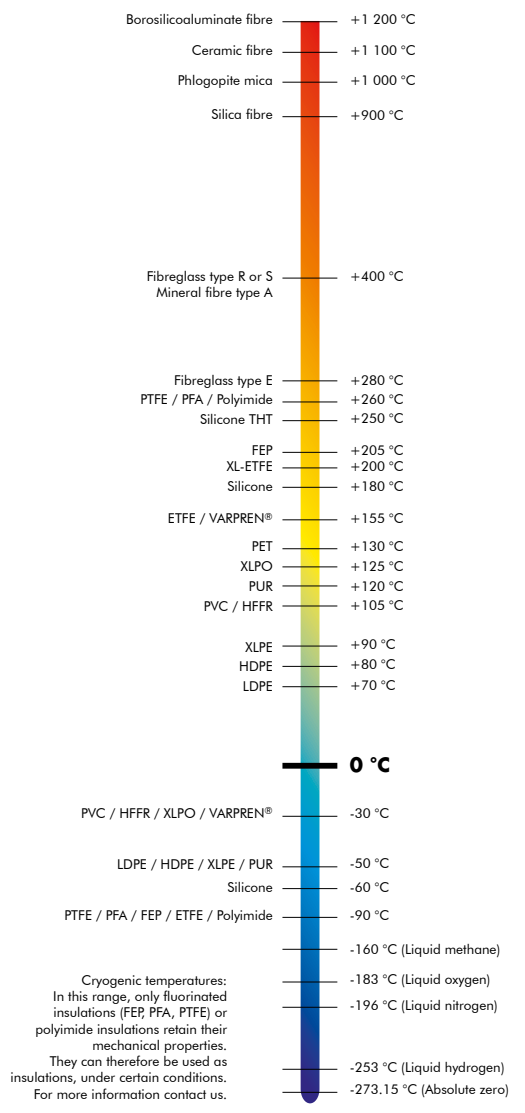

Contents

PACKAGING OPTIONS	Pages 4 to 7
GENERAL	Pages 8 to 9
CONDUCTING CORES	Pages 10 to 13
INSULATIONS	Pages 14 to 15
PERMISSIBLE CURRENTS	Pages 16 to 17
FIRE AND FLAME TESTS	Pages 18 to 20
STANDARDS AND NORMS	Page 21
INTERNATIONAL SYSTEM OF UNITS	Page 22
CONVERSION FACTORS	Page 23

Packaging on spools

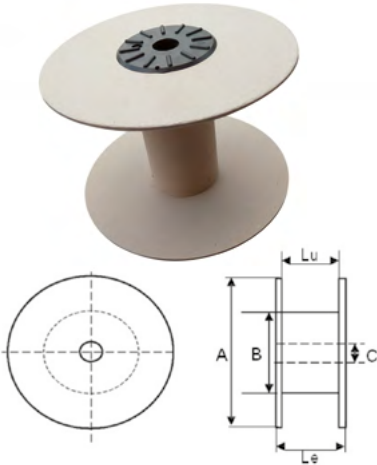

Spool dimensions

Spool reference			Nature of flanges	Diameter A mm	Diameter B mm	Diameter C mm	Le mm	Lu mm	Approximate weight g
ODP	ODS	ODB							
Cat. T - Spools									
-	-	B 120A	Plastic	120	50	45	40	35	48
-	-	B 120B	Plastic	120	50	45	105	100	58
-	-	B 170A	Plastic	170	67	64	72	68	92
-	-	B 170B	Plastic	170	70	61.1	128	120	152
-	-	B 225	Plastic	225	72	67.5	60	54	192
-	-	B 270	Plastic	270	100	30	140	125	480
B 300	B 300 cardboard	-	Cardboard	300	100	30	210	200	730
B 300-BLA	B 300 plastic	-	Plastic	300	100	30	220	200	720
Cat. D - DIN spools									
D 80	-	-	Plastic	80	50	15	80	65	80
D 100	-	-	Plastic	100	60	15	100	80	125
D 125	-	-	Plastic	125	80	15	125	100	160
D 160	-	-	Plastic	160	100	22	160	123	360
D 200	-	-	Plastic	200	125	22	200	160	630
D 250	-	-	Plastic	250	160	22	197	160	1 050

Theoretical spool capacity according to product diameter

Ref. ODP	D 80	D100	D 125	D 160	D 200	D 250	-	-	-	-	-	-	B 300 or B 300-BLA
Ref. ODS	-	-	-	-	-	-	-	-	-	-	-	-	B 300 Cardboard or B 300 Plastic
Ref. ODB	-	-	-	-	-	-	B 120A	B 120B	B 170A	B 170B	B 225	B 270	-
Diameter of product (mm)	Maximum cable length on SPOOL* (linear m)												
0.3	1 210	2 820	4 470	9 170	20 890	-	2 620	7 530	11 240	19 510	17 370	-	-
0.4	690	1 570	2 480	5 210	11 710	-	1 480	4 240	6 320	10 910	9 730	-	-
0.5	440	1 020	1 610	3 340	7 590	12 350	950	2 710	4 060	7 020	6 270	-	-
0.6	290	710	1 110	2 290	5 140	8 500	660	1 880	2 780	4 880	4 340	12 860	24 510
0.7	220	510	800	1 660	3 830	6 290	470	1 340	2 050	3 550	3 180	9 420	18 010
0.8	160	380	600	1 300	2 930	4 730	360	1 040	1 580	2 730	2 410	7 150	13 850
0.9	130	300	470	1 010	2 280	3 690	280	830	1 220	2 160	1 920	5 660	10 890
1.0	110	250	400	830	1 860	3 090	240	680	1 000	1 760	1 550	4 640	8 890
1.1	90	200	310	680	1 560	2 470	190	550	820	1 410	1 290	3 800	7 280
1.2	70	170	270	550	1 250	2 120	160	470	680	1 200	1 070	3 180	6 050
1.3	60	140	220	480	1 110	1 750	140	390	580	1 010	910	2 690	5 190
1.4	50	120	190	410	930	1 570	120	330	510	880	790	2 320	4 430
1.5	40	110	180	360	820	1 340	100	300	450	780	680	2 050	3 870
1.6	40	90	150	310	730	1 150	80	250	390	680	580	1 760	3 460
1.7	30	80	120	270	650	1 030	80	220	340	590	530	1 590	3 060
1.8	30	70	120	250	570	920	70	200	290	540	470	1 390	2 720
1.9	30	60	100	220	500	830	60	170	270	470	420	1 250	2 400
2.0	30	60	90	210	440	750	60	170	250	430	380	1 130	2 190
2.1	-	60	90	180	430	670	50	150	230	390	340	1 010	1 980
2.2	-	40	70	170	370	590	40	130	200	350	310	940	1 780
2.3	-	40	70	140	320	570	40	130	190	320	290	850	1 600
2.4	-	40	70	140	310	510	40	110	170	290	260	790	1 510
2.5	-	40	60	130	300	490	40	110	150	280	240	740	1 420
2.6	-	30	50	110	260	430	30	90	140	250	220	660	1 260
2.7	-	30	50	110	250	390	30	90	140	230	210	610	1 190
2.8	-	30	50	100	220	370	30	80	120	220	190	560	1 110
2.9	-	30	50	80	210	360	30	80	120	200	170	520	1 030
3.0	-	30	40	80	210	320	20	70	100	200	170	510	960
3.2	-	-	30	80	170	270	20	60	90	170	140	440	830
3.4	-	-	30	60	160	260	20	50	80	150	130	390	760
3.6	-	-	30	60	130	220	20	50	70	130	110	330	650
3.8	-	-	-	50	130	210	10	40	60	110	100	300	590
4.0	-	-	-	50	100	170	10	40	60	110	90	270	550
4.2	-	-	-	40	100	170	10	40	60	90	80	240	490
4.4	-	-	-	40	90	140	10	30	50	90	80	240	440
4.6	-	-	-	30	70	130	10	30	40	70	70	210	400
4.8	-	-	-	30	70	130	10	30	40	70	60	190	360
5.0	-	-	-	30	70	120	10	30	40	70	60	190	360
5.5	-	-	-	-	60	90	10	20	30	50	50	140	280
6.0	-	-	-	-	40	70	10	20	20	40	40	120	240
6.5	-	-	-	-	40	70	-	10	20	30	40	100	200
7.0	-	-	-	-	30	60	-	10	20	30	30	80	170
7.5	-	-	-	-	30	50	-	10	20	30	20	80	150
8.0	-	-	-	-	30	40	-	10	10	20	20	70	130
8.5	-	-	-	-	-	40	-	10	10	20	20	50	120
9.0	-	-	-	-	-	30	-	10	10	20	20	50	100
9.5	-	-	-	-	-	30	-	10	10	10	10	40	80
10.0	-	-	-	-	-	30	-	10	10	10	10	40	80

* Indicative quantity varying according to the flexibility of the core and type of insulation.

Note: All our products supplied on spools are externally protected with a cardboard or plastic film band.

www.omerin.com

The information provided in this technical data sheet is indicative and may be modified without prior notice, laying, wiring and electrical conditions and the environment of the cable can not be fully considered in our studies. In no way the company OMERIN shall be held responsible for any incidents in the case of inappropriate uses, particularly in the case of wiring conditions that do not respect the good practice and the standards in force.

For an optimum use of the cables produced by our company, we recommend testing in real conditions. Our sales department is available for a possible provision of samples, and/or for the conditions of a complete study in our laboratories.

® Registered trademark of the OMERIN Group. Drawings and photos are not contractual. Reproduction is prohibited without the prior agreement of OMERIN.

Packaging in SILIBOX®

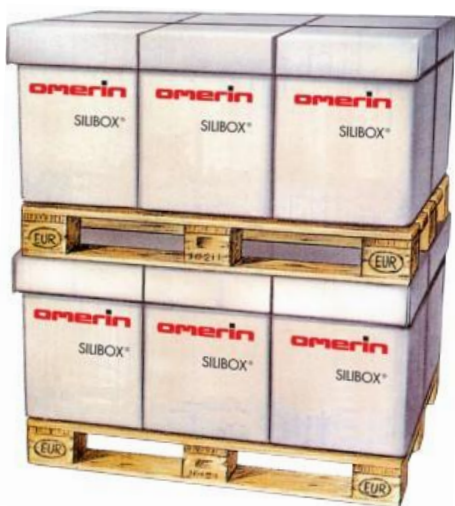

Benefits of SILIBOX® packaging

- Recyclable disposable packaging on Euro Pallets (1200 x 800 mm) developed by OMERIN SAS.
- No deposits or returns.
- Reduced packaging waste.
- Easier handling.
- Reusable or recyclable boxes, practical and ecological.
- Reduced dimensions and storage costs.
- No costly or complicated unwinding system required: a simple return system positioned approx. 1.50 m above the box enables the cable to be pulled at high speed without breaking, entanglement and twisting.

Independent boxes, individual lids and labels,
individual handling grips.



Box dimensions:
400 mm x 400 mm. Height 500 mm

Theoretical capacity of SILIBOX® according to cable diameter

Product diameter mm	Maximum length of product on SILIBOX® m
1.0 to 1.2	8 000 to 6 500
1.2 to 1.5	6 500 to 5 500
1.5 to 1.7	5 500 to 5 000
1.7 to 1.9	5 000 to 4 400
1.9 to 2.1	4 400 to 3 600
2.1 to 2.3	3 600 to 3 200
2.3 to 2.6	3 200 to 2 500
2.6 to 3.0	2 500 to 2 000
3.0 to 4.0	2 000 to 1 000
> 4.0	< 1000

Note: These quantities are likely to vary in significant proportions according to the rigidity of the cable, the nature of the insulation, etc.

The following references do not allow silibox packaging:

- Wire with cross section bigger than 2.5 mm².
- Wire with diameter above 5 mm or below 1 mm.
- Reference with silicone varnished braid (ex CSV, VS, NVS).
- Reference with thick silicone insulation (type CSVRI-HT, style 3304).
- Reference with PTFE tape insulation (ex KZ, EE...).
- Wire with solid core (class 1) and extra-flexible core (class 6).

Other packaging options

Rolls



Certain products (e.g. electric wires, sleeves, etc.) can be delivered in rolls (see illustration).

A roll features winding of product (wire or sleeve), with or without cardboard support. The product is maintained by adhesive tapes or stretchable film.

Some sleeves can be supplied in kit spool form. The flanges are made of cardboard and metal. Several spool dimensions are available (see illustration and table below).

Spool kit



Some sleeves can be supplied in kit spool form. The flanges are made of cardboard and metal. Several spool dimensions are available (see illustration and table below).

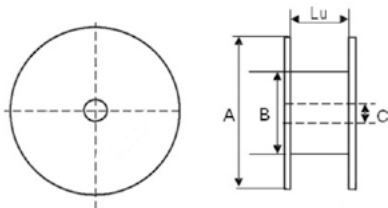

Ref. ODP	Ø A (mm)	Ø B (mm)	Ø C (mm)	Lu (mm)
B180/100	180	82	30	100
B180/150	180	82	30	150
B300/100	300	82	30	100
B300/150	300	82	30	150
B300/200	300	82	30	200

Instruction for transport, handling and storage

General rules

For storage, transport and when handling, loading and unloading, care must be taken for not damaging the product or its packing, and so as not to alter its future use.

Upon reception, a visual control of the product and its packaging must be carried out, in order to make sure that everything is OK.

Storage guidelines

For a good preservation of our products, they have to be stored as a general standard:

- In their original packing
- Protected from rain, in a dry place, with no risk of excessive humidity
- Protected from direct sun rays
- At temperatures from -10°C up to + 40°C
- Sheltered from shocks and other risks (clean and flat floor, sufficient spacing between the reels, ...)
- Do not stack the reels, store them vertically (horizontal axis)
- It is recommended to store the spools of wire vertically (horizontal axis).

Specific instructions for reels and drums with flanges of diameter of 750 mm and more

Reels must be transported vertically, hold in place so as not to collide into each other. The impact could damage the outer sheathing of the cables. Transport of such size reels with flanges in a horizontal position is prohibited.

Unloading and handling will be done with lifting machines. If a forklift truck is used, the lifting will be done with a beam going through the central axis of the reel, or with the forks. In the later case, place both forks on both sides of the reel, and make sure that both flanges of the reel are onto the forks. At no time the forks must touch the cable.

In the case of a lifting machine, the lifting will be done with a beam and a sling which length will be long enough so the strength applied on the flanges of the reel will not be too important. The strength can be limited by the use of a lifting beam. At no time the lifting machine must touch the cable.

All these conditions are indicatives and non exhaustives.

Comments on selecting an OMERIN cable

For reliable long-term service, it is important to select the right electric cable or wire for the application. The current cable market features many products whose main qualities are as much a result of the properties of insulation products available at this time, as the construction and the protection systems applied to cables. Relying on past experience may often be useful, but can sometimes be just as dangerous. As cable dimensions restrictions are sometimes complex, it is difficult to generally and directly assign a genuine advantage to various types of cables without deeper analysis of the intended application.

It is therefore essential to know all the environmental conditions for the application to ensure the cable is correctly dimensioned. Although non-exhaustive, the list below indicates the main restrictions to be taken into account in specifying electrical cables:

- **Electrical resistance:** All the electrical requirements of the application (type and voltage of power supply, current strength, etc.) are required and mandatory to define the cable. In particular, remember that the intrinsic temperature of the conductor may have a significant influence on its linear resistance. Furthermore, concerning the cable insulation, its insulation resistance varies according to its temperature.
- **Thermal resistance:** Exposure to excessive temperatures over a too long period may cause premature deterioration of the constituent cable materials (fissuring, combustion, flaking, etc.). The period of exposure is therefore as important as the temperature value itself, in the choice of materials which must resist both brief, high thermal shocks and prolonged exposure at lower temperatures. In this matter, note that the overall thermal resistance of the cable may not be higher than that of the constituent part with the lowest thermal resistance.
- **Presence of humidity:** For certain materials, the absorption of humidity may vary to certain degrees. If it exceeds a certain threshold, the level of humidity may generate faults within the electrical system itself.
- **Fire and/or flame resistance:** The non-spreading of vertical or horizontal flames may be a major characteristic of a cable. However, fire resistance is a completely different property to flame resistance. Indeed, for certain types of cable, applicable regulations impose a minimum duration of fire resistance, while maintaining the operational integrity of the cable.
- **Resistance to mechanical forces:** Certain forces of mechanical origin and external to the cable (bending, impacts, abrasion, crushing, etc.) may cause premature deterioration of certain insulation and sheathing materials (mechanical fatigue) and may cause the long-term loss of certain properties that are essential to the cable's life. For example and in general, tape insulation systems have difficulty supporting alternate bending cycles.
- **Resistance to chemical products:** Certain categories of chemical products (hydrocarbons, solvents, acids, etc.) may damage insulation or sheathing materials used on cables. Fluorinated materials are in general more resistant to chemical attacks than other materials used for cable insulation or sheathing.
- **Resistance to cryogenic temperatures:** In general, most materials used at low temperatures become brittle (flaking) or lose their natural flexibility. Only fluorinated insulation materials or polyimides retain their mechanical properties at cryogenic temperatures.
- **Pouring of molten metals:** This is often accidental and may cause partial or total destruction of the cable. Certain smart combinations of insulation or sheathing materials can nonetheless considerably reduce the risks of damage to the cable due to molten metal.
- **Emission and toxicity of smokes:** In case of fire, certain safety regulations define limits on the quantity of smokes emitted, along with their nature and toxicity rating. Certain materials present interesting properties in this area (fibreglass, silicone rubber, halogen-free polymers, etc.).
- **Resistance to radiation:** Taking into account this factor may be restrictive to the cable dimensioning. Indeed, certain materials such as polyimide insulation resist more effectively to radiation than other materials.

The following pages provide information on the materials used to make OMERIN cables. Our technical departments are at your service to provide all further information required.

Glossary

Conducting core (or conductor)

• The conductor core of a cable carries the current. It is generally circular, sometimes compacted. It comprises one or more strands of the same conducting metal, which in most cases can be aluminium or copper. To improve certain properties of the conducting metal, copper strands may be coated with a metal layer. Sometimes, which resistance to high temperatures is required, a conductor core made entirely of pure nickel strands is necessary.

- **Stranded core (IEC 60228 class 2):** circular core (compacted or not) comprising a set of wires assembled together.
- **Flexible core (IEC 60228 class 5):** circular core comprising a set of wires assembled together in concentric or bunched strands.
- **Ultra-flexible core (IEC 60228 class 6):** circular core comprising a set of very fine wires assembled together in concentric or bunched strands.
- **Concentric strand:** geometrically-arranged spiral assembly of wires featuring one or more separate layers.
- **Bunched strand:** spiral assembly where the wires have no pre-defined position.
- **Composite strand:** geometrical assembly of several concentric or bunched strands featuring one or more separate layers.
- **Theoretical cross-section:** Where n is the number of strands making up the core and d is the diameter of the strands, the theoretical cross-section is given by the following formula:

$$S = n \cdot \pi d^2 / 4$$

- **Nominal cross-section:** conventional or standard value of a core cross-section.

Insulation

Single or multi-part layer, whose function is to electrically insulate the core against the outside.

- **Extruded insulation:** composite based on elastomer or thermoplastic technology forming a continuous, uniform and homogeneous layer.
- **Composite insulation:** composite featuring synthetic or mineral wires or tapes, lapped, braided, woven or wound around the core and treated, coated, lacquered or left in a natural state.

Insulated conductor

Comprises the core, its insulation and possible other components (screen, separator, etc.).

Assembly or twisted conductors

Lexicon of vocabulary commonly used by the cable industry and/or defined in installation standards

MECHANICAL STRESS IMPACT according to NF C 15-100

- **AG1** Low severity (Normal, e.g. household and similar equipment)
- **AG2** Medium severity (Standard industrial equipment, where applicable, or reinforced protection)
- **AG3** High severity (Reinforced protection)
- **AG4** Very high severity (mines, quarries...)

RESISTANCE TO SOLAR RADIATIONS AND WEATHER

- **Excellent** Permanent exposure
- **Very good** Frequent exposure
- **Good** Occasional exposure
- **Fair** Accidental exposure
- **Poor** No exposure

PRESENCE OF WATER according to NF C 15-100

- **AD1** Negligible (probability of presence of water is negligible)
- **AD2** Free falling drops (probability of presence of water is negligible)
- **AD3** Sprays (possibility of water falling as a spray at an angle up to 60° from the vertical)
- **AD4** Splashes (possibility of splashes from any direction)
- **AD5** Jets (possibility of jets of water from any direction)
- **AD6** Waves (possibility of water waves, seashore locations)

Group of insulated conductors assembled together, most commonly with a spiral layout, in one or more layers. The assembly pitch defines the length of a full rotation of the spiral along the axis of the cable, by a constituent component.

Filler

Material whose function is to fill the gaps between the constituent components of an assembly.

Separator

Film inserted between two components of a conductor or a cable to prevent interactions between them or to facilitate their separation. May also be used to facilitate the cable manufacturing.

Screen

Conductive layer comprising metal tapes, generally made of aluminium or copper, metallic braids, generally copper, whose function is to insulate the conductor or the cable against external electromagnetic fields that may disturb its operation.

Inner sheath

Continuous tubular layer of a non-metal material (elastomer or thermoplastic), usually extruded and covering the screen or the assembly of conductors and filler if any.

Bedding

Layer of under-armour material.

Armour

Layer of metal foil, round or flat metal wires, intended to protect the cable from external mechanical effects. The armour may be on the outside of the cable.

Outer sheath (jacket)

Continuous, uniform tubular layer of a non-metal material (elastomer or thermoplastic), usually extruded and applied to the external part of the cable to provide external protection. The outer sheath must be appropriate for the immediate surroundings of the cable (humidity, water, fire, oils, solvents & chemical products, aggressive weather, UV radiation, X-rays, etc.).

- **AD7** Immersion (possibility of intermittent partial or total covering by water)
- **AD8** Submersion (equipment is permanently and totally covered)

CHEMICAL RESISTANCE

- **Excellent** Permanent contact
- **Very good** Frequent contact
- **Good** Occasional contact
- **Fair** Accidental contact
- **Poor** No contact

BEHAVIOUR TO FIRE according to NF C 32-070

- **C1** Fire retardant
- **C2** Flame retardant
- **C3** No classification to fire resistance
- **CR1** Fire resistant
- **CR2** All cables which are not CR1

www.omerin.com

omerin
LES CABLES DE L'EXTREME

The information provided in this technical data sheet is indicative and may be modified without prior notice, laying, wiring and electrical conditions and the environment of the cable can not be fully considered in our studies. In no way the company OMERIN shall be held responsible for any incidents in the case of inappropriate uses, particularly in the case of wiring conditions that do not respect the good practice and the standards in force. For an optimum use of the cables produced by our company, we recommend testing in real conditions. Our sales department is available for a possible provision of samples, and/or for the conditions of a complete study in our laboratories.
© Registered trademark of the OMERIN Group. Drawings and photos are not contractual. Reproduction is prohibited without the prior agreement of OMERIN.

Nominal stranding and flexibility class

Nominal cross-section		Solid cores 1 x d	Compacted round cores Number of strands	d n x d	Other stranding options - Number of strands / Diameter of strand (mm)											
(mm ²)	AWG				0.50 n x 0.50	0.40 n x 0.40	0.30 n x 0.30	0.25 n x 0.25	0.20 n x 0.20	0.16 n x 0.16	0.15 n x 0.15	0.13 n x 0.13	0.10 n x 0.10	0.07 n x 0.07	0.05 n x 0.05	
0.03	-	1 x 0.20										10	20			
0.05	30	1 x 0.25								3	4	7	30			
0.07	-	1 x 0.30								4		10	20	40		
0.09	28							3			7	12	50			
0.12	-	1 x 0.40						4		7	9	15	30	60		
0.13	26							3		7	10	17				
0.14	-	1 x 0.43								8	11	18		70		
0.15	-							5			12	19	40	80		
0.2	-	1 x 0.50						4		10	12	15	26	50	100	
0.22	24	1 x 0.52				3			7	11	13	17	28		110	
0.25	-		7 x 0.22					5		8		14	19	30	60	130
0.34	22	1 x 0.67				3	5	7	11	17	19	26	40	90	180	
0.38	-							8	12	19	22	30	50	100	200	
0.5	-	1 x 0.80	19 x 0.18		4	7	10	16	25	28	38	60	130	260		
0.6	20		4 x 0.43	3	5	9	12	19	30	34	46	80	160	310		
0.75	-	1 x 0.98	7 x 0.37													
0.75	-		19 x 0.22	4	6	11	15	24	37	42	56	100	200	390		
0.88	18					7	12	18	26	44	50	70	110	230	450	
0.93	-			5				19	30	47	54	72	240	470		
1	-	1 x 1.13	7 x 0.43													
1	-		19 x 0.26			8	14	21	32	50	57	77	120	260	520	
1.34	16		7 x 0.49	7	11	19	27	41	70	77	108	170	350	680		
1.5	-	1 x 1.38	7 x 0.52													
1.5	-		19 x 0.32	8	12	21	30	48	77	84	120	190	390	750		
2	14	1 x 1.60	7 x 0.64													
2	14		19 x 0.37	11	17	27	43	65	108	112	168	290	550	1 080		
2.5	-	1 x 1.77	7 x 0.67	13	19	35	50	80	126	140	192	320	650	1 280		
3	-			16	24	45	61	98	156	180	247	420	780	1 530		
-	12		37 x 0.34	17	26	46	66	103	168	192	266	450	840	1 650		
4	-	1 x 2.24	7 x 0.85	21	32	56	80	126	204	224	323	550	1 050	2 060		
5	-			26	40	70	105	168	264	300	399	680	1 330	2 610		
-	10		37 x 0.43	27	42	77	107	171	266	304	418	700	1 370	2 690		
6	-	1 x 2.74	7 x 1.04	31	48	84	120	192	304	343	475	800	1 540	3 020		
-	8			43	66	119	171	266	418	481	666	1 130	2 200	4 320		
10	-		7 x 1.33	50	77	140	209	322	518	592	814	1 380	2 700	5 300		
-	6			68	105	190	276	444	703	814	1 110	1 880	3 690			
16	-		7 x 1.68													
16	-		19 x 1.04	77	119	224	323	516	814	925	1 258	2 130	4 180			
-	4			108	168	316	444	703	1 110	1 295	1 739	2 940	5 770			
25	-		7 strands	123	192	354	518	798	1 295	1 480	2 013	3 400				
35	2		7 strands	166	259	495	703	1 121	1 739	2 013	2 684	4 540				
-	1			219	342	608	888	1 406	2 196	2 501	3 355	5 670				
50	-		19 strands	237	370	740	1 036	1 628	2 562	2 928	3 904					
-	1/0			272	425	777	1 147	1 813	2 867	3 294	4 392					
70	2/0		19 strands	333	543	1 036	1 406	2 257	3 477	3 965	5 307					
-	3/0			432	684	1 221	1 776	2 775	4 392	5 002						
95	-		19 strands	444	740	1 369	1 813	2 979	4 453	5 124						
-	4/0			546	851	1 517	2 196	3 441	5 429							
120	-		19 strands	568	925	1 776	2 318	4 144								
-	250 MCM			645	1 036	1 850	2 684	4 209								
150	300 MCM		19 strands	703	1 184	2 220	2 867	4 880								
185	350 MCM		37 strands	888	1 443	2 738	3 660	5 856								
-	400 MCM			1 036	1 628	2 928	4 270									
240	-		37 strands	1 184	1 924	3 552	4 758									
-	500 MCM			1 295	2 035	3 626	5 246									
300	600 MCM		61 strands	1 480	2 368	4 209										
-	700 MCM			1 830	2 849	5 063										
400	750 MCM		61 strands	1 952	3 050	5 429										

As per standard IEC 60228 (or NF C 32-018): Class 1 (or A) Class 2 (or B) Class 5 (or C) Class 6 (or D)

Note: The nominal stranding compositions indicated in the table above (and in all pages of all OMERIN catalogues) are indicative. The number and/or diameter of the strand(s) may vary within the limits defined by the applicable standard(s). Only the maximum linear resistance at 20°C is the guaranty of compliance with the standard.

Stranding compositions in bold are preferential; the others are given for informational purposes and are not available on standard products.

www.omerin.com



The information provided in this technical data sheet is indicative and may be modified without prior notice, laying, wiring and electrical conditions and the environment of the cable can not be fully considered in our studies. In no way the company OMERIN shall be held responsible for any incidents in the case of inappropriate uses, particularly in the case of wiring conditions that do not respect the good practice and the standards in force. For an optimum use of the cables produced by our company, we recommend testing in real conditions. Our sales department is available for a possible provision of samples, and/or for the conditions of a complete study in our laboratories.

© Registered trademark of the OMERIN Group. Drawings and photos are not contractual. Reproduction is prohibited without the prior agreement of OMERIN.

**Main properties
of metals commonly used
by OMERIN SAS:**

Type of metal	OMERIN name	Continuous operating temperature °C	Peak temperature °C	Melt temperature °C	Density at 20 °C g.cm ⁻³	Volume electrical resistivity at 20 °C. μΩ.cm	Resistance variation coefficient (α) at 20 °C 10 ⁻³ .K ⁻¹	Thermal conductivity at 20 °C W.m ⁻¹ .K ⁻¹	Specific heat capacity J.kg ⁻¹ .K ⁻¹	Linear dilation coefficient from +20 °C to +100 °C 10 ⁻⁶ .K ⁻¹	Tensile strength Rm MPa
Bare copper	CuA1	180	400	1 083	8.89	1.7241	3.93	389	385	16.8	230
Deoxidised bare copper	CuC1	180	400	1 083	8.89	1.7241	3.93	389	385	16.8	230
Tin-plated copper	CuSn	180	300	1 083	8.89	1.7654 to 1.8508	3.66 to 3.84	386	385	16.8	230
Silver-plated copper	CuAg	200	450	1 083	8.91 to 9.05	1.7241	3.93 to 3.95	389	385	16.8	230
Nickel-plated copper	CuNi	300	500	1 083	8.89	1.7960	3.95	386	387	16.7	240
27% nickel-plated copper	CuNi27%	450	700	1 083	8.89	2.4284	4.22	359	404	15.8	240
Nickel	Ni	600	900	1 455	8.9	9.1	5.37	70	456	13	400
Nickel Chrome 80/20	NiCr80/20	1 000	1 200	1 400	8.35	108	0.06	11.3	450	17.5	800
Aluminium	Alu	120	200	660	2.7	2.8264	4.03	237	890	22	130
Galvanized steel	Galva	600	900	1 455	7.9	73	4	16.3	460	18	850
Stainless steel (AISI 304)	SS 304	600	900	1 455	7.9	73	4	16.3	460	18	850

**Maximum linear resistance
of cores at 20°C
As per IEC 60228**

Nominal cross-section mm ²	Maximum linear resistance of core at 20 °C (Ω/km)											
	Class 1 Bare strands Strands coated with metal layer		Minimum number of strands in core	Class 2 Bare strands Strands coated with metal layer		Aluminium strands	Class 5 Max. strand diameter in core (mm) Bare strands Strands coated with metal layer		Class 6 Max. strand diameter in core (mm) Bare strands Strands coated with metal layer			
0.5	36.0	36.7		7	36.0		36.7	-	0.21	39.0	40.1	0.16
0.75	24.5	24.8	7	24.5	24.8	-	0.21	26.0	26.7	0.16	26.0	26.7
1	18.1	18.2	7	18.1	18.2	-	0.21	19.5	20.0	0.16	19.5	20.0
1.5	12.1	12.2	7	12.1	12.2	-	0.26	13.3	13.7	0.16	13.3	13.7
2.5	7.41	7.56	7	7.41	7.56	-	0.26	7.98	8.21	0.16	7.98	8.21
4	4.61	4.70	7	4.61	4.70	-	0.31	4.95	5.09	0.16	4.95	5.09
6	3.08	3.11	7	3.08	3.11	-	0.31	3.30	3.39	0.21	3.30	3.39
10	1.83	1.84	7	1.83	1.84	3.08	0.41	1.91	1.95	0.21	1.91	1.95
16	1.15	1.16	7	1.15	1.16	1.91	0.41	1.21	1.24	0.21	1.21	1.24
25	-	-	7	0.727	0.734	1.20	0.41	0.780	0.795	0.21	0.780	0.795
35	-	-	7	0.524	0.529	0.868	0.41	0.554	0.565	0.21	0.554	0.565
50	-	-	19	0.387	0.391	0.641	0.41	0.386	0.393	0.31	0.386	0.393
70	-	-	19	0.268	0.270	0.443	0.51	0.272	0.277	0.31	0.272	0.277
95	-	-	19	0.193	0.195	0.320	0.51	0.206	0.210	0.31	0.206	0.210
120	-	-	37	0.153	0.154	0.253	0.51	0.161	0.164	0.31	0.161	0.164
150	-	-	37	0.124	0.126	0.206	0.51	0.129	0.132	0.31	0.129	0.132
185	-	-	37	0.0991	0.100	0.164	0.51	0.106	0.108	0.41	0.106	0.108
240	-	-	37	0.0754	0.0762	0.125	0.51	0.0801	0.0817	0.41	0.0801	0.0817
300	-	-	61	0.0601	0.0607	0.100	0.51	0.0641	0.0654	0.41	0.0641	0.0654
400	-	-	61	0.0470	0.0475	0.0778	0.51	0.0486	0.0495	-	-	-

**Maximum linear resistance
of cores at 20°C**
As per NF C 32-018

Maximum linear resistance of core at 20 °C (Ω/km)														
Nominal cross-section mm ²	Class A				Class B					Class C				
	Indicative stranding	Bare or silver-coated strands	Tin-plated strands	Nickel-plated strands	Indicative stranding	Min. number of strands in core	Bare or silver-coated strands	Tin-plated strands	Nickel-plated strands	Indicative stranding	Max. strand diameter in core (mm)	Bare or silver-coated strands	Tin-plated strands	Nickel-plated strands
0.03	1 x 0.20	599	616	662	-	-	-	-	-	-	-	-	-	-
0.05	1 x 0.25	384	394	424	-	-	-	-	-	-	-	-	-	-
0.055	-	-	-	-	7 x 0.10	7	373	391	419	-	-	-	-	-
0.06	-	-	-	-	-	-	-	-	-	15 x 0.07	0.08	356	372	399
0.08	1 x 0.32	230	234	252	7 x 0.12	7	252	259	279	10 x 0.10	0.11	261	274	293
0.12	1 x 0.40	146	148	160	7 x 0.15	7	161	166	178	15 x 0.10	0.11	174	182	195
0.15	-	-	-	-	-	-	-	-	-	19 x 0.10	0.11	136	143	153
0.20	1 x 0.50	93.1	95.0	102	-	-	-	-	-	-	-	-	-	-
0.22	-	-	-	-	7 x 0.20	7	89.9	92.5	99.4	19 x 0.12	0.13	92.0	94.6	102
0.28	1 x 0.60	64.7	65.9	71.0	-	-	-	-	-	-	-	-	-	-
0.34	-	-	-	-	7 x 0.25	7	57.5	59.2	63.6	19 x 0.15	0.16	58.9	60.6	65.1
0.40	-	-	-	-	-	-	-	-	-	12 x 0.20	0.21	52.4	53.9	58.0
0.50	1 x 0.80	36.0	36.7	39.5	7 x 0.30	7	39.6	40.7	43.8	16 x 0.20	0.21	39.0	40.1	43.1
0.60	-	-	-	-	-	-	-	-	-	19 x 0.20	0.21	32.8	33.7	36.3
0.64	1 x 0.90	28.5	29.0	31.2	-	-	-	-	-	-	-	-	-	-
0.75	-	-	-	-	-	-	-	-	-	24 x 0.20	0.21	26.0	26.7	28.7
0.80	1 x 1.00	23.1	23.3	-	-	-	-	-	-	-	-	-	-	-
0.93	-	-	-	-	19 x 0.25	19	21.0	21.6	23.2	-	-	-	-	-
1.00	1 x 1.13	18.1	18.2	-	-	-	-	-	-	32 x 0.20	0.21	19.5	20.0	21.5
1.13	1 x 1.20	16.0	16.2	-	-	-	-	-	-	-	-	-	-	-
1.34	-	-	-	-	19 x 0.30	19	14.6	15.0	16.1	-	-	-	-	-
1.50	-	-	-	-	-	-	-	-	-	30 x 0.25	0.26	13.3	13.7	14.7
1.91	-	-	-	-	27 x 0.30	27	10.3	10.6	11.3	-	-	-	-	-
2.61	-	-	-	-	37 x 0.30	37	7.49	7.70	8.28	-	-	-	-	-

Maximum linear resistance of core at 20 °C (Ω/km)					
Nominal cross-section mm ²	Indicative stranding	Max. strand diameter in core (mm)	Class D		
			Bare or silver-coated strands	Tin-plated strands	Nickel-plated strands
0.03	-	-	-	-	-
0.05	-	-	-	-	-
0.055	27 x 0.05	0.06	387	405	434
0.06	-	-	-	-	-
0.08	19 x 0.07	0.08	281	294	315
0.12	30 x 0.07	0.08	178	186	199
0.15	37 x 0.07	0.08	143	149	160
0.20	-	-	-	-	-
0.22	27 x 0.10	0.11	95.9	100	108
0.28	-	-	-	-	-
0.34	30 x 0.12	0.13	58.3	59.9	64.4
0.40	-	-	-	-	-
0.50	28 x 0.15	0.16	39.6	40.7	43.8
0.60	-	-	-	-	-
0.64	-	-	-	-	-
0.75	42 x 0.15	0.16	26.4	27.1	29.2
0.80	-	-	-	-	-
0.93	-	-	-	-	-
1.00	56 x 0.15	0.16	19.8	20.4	21.9
1.13	-	-	-	-	-
1.34	-	-	-	-	-
1.50	83 x 0.15	0.16	13.3	13.7	14.8
1.91	-	-	-	-	-
2.61	-	-	-	-	-

**Maximum linear resistance
of cores at 20°C**
As per UL 1581

Nominal cross-section (mm ²)	Maximum linear resistance of core at 20 °C (Ω/km)		
	Single-strand bare copper conductor UL 1581 - Table 30.1	Single-strand tin-plated copper conductor UL 1581 - Table 30.2	Multi-strand bare copper conductor UL 1581 - Table 30.3
30 AWG	347	361	354
29 AWG	271	282	277
28 AWG	218	227	223
27 AWG	172	179	175
26 AWG	138	143	140
25 AWG	108	112	111
24 AWG	85.9	89.3	87.6
23 AWG	67.9	70.6	69.2
22 AWG	54.3	56.4	55.4
21 AWG	42.7	44.4	43.6
20 AWG	33.9	35.2	34.6
19 AWG	26.9	28.0	27.4
18 AWG	21.4	22.2	21.8
17 AWG	16.9	17.6	17.3
16 AWG	13.5	14.0	13.7
15 AWG	10.6	11.1	10.9
14 AWG	8.45	8.78	8.62
13 AWG	6.69	6.97	6.82
12 AWG	5.31	5.53	5.43
11 AWG	4.22	4.39	4.30
10 AWG	3.343	3.476	3.409
9 AWG	2.652	2.730	2.705
8 AWG	2.102	2.163	2.144
7 AWG	1.667	1.716	1.700
6 AWG	1.323	1.361	1.348
5 AWG	1.049	1.079	1.070
4 AWG	0.8315	0.8559	0.8481
3 AWG	0.6595	0.6788	0.6727
2 AWG	0.5231	0.5384	0.5335
1 AWG	0.4146	0.4268	0.4230
1/0 AWG	0.3287	0.3367	0.3354
2/0 AWG	0.2608	0.2670	0.2660
3/0 AWG	0.2069	0.2119	0.2110
4/0 AWG	0.1640	0.1680	0.1673
250 kcmil	-	-	0.1416
300 kcmil	-	-	0.1180
350 kcmil	-	-	0.1011
400 kcmil	-	-	0.08851
450 kcmil	-	-	0.07867
500 kcmil	-	-	0.7080
550 kcmil	-	-	0.06436
600 kcmil	-	-	0.05900
650 kcmil	-	-	0.05447
700 kcmil	-	-	0.05057
750 kcmil	-	-	0.04721
800 kcmil	-	-	0.04425
900 kcmil	-	-	0.03933
1000 kcmil	-	-	0.03540

Conductor metal	Strand diameter (mm)	Correction coefficient Kc
CuAl (as per ASTM B 3)	-	1
CuAg (as per ASTM B 298)	-	1
CuSn (as per ASTM B 33)	0.076 ≤ Ø < 0.28	0.9315
	0.28 ≤ Ø < 0.51	0.9416
	0.51 ≤ Ø < 2.6	0.9616
	2.6 ≤ Ø < 7.4	0.9716
	7.4 ≤ Ø < 11.7	0.9766
CuNi (as per ASTM B 355)	-	0.96
CuNi27% (as per ASTM B 355)	-	0.71

To determine the maximum linear resistance at 20 °C of the cores made of the metals above, the following formula is applied:

$$R_{linmax\ metal} = R_{linmax\ CuAl} / Kc$$

**Main properties
of insulation materials commonly
used by OMERIN SAS:**

Properties	Polyvinyl chloride	low density	Polyethylene high density	chemically cross-linked	Halogen-free polyolefine	Polyurethane	Ethylene tetrafluoro-ethylene	Fluorethylene propylene	Perfluoro-alkoxy alkane	Polytetrafluoro-ethylene	Polyimide	Silicone rubber	VARPREN®
	PVC	LDPE	HDPE	XLPE	HFFR	PUR	ETFE	FEP	PFA	PTFE	PI	SIR	VARPREN®
Physical													
Operating temperature:													
- at low temperature (°C)	-30	-50	-50	-50	-30	-50	-90	-90	-90	-90	-90	-60	-30
- in continuous operating service (°C)	+105	+70	+80	+90	+105	+120	+150	+205	+260	+260	+260	+180	+155
- in short circuit state (°C)	+160	+150	+180	+250	+160	+180	+200	+250	+300	+300	+350	+350	+200
Density (g/cm ³)	1.23 to 1.50	0.91	0.93	0.91	1.5	1.11 to 1.18	1.75	2.15	2.15	2.15	1.67	1.20 to 1.50	1.45 to 1.57
Electrical													
Dielectric strength (kV/mm)	30	20	20	25	20	20	36	24	25	25	28	25	15
Electrical resistance (Ω.cm)	10 ¹⁶	10 ¹⁷	10 ¹⁷	10 ¹⁷	10 ¹⁵	10 ¹⁵	10 ¹⁶	10 ¹⁸	10 ¹⁸	10 ¹⁸	10 ¹⁵	10 ¹⁵	10 ¹⁴
Relative permittivity at industrial frequency	8	2.3	2.3	2.5	3.6	6	2.6	2.1	2.05	2	2.7	3.22 to 3.67	5
tan δ at industrial frequency (x 10 ⁻⁴)	1 000	10	10	40	20	300	2	3	2	2	13	37 to 258	200
Chemical													
Resistance to weak acids	Very good	Very good	Very good	Very good	Fair	Very good	Very good	Very good	Very good	Very good	Very good	Good	Good
Resistance to weak alkalis	Very good	Very good	Very good	Very good	Fair	Very good	Very good	Very good	Very good	Very good	Good	Good	Good
Mechanical													
Flexibility	Good	Medium	Poor	Medium	Poor	Good	Medium	Medium	Good	Poor	Medium	Excellent	Excellent
Resistance to abrasion.	Good	Medium	Good	Good	Good	Excellent	Excellent	Medium	Good	Good	Excellent	Good	Good
Tensile strength (MPa)	15	10	20	22	12	50	45	20	27.5	40	18	5	6
Elongation at break (%)	250	400	500	300	180	350	200	250	300	350	70	200	300
Other													
Flame resistance	Medium	Poor	Poor	Poor	Excellent	Medium	Excellent	Excellent	Excellent	Excellent	Excellent	Good	Good
Halogen-free	No	Yes	Yes	Yes	Yes	Yes	No	No	No	No	No	Yes	Yes
Thermal resistivity (K.m/W)	5	3.5	3.5	3.5	5	5	4.4	5	4.4	4.5	5	5	5
Steam resistance	Poor	Poor	Poor	Fair	Poor	Poor	Good	Excellent	Excellent	Excellent	Fair	Good	Poor

Note: The information given above is purely indicative and testing under operating conditions as close as possible to reality is preferable. In no event shall OMERIN be held liable. Our technical departments are at your service to provide any clarifications required.

**Resistance fluorinated insulation
to chemical products**

	FEP and PTFE	PFA	ETFE
Hydrocarbons (oils, petrol, greases, etc.)	Excellent	Excellent	Excellent
Weak acids	Excellent	Excellent	Excellent
Strong acids	Excellent	Excellent	Very good (except for highly oxidant acids when boiling)
Weak alkalis	Excellent	Excellent	Excellent
Strong alkalis	Very good (except hot alkaline metals)	Excellent	Very good (except very strong alkalis at high temperatures)
Organic solvents	Very good except some halogenated solvents that may cause softening at high temperature and pressure.	Excellent	Excellent

Fluorinated insulation materials are known to be highly resistant to chemical products such as solvents or hydrocarbons, but they are also capable of resisting all other types of aggressive or corrosive environments. The table below indicates the degrees of resistance of fluorinated insulation materials to chemical products with varying corrosive properties. For further information about fluorinated insulation materials, contact our technical department.

Thermal classification of insulations

Temperature class

- Y: 90 °C • A: 105 °C • E: 120 °C • B: 130 °C • F: 155 °C • H: 180 °C • C: > 180 °C

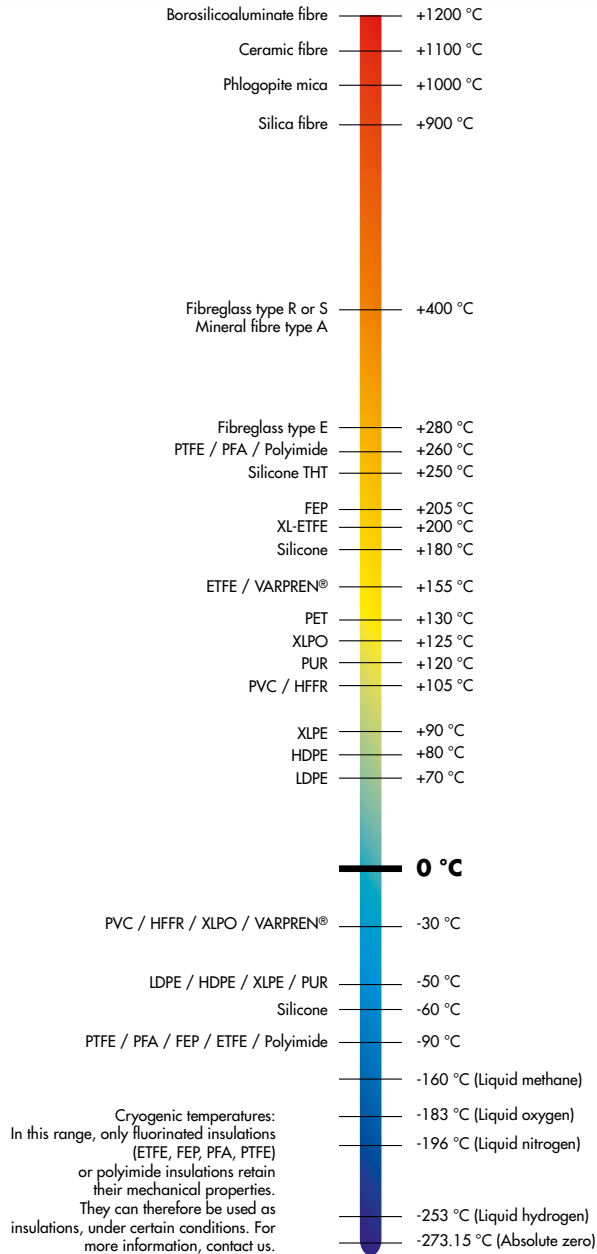

General

Introduction

The heat produced by the Joule effect when a current flows through the conductor core, is conducted by the various external insulating layers to be finally dissipated by the external cable environment.

This dissipation of heat via the external environment of the cable is done either by:

- convection and radiation if the cable is installed in the open air.
- conduction if the cable is in contact with other elements or materials.

When the thermal losses produced are equal to the thermal losses dissipated in the surrounding medium, a state of balance is achieved, characterised by a constant core temperature (steady state). This temperature must not exceed the maximum supported by the insulation, to ensure the cable has an optimum lifetime.

The maximum permissible current under continuous operation is the current strength value which, for a clearly defined cable environment, provokes the heating of the conductor cores to the maximum permitted value.

Calculations of permissible current as per IEC 60287

Title of IEC 60287

"Calculation of the continuous current rating of cables (100% load factor)"

Field of application of IEC 60287

This standard only concerns the permanent use operation of cables for all alternating and direct voltages up to 5 kV, buried directly underground, installed in liners, gutters or steel tubes, as well as cables installed in the open air. In IEC 60287, "permanent use" is understood to mean the continuous circulation of a sufficient constant current (load factor 100%) to asymptotically achieve the maximum conductor temperature, assuming that the conditions of the ambient environment remain unchanged.

Basic assumptions for calculating permissible currents under IEC 60287

- Copper or aluminium core(s).
- Insulation class "maximum temperature resistance of insulation"
- Insulated cable in open air resting on supports or flanges.
- Outer cable diameter less than 150 mm.
- Cable protected from direct sunlight.
- AC (F = 50 Hz) or DC \leq 5000 V.
- Suitable thermal dissipation and ventilation in the immediate vicinity of the cable.
- No external heat sources in the immediate vicinity of the cable.

Observations

The values indicated in the tables, graphs or calculations are indicative and theoretical.

They must only be used as estimations or as a starting point for a more detailed experimentation plan.

Indeed, these values can vary significantly according to core stranding options, the type of insulation, the number of conductors, the environmental conditions, the conditions of installation, etc.

Our technical departments are at your service for further and more detailed analyses.

Complements

Correction factors

The calculations of maximum permissible current strength according to IEC 60287 result in graph curves that can be downloaded directly from our website, www.omerin.com. Today a large majority of OMERIN products have their own maximum permissible current graphs. However, if you are unable to find the right one or access the graphs, please contact us.

These graphs are given for specific cable installation conditions (blue box on upper right of graph: see basic assumptions on previous page). For other conditions of installation, you may apply the correction factors given below.

To select the correct dimensioning of your cables, apply the following formula and select the dimensions according to the correction:

$$I_{\text{corrected}} = (I_{\text{application}} / K) / (\text{number of cables per phase})$$

Correction factors for several single-core cables or multicore cables

Layout of sealed cables	Correction factors										
	Number of single or multicore cables										
	2	3	4	5	6	7	8	9	12	16	20
Enclosed	0.8	0.7	0.65	0.6	0.55	0.55	0.5	0.5	0.45	0.4	0.4
Single layer on walls or floors or non-perforated trays	0.85	0.79	0.75	0.73	0.72	0.72	0.71	0.7	0.7	0.7	0.7
Single layer on ceiling	0.85	0.76	0.72	0.69	0.67	0.66	0.65	0.64	0.64	0.64	0.64
Single layer on perforated horizontal or vertical trays	0.88	0.82	0.77	0.75	0.73	0.73	0.72	0.72	0.72	0.72	0.72
Single layer on cable raceways, gutters, welded frames, etc.	0.88	0.82	0.8	0.8	0.79	0.79	0.78	0.78	0.78	0.78	0.78

Correction factors for installation in several layers

Number of layers	1	2	3	4	5	6	7	8	>9
Coefficient	1	0.8	0.73	0.7	0.7	0.68	0.68	0.68	0.66

Equivalences between standards

	Standards			
	NF	EN	IEC	
FIRE RESISTANCE				
Circuit integrity			60331-1	Test method for fire with shock at a temperature of at least 830 °C for cables of rated voltage up to and including 0.6/1.0 kV and with an overall diameter exceeding 20 mm
			60331-2	Test method for fire with shock at a temperature of at least 830 °C for cables of rated voltage up to and including 0.6/1.0 kV and with an overall diameter not exceeding 20 mm
			60331-3	Test method for fire with shock at a temperature of at least 830 °C for cables of rated voltage up to and including 0.6/1.0 kV tested in a metal enclosure
			60331-11	Apparatus - Fire alone at a flame temperature of at least 750 °C
			60331-21	Procedures and requirements - Cables of rated voltage up to and including 0.6/1.0 kV
			60331-23 60331-25	Procedures and requirements - Electric data cables Procedures and requirements - Optical fibre cables
CR1 test	C 32-070			Tests for classification of conductors and cables with respect to their fire behaviour
Test on small conductors	C 32-076	50200		Method of test for resistance to fire of unprotected small cables for use in emergency circuits
Test on large conductors	C 32-077	50362		Method of test for resistance to fire of larger unprotected power and control cables for use in emergency circuits
FLAME PROPAGATION				
Cable alone:				
Vertical flame	C 32-078-1-1	60332-1-1	60332-1-1	Test for a vertical flame propagation for a single insulated wire or cable - Apparatus
	C 32-078-1-2	60332-1-2	60332-1-2	Test for vertical flame propagation for a single insulated wire or cable - Procedure for 1 kW pre-mixed flame
	C 32-078-1-3	60332-1-3	60332-1-3	Test for vertical flame propagation for a single insulated wire or cable - Procedure for determination of flaming droplets/particles
C2 test	C 32-070			Tests for classification of conductors and cables with respect to their fire behaviour
Vertical flame on small conductor	C 32-078-2-1	60332-2-1	60332-2-1	Test for vertical flame propagation for a single small insulated wire or cable - Apparatus
	C 32-078-2-2	60332-2-2	60332-2-2	Test for vertical flame propagation for a single small insulated wire or cable - Procedure for diffusion flame
Bunched cable:				
	C 32-078-3-10	60332-3-10	60332-3-10	Test for vertical flame spread of vertically-mounted bunched wires or cables - Apparatus
	C 32-078-3-21	60332-3-21	60332-3-21	Test for vertical flame spread of vertically-mounted bunched wires or cables - Category A F/R
	C 32-078-3-22	60332-3-22	60332-3-22	Test for vertical flame spread of vertically-mounted bunched wires or cables - Category A
	C 32-078-3-23	60332-3-23	60332-3-23	Test for vertical flame spread of vertically-mounted bunched wires or cables - Category B
	C 32-078-3-24	60332-3-24	60332-3-24	Test for vertical flame spread of vertically-mounted bunched wires or cables - Category C
	C 32-078-3-25	60332-3-25	60332-3-25	Test for vertical flame spread of vertically-mounted bunched wires or cables - Category D
FIRE PROPAGATION				
C1 test	C 32-070			Tests to classify conductors and cables according to their fire behaviour - C1 test
SMOKE DENSITY				
	C 32-073-1	61034-1	61034-1	Test apparatus
	C 32-073-2	61034-2	61034-2	Test procedure and requirements
	X 10-702-1			Determination of the opacity of the fumes in an atmosphere without air renewal - Apparatus
	X 10-702-2			Determination of the opacity of the fumes in an atmosphere without air renewal - Test method
COMBUSTION GASES				
	C 32-074-1	60754-1	60754-1	Determination of halogen acid gas content
	C 32-074-2	60754-2	60754-2	Determination of acidity (by pH measurement) and conductivity
	X 70-100			Analysis of pyrolysis and combustion gases - Tubular furnace method
	X 70-101			Analysis of pyrolysis and combustion gases - Smoke chamber method
	C 20-453			Conventional determination of smoke corrosiveness
	C 20-454			Analysis and titrations of gases evolved during pyrolysis or combustion of materials used in electrotechnical systems

Description of some tests

Test: Vertical flame spread on insulated cable as per IEC 60332-1-2 - Test C2 as per NF C 32-070

Length of specimen: 600 mm.
Burner characteristics: as per IEC 60322-1-1
Properties of flame: 1 kW.
Position of specimen: vertical
Flame position: 45° from the vertical axis of the specimen and 475 mm from the bottom of the lower support.
Flame application time: see table below.

Acceptance criteria:

- The cable must be self-extinguishing.
- The carbonised zone must not be within 50 mm of the bottom of the upper support.
- The carbonised zone must not be more than 540 mm from the bottom of the upper support.

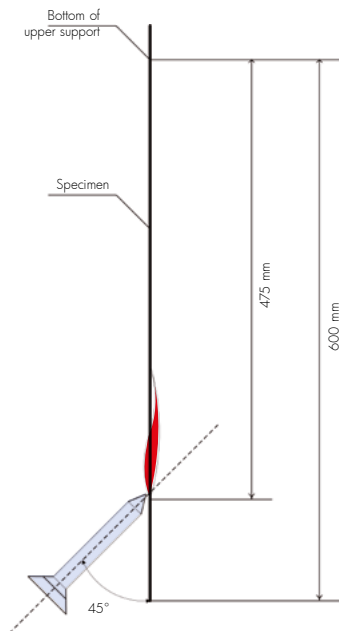

Outer diameter of specimen mm	Flame application time s
$D \leq 25$	60
$25 < D \leq 50$	120
$50 < D \leq 75$	240
$D > 75$	480

Note: When non-circular cables are tested (e.g. flat cables), the circumference is measured and used to calculate an equivalent diameter as if the cable was circular.

Test: Fire propagation - C1 test as per NF C 32-070

Length of specimen: 1600 mm.
Number of sections per specimen: according to cable diameter
Properties of flame: 1 kW.
Position of specimen: vertical
Test temperature: 800 °C.
Duration: 30 min.

Acceptance criteria:

- The part of the specimen beyond the upper end of the chimney must present no traces of combustion.

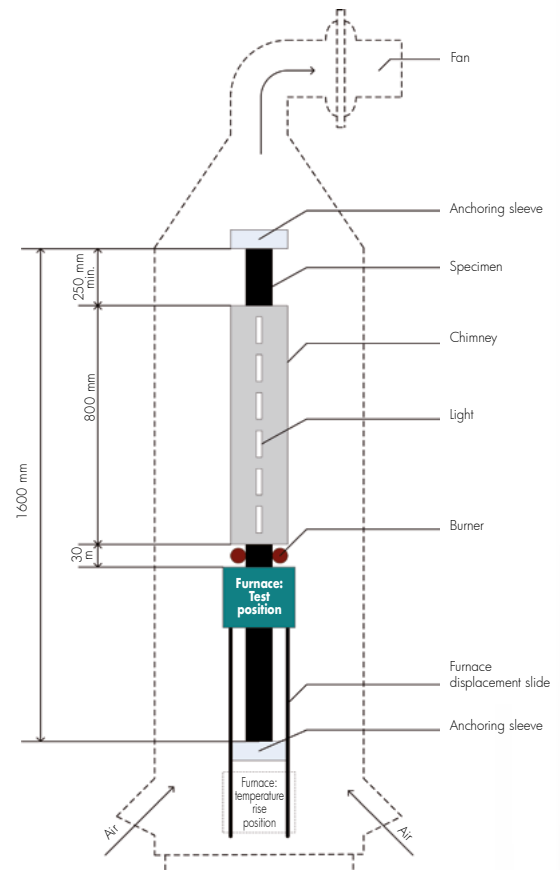

EUROCLASSES

The new European reaction-to-fire classification⁽¹⁾ for cables as per the Construction Products Regulation (CPR): "EUROCLASSES"

Faced with all fire risks, in 2006 the European Union decided to include cables in the Construction Products Directive (CPD). A classification of fire reaction characteristics of cables was published in the Official Journal of the European Union on 27 October 2006 to endorse this decision. These Euroclasses relate to both power and communication cables, in all types of building - residential, commercial and industrial. The new classification represents significant progress for the safety of people and property, as it considers the overall performance of cables in a fire.

MORE ACCURATE CLASSIFICATION

Table 52A in standard NF C 15-100 currently lists the conductors and cables commonly used in an electrical installation. The table indicates especially the fire reaction characteristics for each cable (C1, C2 or C3). This French classification is set out by the Order of 21 July 1994 which, apart from the classes, lays down the certificate of compliance of the fire performance of electric conductors and cables. It is going to be replaced gradually by the European classification that will have seven classes: A, B1, B2, C, D, E and F, A is the most demanding level.

The public authorities must adapt the French regulations to the European requirements and amend the Order of 21 July 1994 to apply this new classification in France. The regulations on different types of building will then be reviewed to clarify the application of the Euroclasses. The Euroclasses will take time to become applicable. The tests on cables in terms of their fire performance must first be harmonised at European level. Several standards have therefore been prepared:

- Standard EN 50399, which defines the new test methods that supplement certain methods already in existence.
- Standard EN 13501-6, which translates the Euroclass classification. This is at the final voting stage in the relevant Technical Committee of the CEN.
- The "harmonised products" standard EN 50575, which sets out the essential requirements for the assessment and declaration of performance, the initial tests, the monitoring and the marking of products.

Once all these standards have been published and the public authorities have notified the European Commission about which bodies are approved for product certification, the certified products will then gradually appear in the marketplace bearing the CE markings and the statement of the Euroclass achieved. The French classification and the Euroclasses will operate side-by-side for a certain period. Subsequently, the CE markings and performance declarations will be mandatory.

EUROCLASS	CLASSIFICATION CRITERIA	ADDITIONAL CRITERIA
A ^{ca}	Fire load	
B1 ^{ca}	Heat release + Vertical spread in bunched cables + Flame spread	Smoke emissions (s1, s1a, s1b, s2, s3)
B2 ^{ca}		Flaming droplets (d0, d1, d2)
C ^{ca}		Acidity (a1, a2, a3)
D ^{ca}		
E ^{ca}	Flame spread	
F ^{ca}		

EUROCLASS CLASSIFICATION CRITERIA

Fire load

Aca = Non-combustible (glass, silica, etc.)
B1ca = Combustible non-flammable
B2ca = Combustible low flammability
Cca = Combustible low flammability
Dca = Combustible moderate flammability
Eca = Combustible high flammability
Fca = not classified

Smoke opacity

(based on quantity and speed of production)
s1 = small quantity and slow production speed
s2 = moderate quantity and production speed
s3 = large quantity and fast production speed
s1a = results in better light transmittance than s1b

Flaming droplets and debris

d0: no debris
d1: no debris that burns for more than ten seconds
d2: debris that burns for more than ten seconds

Acidity and conductivity

a1: low conductivity and low acidity of solubilised combustion gases
a2: relatively low conductivity and low acidity of solubilised combustion gases
a3: high conductivity and acidity of solubilised combustion gases

(1) Caution, the reaction to fire relates to the performance of the cable when it is burning. It does not refer to its ability to do its work for a limited time in a fire (the term in this case is resistance to fire).

www.omerin.com

List of standards

ANSI/IEEE 383	IEEE Standard for Qualifying Class 1E Electric Cables and Field Splices for Nuclear Power Generating Stations	NF C 31-111	conductors in bare or tinned, cold-hardened or annealed copper, of circular cross-section obtained by single-filament or multi-filament drawing
ASTM B 3	Standard Specification for Soft or Annealed Copper Wire	CR1 test	Tests for classification of conductors and cables with respect to their fire behaviour
ASTM B 8	Standard Specification for Concentric-Lay-Stranded Copper Conductors, Hard, Medium-Hard, or Soft	NF C 42-323	Electric measurement devices - identification of thermocouples
ASTM B33	Standard Specification for Tin-Coated Copper or Annealed Copper Wire for Electrical Purposes	NF C 42-324	Extension and compensation cables for thermocouples
ASTM B 160	Standard Specification for Nickel Rod and Bar	NF C 93-521	Electronic components: Low frequency equipment wires and cables with solid or stranded conductors, PVC insulation and sheath.
ASTM B 170	Standard Specification for Oxygen-Free Electrolytic Copper - Refinery Shapes	NF C 93-523	Electronic components: Insulated wires for high temperatures
ASTM B 172	Standard Specification for Rope-Lay-Stranded Copper Conductors Having Bunch-Stranded Members, for Electrical Conductors	NF C 93-524	Electronic components: Insulated wires for high temperatures up to 150 °C
ASTM B 173	Standard Specification for Rope-Lay-Stranded Copper Conductors Having Concentric-Stranded Members, for Electrical Conductors	NF EN 13601	Copper and copper alloys - Copper rod, bar and wire for general electrical purposes
ASTM B 174	Standard Specification for Bunch-Stranded Copper Conductors for Electrical Conductors	NF EN 13602	Copper and copper alloys - Drawn, round copper wire for the manufacture of electrical conductors
ASTM B 193	Standard Test Method for Resistivity of Electrical Conductor Materials	NF EN 13603	Copper and copper alloys - Test methods for assessing protective tin coatings on drawn round copper wire for electrical purposes
ASTM B 298	Standard Specification for Silver-Coated Soft or Annealed Copper Wire	NF EN 50143	Cables for illuminated signs and illuminated discharge tubes
ASTM B 355	Standard Specification for Nickel-Coated Soft or Annealed Copper Wire	NF EN 50200	Method of test for resistance to fire of unprotected small cables for use in emergency circuits
ASTM D149	Standard Test Method for Dielectric Breakdown Voltage and Dielectric Strength of Solid Electrical Insulating Materials at Commercial Power Frequencies	NF EN 50264	Railway applications - Railway rolling stock power and control cables having special fire performance
CSA C22.2 210	Appliance wiring material products	NF EN 50305	Railway applications - Railway rolling stock cables having special fire performance - Test methods
DIN 17740	Wrought nickel, chemical composition	NF EN 50306	Railway applications - Railway rolling stock cables having special fire performance - Thin wall
DIN 17753	Wrought nickel and nickel alloy wires, characteristics	NF EN 50343	Railway applications - Rolling stock - Rules for installation of cabling
DIN 40620	Varnished sleeveings (flexible with textile) used for electrical insulation	NF EN 50362	Method of test for resistance to fire of larger unprotected power and control cables for use in emergency circuits
DIN 40628	Sleeving based on silicone rubber	NF EN 50363	Insulating, sheathing and covering materials for low-voltage energy cables
DIN 43712	Measurement and Control; electrical temperature sensors; wires for thermocouples	NF EN 50382	Railway applications - Railway rolling stock high temperature power cables having special fire performance
DIN 43713	Electrical temperature sensors; wires and stranded wires for extension and compensating cables	NF EN 50395	Electrical test methods for low voltage energy cables
DIN 43714	Measurement and Control; electrical temperature sensors; compensating cables for thermocouples	NF EN 50396	Non-electrical test methods for low voltage energy cables
DIN 43760	Measurement and Control: Electrical Temperature Sensors	NF EN 50525	Electric cables - Low voltage energy cables of rated voltages up to and including 450/750 V (U0/U)
HD 308	Identification of cores in cables and flexible cords	NF EN 60228	Conductors of insulated cables
HD 361	System for cable designation	NF EN 60335	Household and similar electrical appliances - Safety
IEC 60079	Electrical apparatus for explosive gas atmospheres	NF EN 60584	Thermocouples
IEC 60085	Electrical insulation - Thermal evaluation and designation	NF EN 60598	Luminaires
IEC 60092	Electrical installations in ships	NF EN 60754	Tests on gases evolved during combustion of materials from cables
IEC 60189	Low-frequency cables with PVC insulation and PVC sheath	NF EN 61034	Measurement of smoke density of cables burning under defined conditions
IEC 60227	Polyvinyl chloride insulated cables of rated voltages up to and including 450/750 V	NF EN 62230	Electric cables - Spark-test method
IEC 60228	Conductors of insulated cables	NF F 16-101	Rolling stock. Fire behaviour. Materials selection
IEC 60245	Rubber insulated cables - Rated voltages up to and including 450/750 V	NF C 87-201	Oil industry - Extension and compensation cables for thermocouples - Specifications
IEC 60287	Electric cables - Calculation of the current rating	NF C 87-202	Oil industry - Instrumentation cables - Specifications
IEC 60331	Tests for electric cables under fire conditions - Circuit integrity	NF X 10-702	Fire test methods. Determination of the opacity of the fumes in an atmosphere without air renewal
IEC 60332	Tests on electric and optical fibre cables under fire conditions	NF X 70-100	Fire tests - Analysis of gaseous effluents
IEC 60502	Power cables with extruded insulation and their accessories for rated voltages from 1 kV (Um = 1.2 kV) up to 30 kV (Um = 36 kV)	NF X 70-101	Fire tests - Analysis of gaseous effluents
IEC 60584	Thermocouples	UL 94	Tests for Flammability of Plastic Materials for Parts in Devices and Appliances
IEC 60695	Fire hazard testing	UL 758	Appliance Wiring Material
IEC 60751	Industrial platinum resistance thermometers	UL 1441	Coated Electrical Slewing
IEC 60754	Tests on gases evolved during combustion of materials from cables	UL 1581	Reference Standard for Electrical Wires, Cables, and Flexible Cords
IEC 60811	Electric and optical fibre cables - Test methods for non-metallic materials	UTE C 93-521	Electronic components. Low frequency equipment wires and cables with solid or stranded conductors, PVC insulation and sheath
IEC 60949	Calculation of thermally permissible short-circuit currents, taking into account non-adiabatic heating effects	UTE C 93-523	Electronic components. Insulated wires for high temperatures
IEC 61034	Measurement of smoke density of cables burning under defined conditions	UTE C 93-524	Electronic components. Insulated wires for high temperatures up to 150 °C
IEC 62230	Electric cables - Spark-test method	VDE 0207	Insulating and sheathing compounds for cables and flexible cords
JIS C 1602	Thermocouples	VDE 0250	Cables, wires and flexible cords for power installations
JIS C 1610	Compensating Lead Wires	VDE 0472	Testing of cables, wires and flexible cords
MIL-W-22759	Military Specification Sheet : Wire, Electric, Fluoropolymer-insulated		
NF C 15-100	Low voltage electrical installations		
NF C 20-453	Basic environmental testing procedures - Test methods. Conventional determination of corrosiveness of smoke		
NF C 20-454	Analysis and titrations of gases evolved during pyrolysis or combustion of materials used in electro-technical systems		
NF C 32-018	Conductors of small wires and cables		

Names and symbols

As per NF X 02-004

In this paragraph, we provide examples of usual physical quantities with the corresponding units and symbols, along with the expression of derived units in base units and supplementary units.

Physical quantities and base units of the International system of units

PHYSICAL QUANTITY	UNIT	SYMBOL
length	metre	m
mass	kilogram	kg
time	second	s
electrical current strength	ampere	A
thermodynamic temperature	Kelvin	K
quantity of material	mole	mol
light intensity	candela	cd

Note: The temperature in Celsius t is associated to the thermodynamic temperature T via the relationship $t = T - 273.15$

A temperature interval may be expressed either in Kelvins or in degrees Celsius.

In this case, $1\text{ }^\circ\text{C} = 1\text{ K}$

Supplementary physical quantities and units of the international system (which may be used as quantities and base units)

PHYSICAL QUANTITY	UNIT	SYMBOL
plane angle	radian	rad
solid angle	steradian	sr

Table presenting the main multiples and sub-multiples of units of measurement

Factor	MULTIPLES	
	Prefix	Symbol
10^{18}	exa	E
10^{15}	peta	P
10^{12}	tera	T
10^9	giga	G
10^6	mega	M
10^3	kilo	k
10^2	hecto	h
10^1	deca	da
SUB-MULTIPLES		
10^{-1}	deci	d
10^{-2}	centi	c
10^{-3}	milli	m
10^{-6}	micro	μ
10^{-9}	nano	n
10^{-12}	pico	p
10^{-15}	femto	f
10^{-18}	atto	a

Some quantities and derived units of the International system of units:

	PHYSICAL QUANTITY	UNIT		IN BASE UNITS
		NAME	SYMBOL	
SPACE TIME	surface area	square metre	m^2	m^2
	volume	cubic metre	m^3	m^3
	angular speed	radian per second	rad/s	$\text{rad}\cdot\text{s}^{-1}$
	speed	metre per second	m/s	$\text{m}\cdot\text{s}^{-1}$
	acceleration	metre per squared second	m/s^2	$\text{m}\cdot\text{s}^{-2}$
	frequency	hertz	Hz	s^{-1}
	frequency of rotation	second to the power minus 1	s^{-1}	s^{-1}
MECHANICAL	density	kilogram per cubic metre	kg/m^3	$\text{kg}\cdot\text{m}^{-3}$
	mass flow	kilogram per second	kg/s	$\text{kg}\cdot\text{s}^{-1}$
	volume flow	cubic metre per second	m^3/s	$\text{m}^3\cdot\text{s}^{-1}$
	quantity of movement	kilogram-metre per second	$\text{kg}\cdot\text{m/s}$	$\text{kg}\cdot\text{m}\cdot\text{s}^{-1}$
	kinetic moment	kilogram-metre squared per second	$\text{kg}\cdot\text{m}^2/\text{s}$	$\text{kg}\cdot\text{m}^2\cdot\text{s}^{-1}$
	moment of inertia	kilogram-metre squared	$\text{kg}\cdot\text{m}^2$	$\text{kg}\cdot\text{m}^2$
	force	Newton	N	$\text{kg}\cdot\text{m}\cdot\text{s}^{-2}$
	moment of force	Newton-metre	$\text{N}\cdot\text{m}$	$\text{kg}\cdot\text{m}^2\cdot\text{s}^{-2}$
	pressure, stress	Pascal	Pa	$\text{kg}\cdot\text{m}^{-1}\cdot\text{s}^{-2}$
	dynamic viscosity	Pascal-second	$\text{Pa}\cdot\text{s}$	$\text{kg}\cdot\text{m}^{-1}\cdot\text{s}^{-1}$
	kinematic viscosity	square metre per second	m^2/s	$\text{m}^2\cdot\text{s}^{-1}$
	surface tension	Newton per metre	N/m	$\text{kg}\cdot\text{s}^{-2}$
	energy, work, heat	joule	J	$\text{kg}\cdot\text{m}^2\cdot\text{s}^{-2}$
power, energy flow	watt	W	$\text{kg}\cdot\text{m}^2\cdot\text{s}^{-3}$	
THERMO-DYNAMIC	linear dilation coefficient	Kelvin to the power minus 1	K^{-1}	K^{-1}
	Thermal conductivity	watt per metre-Kelvin	$\text{W}/(\text{m}\cdot\text{K})$	$\text{kg}\cdot\text{m}\cdot\text{K}^{-1}\cdot\text{s}^{-3}$
	Specific heat capacity	joule per kilogram-Kelvin	$\text{J}/(\text{kg}\cdot\text{K})$	$\text{m}^2\cdot\text{K}^{-1}\cdot\text{s}^{-2}$
	entropy	joule per Kelvin	J/K	$\text{kg}\cdot\text{m}^2\cdot\text{K}^{-1}\cdot\text{s}^{-2}$
	internal energy, enthalpy free energy, free enthalpy	joule	J	$\text{kg}\cdot\text{m}^2\cdot\text{s}^{-2}$
OPTICAL	light flow	lumen	lm	$\text{cd}\cdot\text{sr}$
	luminous luminescence	candela per cubic metre	cd/m^3	$\text{cd}\cdot\text{m}^{-3}$
	luminous exitance	lumen per cubic metre	lm/m^2	$\text{cd}\cdot\text{sr}\cdot\text{m}^{-2}$
	illumination	lux	lx	$\text{cd}\cdot\text{sr}\cdot\text{m}^{-2}$
	luminous exposure	lux-second	$\text{lx}\cdot\text{s}$	$\text{cd}\cdot\text{sr}\cdot\text{s}\cdot\text{m}^{-2}$
	luminous efficiency	lumen per watt	lm/W	$\text{cd}\cdot\text{sr}\cdot\text{s}^3\cdot\text{kg}^{-1}\cdot\text{m}^{-2}$
	electrical charge, quantity of electricity	coulomb	C	A·s
ELECTRICITY MAGNETISM	electrical field	volt per metre	V/m	$\text{m}\cdot\text{kg}\cdot\text{A}^{-1}\cdot\text{s}^{-3}$
	potential difference, voltage, electromotive force	volt	V	$\text{kg}\cdot\text{m}^2\cdot\text{A}^{-1}\cdot\text{s}^{-3}$
	capacity	farad	F	$\text{A}^2\cdot\text{s}^4\cdot\text{kg}^{-1}\cdot\text{m}^{-2}$
	magnetic field	ampere per metre	A/m	$\text{A}\cdot\text{m}^{-1}$
	magnetic induction	Tesla	T	$\text{kg}\cdot\text{A}^{-1}\cdot\text{s}^{-2}$
	magnetic induction flow	Weber	Wb	$\text{kg}\cdot\text{m}^2\cdot\text{A}^{-1}\cdot\text{s}^{-2}$
	inductance, permeance	Henry	H	$\text{kg}\cdot\text{m}^2\cdot\text{A}^{-2}\cdot\text{s}^{-2}$
	reluctance	Henry to the power minus 1	H^{-1}	$\text{A}^2\cdot\text{s}^2\cdot\text{kg}^{-1}\cdot\text{m}^{-2}$
	resistance, impedance, reactance	ohm	Ω	$\text{kg}\cdot\text{m}^2\cdot\text{A}^{-2}\cdot\text{s}^{-3}$
	conductance, admittance, susceptance	siemens	S	$\text{A}^2\cdot\text{s}^3\cdot\text{kg}^{-1}\cdot\text{m}^{-2}$
	resistivity	ohm-metre	$\Omega\cdot\text{m}$	$\text{kg}\cdot\text{m}^3\cdot\text{A}^{-2}\cdot\text{s}^{-3}$
conductivity	siemens per metre	S/m	$\text{A}^2\cdot\text{s}^3\cdot\text{kg}^{-1}\cdot\text{m}^{-3}$	
CHEMISTRY PHYSICS	molar mass	kilogram per mole	kg/mol	$\text{kg}\cdot\text{mol}^{-1}$
	molar volume	cubic metre per mole	m^3/mol	$\text{m}^3\cdot\text{mol}^{-1}$
	concentration	kilogram per cubic metre	kg/m^3	$\text{kg}\cdot\text{m}^{-3}$
	molar concentration molarity	mole per cubic metre mole per kilogram	mol/m^3 mol/kg	$\text{mol}\cdot\text{m}^{-3}$ $\text{mol}\cdot\text{kg}^{-1}$

Form

Main conversion factors for units of measure

Units	Conversion factor	Units	Conversion factor
Length (conversion in metres)			
ångström (Å)	1.10 ⁻¹⁰	mile	1.609344.10 ³
light year	9.46073.10 ¹⁵	nautical mile	1.852.10 ³
fermi (fm)	1.10 ⁻¹⁵	pica	4.2175.10 ³
foot (ft)	3.048.10 ⁻¹	point [US]	3.515.10 ⁻⁴
inch (in)	2.54.10 ⁻²	rod	5.0292.10 ⁰
micron (μ)	1.10 ⁻⁶	sigma (σ)	1.10 ⁻¹²
mil	2.54.10 ⁻⁵	yard (yd)	9.144.10 ⁻¹
Surface area (conversion in metres)			
centiare (ca)	1.10 ⁰	circular mil	5.067075.10 ⁻¹⁰
are (a)	1.10 ²	rood	1.01171.10 ³
hectare (ha)	1.10 ⁴	acre	4.04686.10 ³
Volume (conversion in cubic metres)			
barrel [US]	1.58987.10 ⁻¹	gill [UK]	1.42065.10 ⁻⁴
board foot	2.36.10 ⁻³	gill [US] (gi)	1.18294.10 ⁻⁴
bushel [UK]	3.63687.10 ⁻²	liquid pint [US] (liq pt)	4.73176.10 ⁻⁴
bushel [US] (bu)	3.52391.10 ⁻²	liquid quart [US] (liq qt)	9.46352.10 ⁻⁴
dry barrel [US] (bbl)	1.15627.10 ⁻¹	litre (l)	1.10 ⁻³
dry pint [US] (dry pt)	5.50610.10 ⁻⁴	minim [UK] (min)	5.91939.10 ⁻⁸
dry quart [US] (dry qt)	1.10122.10 ⁻³	minim [US] (min)	6.16115.10 ⁻⁸
fluid ounce [UK] (fl oz)	2.84130.10 ⁻⁵	peck [UK]	9.0922.10 ⁻³
fluid ounce [US] (fl oz)	2.95735.10 ⁻⁵	peck [US]	8.809768.10 ⁻³
gallon [UK] (gal)	4.54609.10 ⁻³	quart [UK] (qt)	1.13652.10 ⁻³
gallon [US] (gal)	3.78541.10 ⁻³		
Planar angle (conversion in radians)			
degree (°)	1.745329.10 ⁻²	minute (')	2.908882.10 ⁻⁴
grade (gr)	1.570796.10 ⁻²	second (")	4.848137.10 ⁻⁶
Time (conversion in seconds)			
hour (h)	3.6.10 ³	minute (min)	6.10 ¹
day (d)	8.64.10 ⁴		
Mass (conversion in kilogrammes)			
cental	4.53592.10 ¹	ton (ton)	1.016047.10 ³
long ton [US]	1.016047.10 ³	tonne (t)	1.10 ³
ounce (oz)	2.834952.10 ⁻²	troy ounce	3.11035.10 ⁻²
pound (lb)	4.535924.10 ⁻¹	troy pound	3.73242.10 ⁻¹
quintal (q)	1.10 ²	atomic mass (u)	1.66054.10 ⁻²⁷
short ton (sh tn)	9.07185.10 ²		
Speed (conversion in metres per second)			
knot	5.14444.10 ⁻⁴		
Force (conversion in Newtons)			
dyne (dyn)	1.10 ⁻⁵	pound-force (lbf)	4.44822.10 ⁰
kilogram-force (kgf)	9.80665.10 ⁰	poundal (pdl)	1.38255.10 ⁻¹
pond (p)	9.80665.10 ⁻³		
Energy transferred, work (conversion in joules)			
british thermal unit (Btu)	1.055056.10 ³	kilogramme (kgm)	9.80665.10 ⁰
calorie I.T. (cal I.T.)	4.1868.10 ⁰	therm	1.055056.10 ⁸
calorie 15°C (cal 15)	4.1855.10 ⁰	thermie (th)	4.1855.10 ⁶
electronvolt (eV)	1.60218.10 ⁻¹⁹	thermochemical calorie (calth)	4.1840.10 ⁰
frigorie (fg)	-4.1855.10 ³	watthour (Wh)	3.6.10 ³
Power (conversion in watts)			
horsepower (hp)	7.35499.10 ²	var (var)	1.10 ⁰
horsepower [UK] (hp)	7.4570.10 ²		
Stress and pressure (conversion in Pascals)			
normal atmosphere (atm)	1.01325.10 ⁵	inch of mercury (inHg)	3.38639.10 ³
technical atmosphere (at)	9.80665.10 ⁴	millimetre of water (mmH ₂ O)	9.80665.10 ⁰
bar (bar)	1.10 ⁵	millimetre of mercury (mmHg)	1.333224.10 ²
foot of water (ftH ₂ O)	2.98907.10 ³	pound-force per square inch (psi)	6.894757.10 ³
inch of water (inH ₂ O)	2.49089.10 ²	torr (Torr)	1.333224.10 ²
Magnetomotive force (conversion in amperes)			
gilbert (Gb)	7.9577.10 ⁻¹		
Quantity of electricity, electric charge (conversion in coulombs)			
ampere-hour (Ah)	3.6.10 ³	franklin (Fr)	3.33564.10 ⁻¹⁰
faraday (F)	9.64870.10 ⁴		
Radioactivity (conversion in bequerels)			
curie (Ci)	03/07/2010 ¹⁰		
Exposure (conversion in coulombs per kilogramme)			
röntgen (R)	2.58 x 10 ⁴		

Temperature conversion factors

Tc: temperature in degrees Celsius
Tk: temperature in degrees Kelvin
Tf: temperature in degrees Fahrenheit

$$T_c = T_k - 273.15$$

$$T_c = 5/9 * (T_f - 32)$$

$$T_f = 1.8 * T_k - 459.67$$

$$T_f = 9/5 * T_c + 32$$

Table of correspondences between American (AWG) and metric (mm²) cross-sections

AWG: American Wire Gauge. MCM: thousands of circular mils

Cross-sections			Diameter	
AWG	MCM	mm ²	mm	inch
-	750	380	-	-
-	700	355	-	-
-	600	304	-	-
-	500	253	-	-
-	400	203	-	-
-	350	177	-	-
-	300	152	-	-
-	250	127	-	-
4/0	212	107	11.7	0.4600
3/0	168	85.0	10.4	0.4096
2/0	133	67.5	9.27	0.3648
1/0	105	53.4	8.25	0.3249
1	83.7	42.4	7.35	0.2893
2	66.4	33.6	6.54	0.2576
3	52.6	26.7	5.83	0.2294
4	41.7	21.2	5.19	0.2043
5	33.1	16.8	4.62	0.1819
6	26.2	13.3	4.11	0.1620
7	20.8	10.6	3.67	0.1443
8	16.5	8.35	3.26	0.1285
9	13.1	6.62	2.91	0.1144
10	10.4	5.27	2.59	0.1019
11	8.23	4.15	2.30	0.0907
12	6.53	3.31	2.05	0.0808
13	5.18	2.63	1.83	0.0720
14	4.11	2.08	1.63	0.0641
15	3.26	1.65	1.45	0.0571
16	2.58	1.31	1.29	0.0508
17	2.05	1.04	1.15	0.04526
18	1.62	0.823	1.024	0.4030
19	1.29	0.653	0.912	0.03589
20	1.02	0.512	0.812	0.03196
21	0.810	0.412	0.723	0.02846
22	0.642	0.325	0.644	0.02535
23	0.509	0.259	0.573	0.02257
24	0.404	0.205	0.511	0.02010
25	0.320	0.163	0.455	0.01790
26	0.254	0.128	0.405	0.01594
27	0.201	0.102	0.361	0.01420
28	0.160	0.0804	0.321	0.01264
29	0.126	0.0646	0.286	0.01126
30	0.100	0.0503	0.255	0.01003
31	0.080	0.0400	0.227	0.00893
32	0.063	0.0320	0.202	0.00795
33	0.050	0.0252	0.180	0.00708
34	0.039	0.0200	0.160	0.00630
35	0.031	0.0161	0.143	0.00561
36	0.025	0.0123	0.127	0.00500
37	0.019	0.0100	0.113	0.00445
38	0.015	0.00795	0.101	0.00397
39	0.012	0.00632	0.0897	0.00353
40	0.0096	0.00490	0.0789	0.00310

Other conversion factors metric system / Anglo-Saxon system

millimetres	x	0.03937	=	inches
millimetres	x	39.37	=	mils
metres	x	39.37	=	inches
metres	x	3.280	=	feet
inches	x	25.40	=	millimetres
feet	x	0.3048	=	metres
mils	x	0.0254	=	millimetres
kilograms	x	2.205	=	pounds
pounds	x	0.4536	=	kilograms
Ω / km	x	0.3048	=	Ω / 1000 feet
Ω / 1000 feet	x	3.281	=	Ω / km
pounds / 1000 feet	x	1.488	=	kg / km
square inches	x	645.2	=	square millimetres
square millimetres	x	1.273	=	circular mm
square millimetres	x	1973.5	=	circular mils
square mils	x	1.273	=	circular mils
circular mm	x	1550	=	circular mils
circular mm	x	0.7854	=	square millimetres

www.omerin.com

The information provided in this technical data sheet is indicative and may be modified without prior notice, laying, wiring and electrical conditions and the environment of the cable can not be fully considered in our studies. In no way the company OMERIN shall be held responsible for any incidents in the case of inappropriate uses, particularly in the case of wiring conditions that do not respect the good practice and the standards in force.

For an optimum use of the cables produced by our company, we recommend testing in real conditions. Our sales department is available for a possible provision of samples, and/or for the conditions of a complete study in our laboratories.

® Registered trademark of the OMERIN Group. Drawings and photos are not contractual. Reproduction is prohibited without the prior agreement of OMERIN.

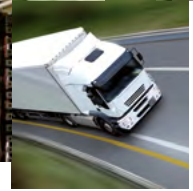
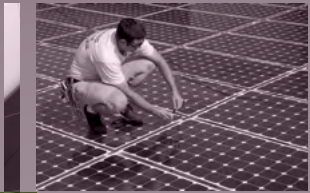



omerin
division principale

omerin
division silisol

Headquarters and division principale
Zone industrielle - 63600 Ambert - France

Tel. +33 **(0)4 73 82 50 00**

Fax +33 (0)4 73 82 50 10

e-mail: omerin@omerin.com

division silisol

B.P. 87 - 11, allée du Couchant Z.I. du Devey
42010 Saint-Etienne Cedex 2 - France

Tel. +33 **(0)4 77 81 36 00**

Fax +33 (0)4 77 81 37 00

e-mail: silisol@omerin.com

www.omerin.com