

**FLEXIBLE HEATING CABLES AND ELEMENTS  
TEMPERATURE MAINTENANCE SYSTEMS**

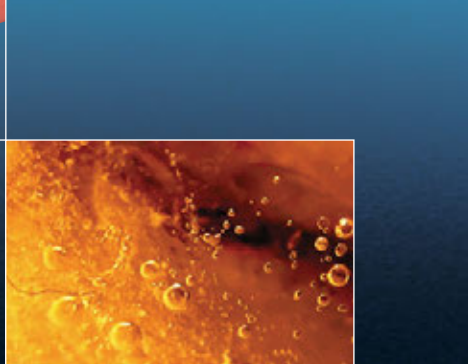

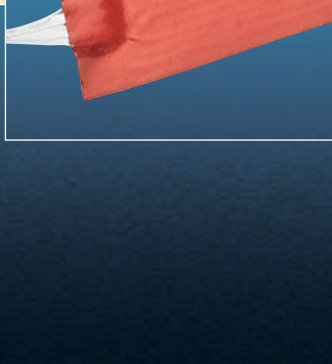
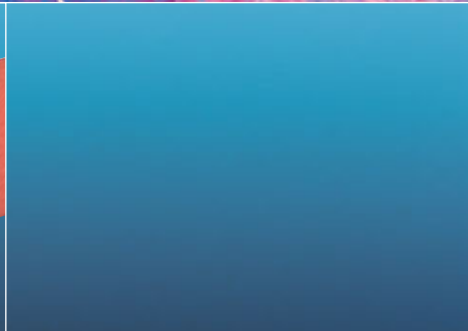
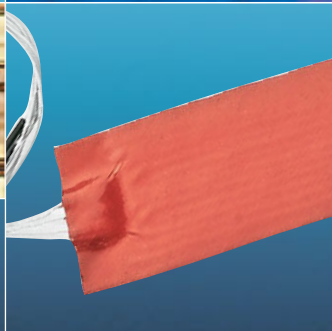
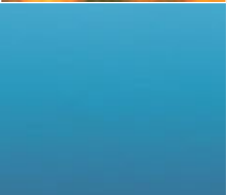
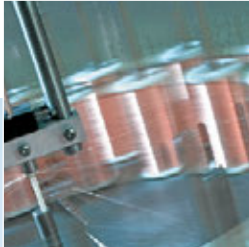

For more than 50 years, FLEXELEC has specialized in the design and production of flexible heating elements for all kinds of temperature maintenance.

The flexible heating elements designed by FLEXELEC owe their efficiency to three main characteristics:

- They can physically adapt to the most complex shapes for optimal energy and heat efficiency.
- They are easy to fit, which means that they can be used quickly to equip installations in which space is at a premium.
- In most situations their operating costs, in relation to the investment involved, make them the most economical option. This is due to the fact that they are made to measure.

As a back-up to its production facility, FLEXELEC provides you with attentive and reactive staff who will assist you in your projects from start to finish. From design stage to the production of prototypes, we help you find the best solutions from both the technical and economic standpoints.

Our skills have been built up through constant product development. This means that today we can provide our customers with innovative solutions for a wide range of applications.

The refrigeration, building, transport, petrochemical and aeronautical industries are just some of the sectors to benefit from our know-how.

Choose Flexelec, and you'll soon see that you are at the focus of our attention.





### AT YOUR SERVICE

Every day our engineering and technical staff work on developing new versions of our products to meet with the most demanding needs. Our ability to understand and adapt to the problems you are confronted with means that our product ranges are constantly being renewed and enriched in the quest for relevant and long-lasting solutions.

### COMMITTED to INNOVATION and QUALITY

FLEXELEC's range of flexible heating elements is manufactured in accordance with quality requirements, not only from the technical standpoint, but also in the way in which our different departments work closely with each other and with our clients.

FLEXELEC has held ISO 9001 certification since 1994 and is proud to add every year to the list of countries in which its products are certified. This is just reward for our active policy and everyone's involvement.

The thermal, electrical, chemical and mechanical characteristics of our products are designed, validated and checked in our laboratory throughout the manufacturing process and then monitored during the years they are in production for optimum safety and traceability.



• teamwork



• customer service



• innovation

• quality





### KNOW-HOW

Our production facilities, our expertise at all manufacturing stages and our in-depth market knowledge mean that we can offer a full range to meet our customers' specific requirements.

Via our website you can learn more about what we have to offer, download document updates in real time or contact us for more information.

[www.flexelec.com](http://www.flexelec.com)



Choose FLEXELEC, and you'll soon see that you are the focus of our attentions.

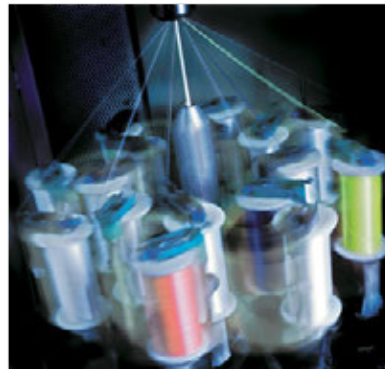

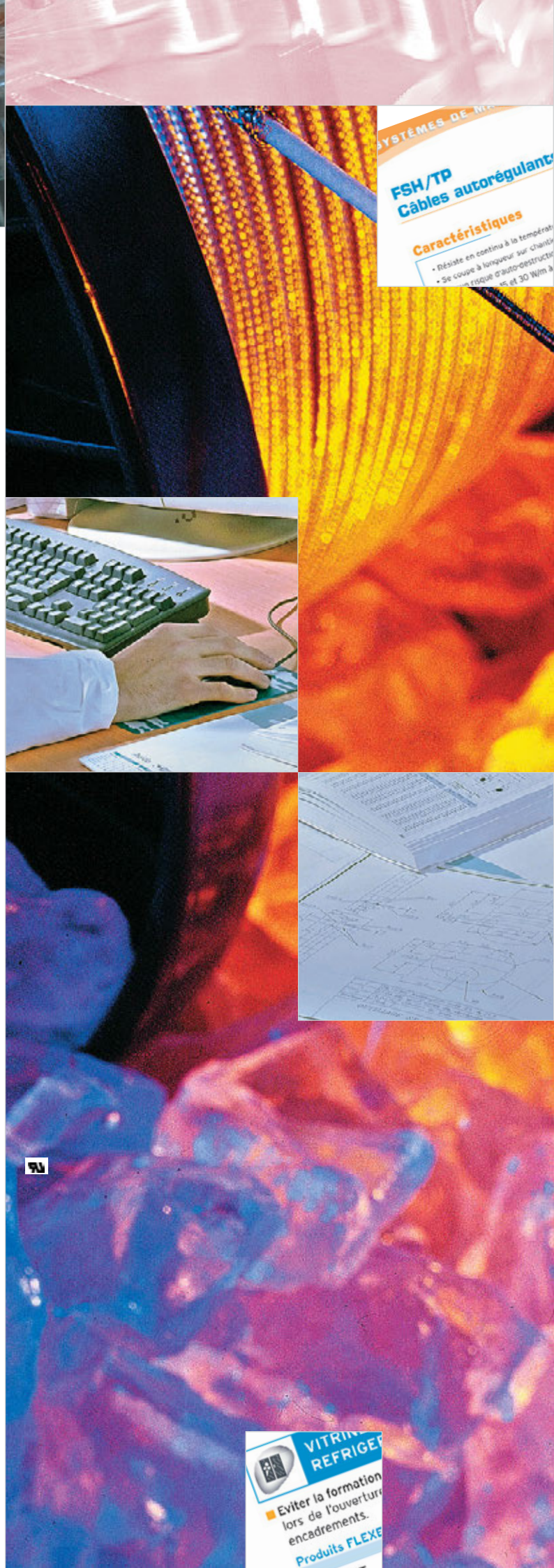

SYSTEMES DE REFRIGERATION  
**FSH/TP**  
**Câbles autorégulants**  
**Caractéristiques**  
 • Résiste en continu à la température de service  
 • Se coupe à longueur sur chantier sans risque d'autodestruction  
 • Puissance nominale de 30 W/m



## A REFERENCE GUIDE

Our catalogue is available on request in several languages and is up-dated on our website. It is intended to provide help with solving your technical issues. You'll find our complete range of cables and flexible heating elements for temperature maintenance systems.

After the contents page, a guide organised by type of application will help you find your way around the catalogue and identify the products you're interested in.

The body of the catalogue presents the technical specifications for each product, including the following essential aspects:

- the main application
- an illustration of the product and the way it is built
- the characteristics and options available as standard
- the main ways in which the product can be used
- highlights of relevant certifications or standards
- any accessories or related technical advice

In the final part of the catalogue, glossaries and segmented questionnaires will help you take the first steps towards choosing the product which corresponds to your needs, and to find the answers to a number of technical questions for yourselves.

**VITRINE REFRIGEREE**  
 ■ Eviter la formation de condensation lors de l'ouverture des encadrements.  
 Produits FLEXE

## Icons used

### REFRIGERATION



windows, cabinets and wine storage units



Refrigerating compressors



Cold rooms doors



Refrigerating units and air conditioning



Evaporators



Heat pumps



Cold room floors

### BUILDING INDUSTRY



Cold water supply



Gutters and roofing



Hot water supply



Inside / outside flooring



Tunnels and pits



Access ramps



Fire networks and safety showers



Stadiums



Roads and circuits



Skating rinks



Heliports

### INDUSTRY



Petrochemical



Plastic and composite materials



Chemical



Adhesives



Agro-food



Electric motors



Military



Household electrical



Aeronautics



Medical, pharmaceutical and cosmetics

### TRANSPORT



Railway switches



Metros



Trains

### MISCELLANEOUS APPLICATIONS



Aquariums and terrariums



Aerials



Special machines and instrumentation



Cash dispensers



Laboratories



Wind generators



Drinking troughs



Vacuum pumps



Printing industry



Batteries



Weather forecasting



Billiard tables



Sports equipment



Horticulture

### BRAND NAMES USED

All the brand names given below are registered trademarks of FLEXELEC, Omerin group:

**FLEXELEC®** : COMPANY NAME AND GENERAL TRADEMARK OF ALL PRODUCTS MADE BY FLEXELEC SAS.

**FLEXCORD®** : HEATING CORDS

**FLEXUNIT®** : HEATING CABLES

**FLEXDRAIN®** : DRAIN-LINE CABLES

**FLEXTAPE®** : HEATING TAPES

**STOPGEL®** : READY-TO-USE CABLES

**ANTIFREEZE®** : READY-TO-USE CABLES

**FLEXTRACE®** : ELECTRIC HEAT TRACING CABLES

**FLEXFLOOR®** : UNDERFLOOR HEATING

**FLEXBELT®** : HEATING BELTS

**FLEXMAT®** : HEATING MATS

**FLEXPLATE®** : HEATING PLATES

**FLEXDRUM®** : DRUM HEATERS

**FLEXKIT®** : ACCESSORIES



All brands, trade names, photos and illustrations in this catalogue are the property of FLEXELEC SAS and the Omerin group. All rights reserved, in keeping with industrial property laws. Any unauthorised use will lead to prosecution.



# WORLDWIDE

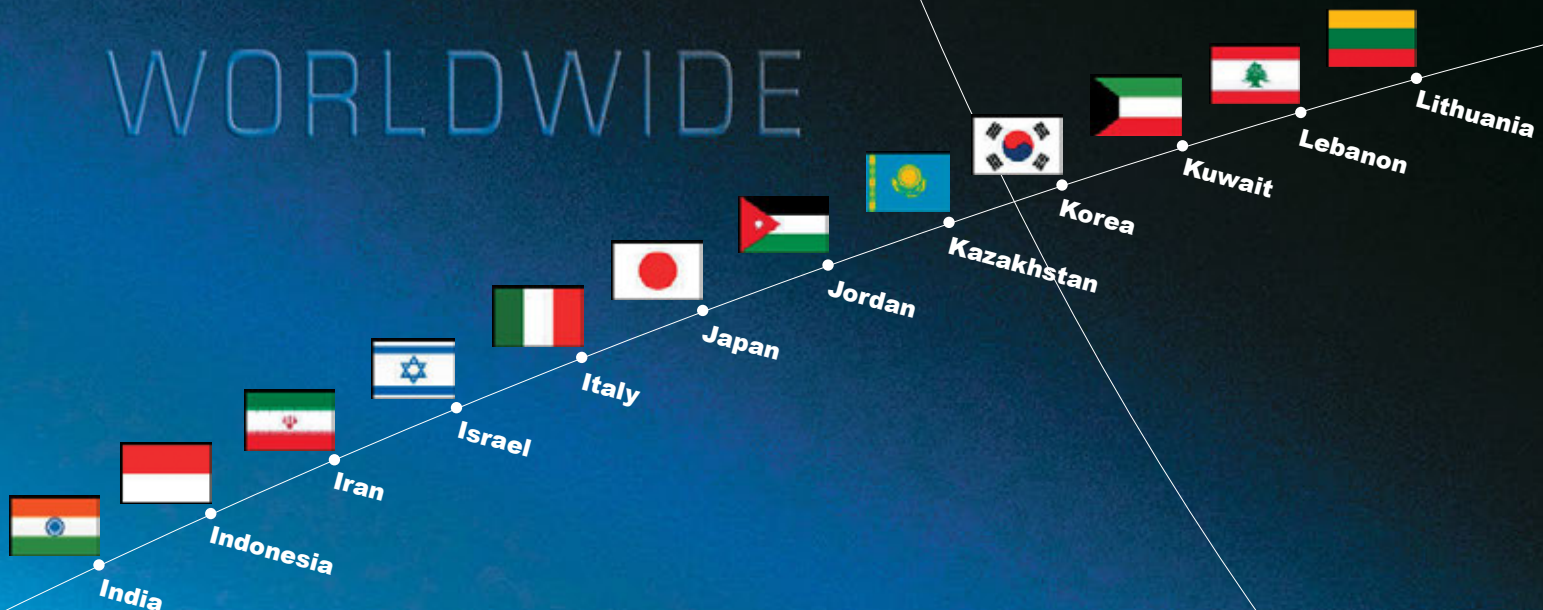

FLEXELEC operates on an international scale, via a huge network of agents, distributors and fitters.

Its know-how is recognised in over 80 countries.

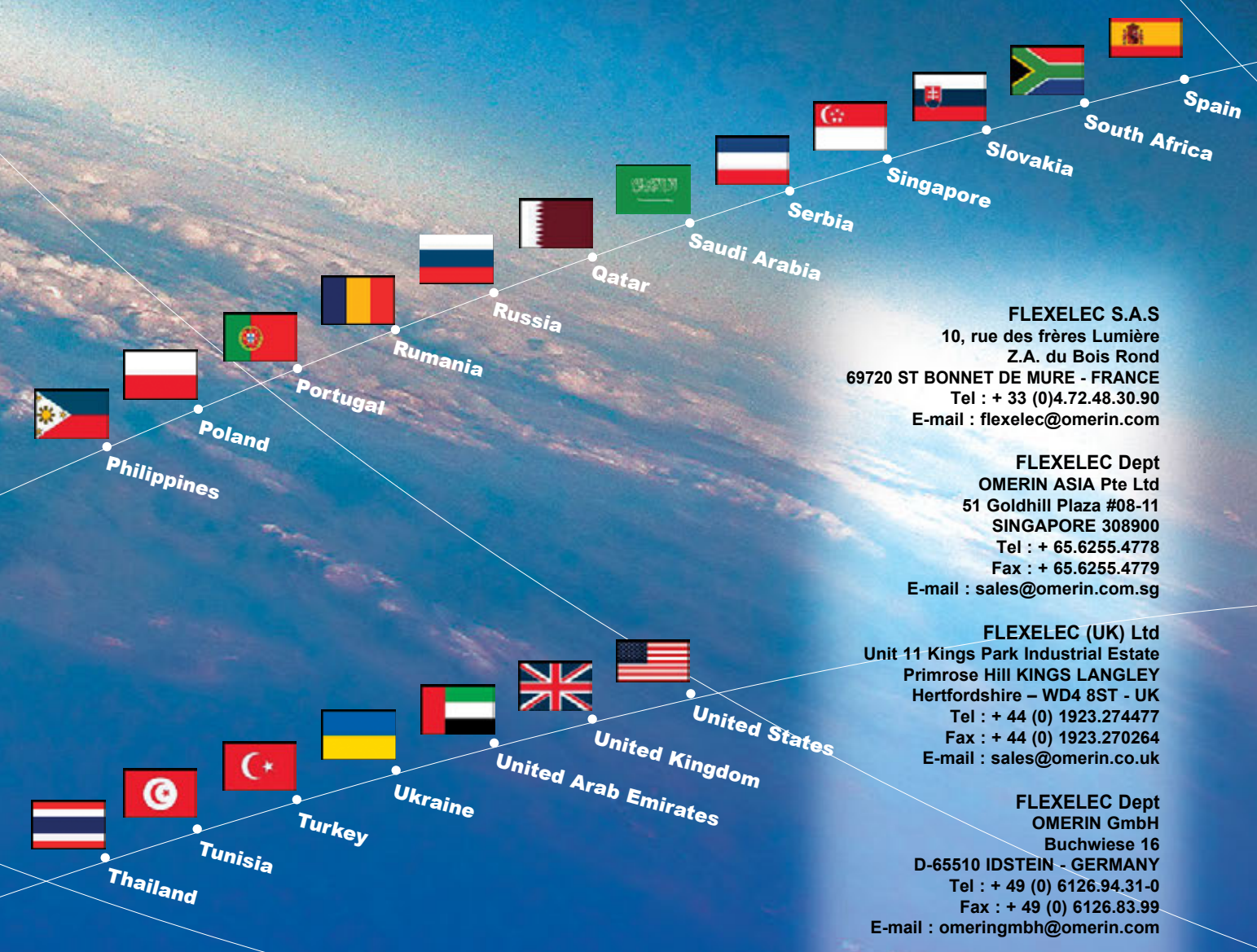

**FLEXELEC S.A.S**  
10, rue des frères Lumière  
Z.A. du Bois Rond  
69720 ST BONNET DE MURE - FRANCE  
Tel : + 33 (0)4.72.48.30.90  
E-mail : flexelec@omerin.com

**FLEXELEC Dept**  
OMERIN ASIA Pte Ltd  
51 Goldhill Plaza #08-11  
SINGAPORE 308900  
Tel : + 65.6255.4778  
Fax : + 65.6255.4779  
E-mail : sales@omerin.com.sg

**FLEXELEC (UK) Ltd**  
Unit 11 Kings Park Industrial Estate  
Primrose Hill KINGS LANGLEY  
Hertfordshire – WD4 8ST - UK  
Tel : + 44 (0) 1923.274477  
Fax : + 44 (0) 1923.270264  
E-mail : sales@omerin.co.uk

**FLEXELEC Dept**  
OMERIN GmbH  
Buchwiese 16  
D-65510 IDSTEIN - GERMANY  
Tel : + 49 (0) 6126.94.31-0  
Fax : + 49 (0) 6126.83.99  
E-mail : omeringmbh@omerin.com





# CONTENTS

<b>GUIDE BY TYPE OF APPLICATION</b>	<b>10</b>
REFRIGERATION	10
BUILDING INDUSTRY	12
INDUSTRY	14
TRANSPORT	16
MISCELLANEOUS APPLICATIONS	18

<b>FLEXCORD®</b>	<b>HEATING CORDS</b>		<b>21</b>
C1P - C1P/T - C1P/I	PVC INSULATED CORDS		22
C1S - C1S/T - C1S/I	SILICON ELASTOMER INSULATED CORDS		23
C1F - C1F/T - C1F/I	FLUOROPOLYMER INSULATED CORDS		24

<b>FLEXUNIT®</b>	<b>HEATING CABLES</b>		<b>25</b>
CP - CP/T - CP/TW - CP/I - CP/IW	PVC INSULATED CABLES		26
CS - CS/T - CS/TW - CS/I - CS/IW	SILICON ELASTOMER INSULATED CABLES		27
CP1	TERMINATED PVC INSULATED CABLES		28
CS1	TERMINATED SILICON ELASTOMER INSULATED CABLES		29
CS2 - CS2/T - CS2/TW - CS2/I - CS2/IW	SILICON ELASTOMER INSULATED CABLES		30
CV/I	GLASS FIBRE INSULATED CABLES		31
TUY	FLEXIBLE HEATED HOSES		32

<b>FLEXDRAIN®</b>	<b>DRAIN-LINE CABLES</b>		<b>33</b>
CSC - CSC/T - CSC/I - CSC/TS	SILICON ELASTOMER INSULATED DRAIN-LINE CABLES		34
CSC2	SILICON ELASTOMER INSULATED DRAIN-LINE CABLES		35
CSC2K	SILICON ELASTOMER INSULATED DRAIN-LINE CABLES WITH INTEGRATED THERMOSTAT		36
CSC2M	SILICON ELASTOMER INSULATED DRAIN-LINE CABLES MICRO SIZE FOR REFRIGERATION		37

<b>FLEXTAPE®</b>	<b>HEATING TAPES</b>		<b>38</b>
RP - RP/T - RP/I	PVC INSULATED TAPES		39
RS - RS/T - RS/I	SILICON ELASTOMER INSULATED TAPES		40
RSV	ANTI-CONDENSATION TAPES FOR ELECTRIC MOTORS		41
RV/I	GLASS FIBRE INSULATED TAPES		42
RVR	SILICA FIBRE INSULATED TAPES		43

<b>STOPGEL® - ANTIFREEZE®</b>			<b>44</b>
STOPGEL - ANTIFREEZE	READY-TO-USE CABLES		45

<b>FLEXTRACE®</b>	<b>ELECTRIC HEAT-TRACING CABLES</b>		<b>46</b>
FSH2/TP	SELF-REGULATING CABLES FOR TEMPERATURE MAINTENANCE		47
FSJ - FSJ/T - FSJ/TP	SELF-REGULATING CABLES		48
FSO - FSO/T - FSO/TP	SELF-REGULATING CABLES		49
FST - FST/T - FST/I - FST/TP - FST/TF	SELF-REGULATING CABLES		50
FSX - FSX/T - FSX/I - FSX/TF	SELF-REGULATING CABLES		51
FTC	CONSTANT POWER CABLES FOR GUTTERS		52
FTP - FTP/T - FTP/I - FTP/TP	PVC INSULATED CONSTANT POWER CABLES		53
FTP0 - FTP0/T - FTP0/TP	PVC INSULATED CONSTANT POWER CABLES FOR REFRIGERATION		54

FTSH - FTSH/T - FTSH/I - FTSH/TS - FTSH/TF	SILICON ELASTOMER INSULATED CONSTANT POWER CABLES	55
FTS0 - FTS0/T - FTS0/TS	SILICON ELASTOMER INSULATED CONSTANT POWER CABLES FOR REFRIGERATION	56
FTSL/TF - FTSL/TS	CONSTANT POWER CABLES WITH SELF-LIMITING EFFECT	57
FTSM - FTSM/T	SILICON ELASTOMER INSULATED CONSTANT POWER CABLES MICRO SIZE FOR REFRIGERATION	58
FTS3/IS - FTS3/IF	HIGH POWER CONSTANT POWER CABLES	59
FTTH - FTTH/T - FTTH/I - FTTH/TF - FTTH/IS	FLUOROPOLYMER INSULATED CONSTANT POWER CABLES	60
FTX1	POLYETHYLEN INSULATED CONSTANT POWER CABLES	61
C1FS/I - C2FS/I - C3FS/I	LONG CABLES AND TAPES	62
C4FS/IS	LONG CABLES AND TAPES	63
SR - SRHT	LONG CABLES AND TAPES	64-65
ZFE/CGE/ATEX - ZFA/CGA/ATEX	ATEX FLUOROPOLYMER INSULATED CONSTANT POWER CABLES	66

## **FLEXFLOOR®**

### **UNDERFLOOR HEATING CABLES**

KY - KYCY	CABLES FOR UNDERFLOOR HEATING	68
KYCYR	SERIES CABLES FOR UNDERFLOOR HEATING	69
KYX	SERIES CABLES FOR ROAD HEATING	70

## **FLEXBELT®**

### **HEATING BELTS**

FCH	HEATING BELTS FOR REFRIGERATION COMPRESSORS	72
FCHK	HEATING BELTS WITH INTEGRATED THERMOSTAT FOR REFRIGERATION COMPRESSORS	73

## **FLEXMAT®**

### **HEATING MATS**

A	ALUMINIUM MATS	75
T - TA - TV - TP	SILICON ELASTOMER INSULATED MATS	76-77

## **FLEXPLATE®**

### **HEATING PLATES**

PLA	HEATING PLATES	79
-----	----------------	----

## **FLEXDRUM®**

### **DRUM HEATERS**

TCF - TCF/TV	SILICON ELASTOMER INSULATED DRUM HEATERS	81
--------------	--	----

## **FLEXKIT®**

### **ACCESSORIES**

TERMINATION	CONNECTION KITS	83
MOUNTING	FITTING ACCESSORIES	84
FX/AT2 - FX/AT - FX/ST	THERMOSTATS	85
FX/TM3	ELECTRONIC THERMOSTATS	86
FX/CDM2	HYGROTHERMOSTATS	87
FX/CDM3	HYGROTHERMOSTATS	88
FX/DC1P	POWER MODULATORS	89

## **TECHNICAL GUIDE**

GENERAL INSTALLATION CONDITIONS	90-93
PIPING QUESTIONNAIRES	94
VESSEL - HOPPER QUESTIONNAIRES	95
PRODUCTS QUESTIONNAIRES	96
OPERATING PRINCIPLES	97
TECHNICAL FORMULAE	98-101
GENERAL SALES CONDITIONS	102

## REFRIGERATION



### WINDOWS, DISPLAY CABINETS and WINE STORAGE

- Prevent mist or frost forming when opening glass doors by fitting a heating flex in the frames.

#### FLEXELEC products:

<b>FLEXUNIT</b>	CP - CP/T - CP/TW - CP/I - CP/IW	p 26
	CS - CS/T - CS/TW - CS/I - CS/IW	p 27
	CP1	p 28
	CS1	p 29
	CS2 - CS2/T - CS2/TW	p 30

- Prevent seals from sticking due to freezing in equipment running at below-zero temperatures and enable doors to open and close by fitting a heating element in the frames.

#### FLEXELEC products:

<b>FLEXUNIT</b>	CP - CP/T - CP/TW - CP/I - CP/IW	p 26
	CS - CS/T - CS/TW - CS/I - CS/IW	p 27
	CP1	p 28
	CS1	p 29
	CS2 - CS2/T - CS2/TW	p 30

<b>FLEXTRACE</b>	FTS0 - FTS0/T - FTS0/TS	p 56
	FTSM - FTSM/T	p 58

- Allow water from defrost cycles to flow freely or help it to evaporate by internal or external tracing of piping, collector spouts or trays.

#### FLEXELEC products:

<b>FLEXDRAIN</b>	CSC - CSC/T - CSC/I - CSC/TS	p 34
	CSC2	p 35
	CSC2M	p 37



### COLD ROOM DOORS

- Heat seals to allow doors to open and close by including a heating flex in a groove made in the frame opposite the seal. This stops the door from sticking due to freezing.

#### FLEXELEC products:

<b>FLEXUNIT</b>	CP - CP/T - CP/TW - CP/I - CP/IW	p 26
	CS - CS/T - CS/TW - CS/I - CS/IW	p 27
	CP1	p 28
	CS1	p 29
	CS2 - CS2/T - CS2/TW	p 30

<b>FLEXTRACE</b>	FSJ - FSJ/T - FSJ/TP	p 48
	FTS0 - FTS0/T - FTS0/TS	p 54
	FTSM - FTSM/T	p 56



### EVAPORATORS

- Allow water from defrost cycles to flow: an aluminium heating fabric is laid inside the collector tray. When the outlet pipe is located inside the cold room, a special heating flex is laid inside it.

#### FLEXELEC products:

<b>FLEXDRAIN</b>	CSC - CSC/T - CSC/I	p 34
	CSC2	p 35
	CSC2M	p 37

<b>FLEXMAT</b>	A	p 75
----------------	---	------

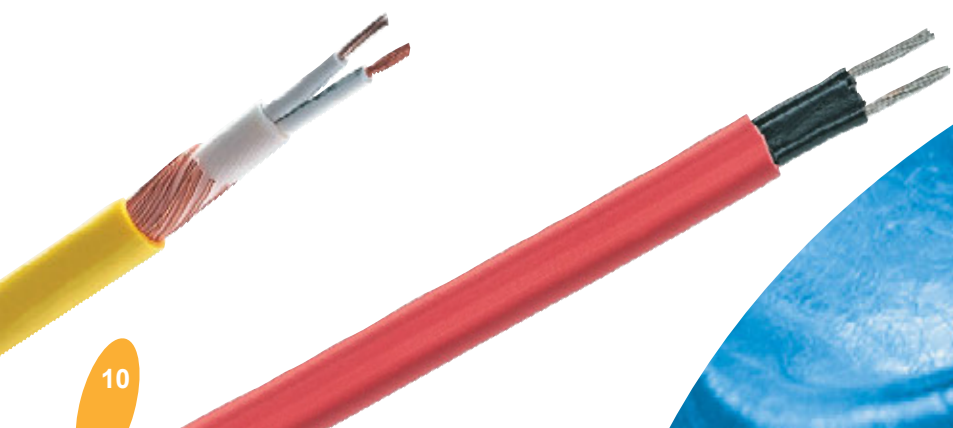
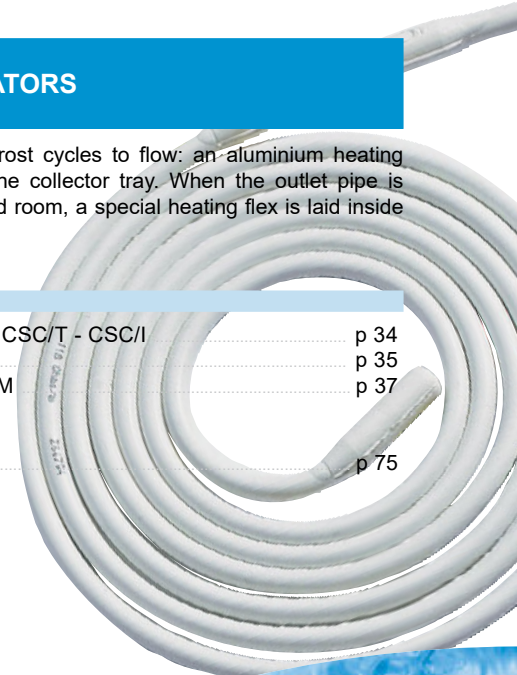

Flexible heating elements are used for many applications in the refrigeration industry, which is a major area of innovation and development for FLEXELEC products. These heating elements are always essential for the equipment to function properly, whether they are fitted in cold rooms, refrigerated vehicles or in supermarkets.



## COLD ROOM FLOORS

- Maintain the temperature of concrete sub-bases by making a thermal barrier under the insulation. This prevents condensation which, as it expands due to freezing, could damage the floor of the building.
- Prevent ice from forming on the surface of the floor by laying the heating cable in the top concrete slab above the insulation, at the entrances and exits of freezing tunnels, unloading docks, etc...

### FLEXELEC products:

<b>FLEXFLOOR</b>	KYCY	p 68
	KYCYR	p 69



## REFRIGERATING COMPRESSOR

- Separate the coolant from the lubricating oil by fitting a heating collar around the compressor: this will protect against the absorption phenomenon caused by the low temperatures.

### FLEXELEC products:

<b>FLEXBELT</b>	FCH	p 72
	FCHK	p 73
<b>FLEXMAT</b>	A	p 75



## REFRIGERATING UNITS and AIR CONDITIONING

- Protect fluids circulating in exchangers, pumps, collectors, tanks and piping from freezing, to guard against malfunctioning and flow interference.

### FLEXELEC products:

<b>FLEXDRAIN</b>	CSC2	p 35
	CSC2K	p 36
	CSC2M	p 37
<b>FLEXTRACE</b>	FSJ - FSJ/T - FSJ/TP	p 48
	FTP0 - FTP0/T - FTP0/TP	p 54
	FTS0 - FTS0/T - FTS0/TS	p 56
	FTSM - FTSM/T	p 58
<b>FLEXBELT</b>	FCH	p 72
	FCHK	p 73
<b>FLEXMAT</b>	A	p 75



## HEAT PUMPS

- Prevent ice from forming and assist evaporation by including a heating cable in the bottom of the tank or along drain pipes.

### FLEXELEC products:

<b>FLEXDRAIN</b>	CSC2	p 35
	CSC2K	p 36
	CSC2M	p 37
<b>FLEXTRACE</b>	FSJ - FSJ/T - FSJ/TP	p 48
	FTP0 - FTP0/T - FTP0/TP	p 54
	FTS0 - FTS0/T - FTS0/TS	p 56
<b>FLEXMAT</b>	A	p 75

# BUILDING INDUSTRY



## COLD WATER SUPPLY

- Protect the water supply in housing, garages, car parks, gardens or on the roofs of buildings whose pipes need to be protected against freezing in winter. As heat insulation has made great progress, piping now runs through colder and colder areas. Not only do they need to be lagged, but also heat losses must be offset to prevent freezing.

### FLEXELEC products:

<b>FLEXTAPE</b>	RP - RP/T - RP/I	p 39
	RS - RS/T - RS/I	p 40
<b>STOPGEL - ANTIFREEZE</b>		p 45
<b>FLEXTRACE</b>	FSO - FSO/T - FSO/TP	p 49
	FST - FST/T - FST/I - FST/TP - FST/TF	p 50
	FTP - FTP/T - FTP/I - FTP/TP	p 53
	FTSH - FTSH/T - FTSH/I - FTSH/TS - FTSH/TF	p 55
	FTX1	p 61



## HOT WATER SUPPLY

- Reduce water consumption when the tap-off point is distant from the boiler. In hotels, schools, leisure centers, offices and shopping centers, major savings can be made by not having to waste water while waiting until it runs hot. To achieve this, a heating cable is simply run along the piping under the lagging. This system can also be used in certain cases for periodic destruction of legionnaires' disease bacteria.

### FLEXELEC products:

<b>FLEXTRACE</b>	FSH2/TP	p 47
	FTP - FTP/T - FTP/I - FTP/TP	p 53
	FTSH - FTSH/T - FTSH/I - FTSH/TS - FTSH/TF	p 55



## TUNNELS AND PITS

- As in the Channel Tunnel, flexible heating elements are used to keep fire mains and water mains up to temperature over very large distances.

### FLEXELEC products:

<b>FLEXTRACE</b>	C1FS/I - C2FS/I - R3FS/I	p 62
	C4FS/IS	p 63
	SR - SRHT	p 64-65



## FIRE NETWORKS and SAFETY SHOWERS

- Make sure that water is supplied to fire hydrants and safety showers. Whatever the climate, it is vital that emergency services have operational equipment available, or automatic systems come into action as quickly and as efficiently as possible.

### FLEXELEC products:

<b>FLEXTAPE</b>	RP - RP/T - RP/I	p 39
	RS - RS/T - RS/I	p 40
<b>FLEXTRACE</b>	FSO - FSO/T - FSO/TP	p 49
	FST - FST/T - FST/I - FST/TP - FST/TF	p 50
	FTP - FTP/T - FTP/I - FTP/TP	p 53
	FTSH - FTSH/T - FTSH/I - FTSH/TS - FTSH/TF	p 55



## ROADS and CIRCUITS

- Prevent accidents on steep gradients of urban road networks, or enable vehicle testing circuits to be used for longer in the year by removing snow and stopping black ice from forming. Specially developed heating cables can be incorporated directly into the road surface while it is being laid.

### FLEXELEC products:

<b>FLEXFLOOR</b>	KYX	p 70
------------------	-----	------

- Fluidify bitumen and binder materials during road works by high temperature heat-tracing of piping, pumps and underpasses.

### FLEXELEC products:

<b>FLEXTRACE</b>	FTTH - FTTH/T - FTTH/I - FTTH/TF	p 60
	FTSL/TF - FTSL/TS	p 57



## HELISTATIONS

- Make helicopter landing safer and make it easier for emergency medical teams to arrive on the scene by fitting heating cables that activate in the event of harsh weather conditions. Helistations or walkways are generally made of concrete or metal.

### FLEXELEC products:

<b>FLEXFLOOR</b>	KYCY	p 68
	KYCYR	p 69

People working in the building and public works sectors have to handle a great many situations in which it is essential to maintain constant temperatures. Flexible heating elements are needed for this, either during building work or afterwards when the buildings are being used.



## GUTTERS and ROOFING

- Stop snow and ice from building up in gutters, roof valleys, drainpipes or roofs. If these drainage systems are out of action, water could overflow and damage facades. Similarly, icicles that have formed along roof edges can be dangerous for passers-by, and snow building up on roofs with a small gradient can weaken the structure of the building.

### FLEXELEC products:

<b>FLEXTRACE</b> FTC	p 52
FST/TP/30	p 50
<b>FLEXFLOOR</b> KYCY	p 68
KYCYR	p 69



## STADIUMS

- Make sure that sports events or training sessions take place in the best possible conditions. By laying the heating cable under the playing field they can be used whatever the weather conditions. By keeping the grass free of snow as it falls and preventing it from freezing it will last significantly longer.

### FLEXELEC products:

<b>FLEXFLOOR</b> KYX	p 70
----------------------	------



## INSIDE / OUTSIDE FLOORING

- Make use of the accumulating capacity of concrete slabs to heat rooms or patios by means of heating cables set into the slab. Underfloor heating is very comfortable as the temperature is the same throughout the room with fewer fluctuations. The system also takes up less space than conventional heating systems.

### FLEXELEC products:

<b>FLEXFLOOR</b> KYCY	p 68
KYCYR	p 69



## SKATING RINKS

- Keep floor slabs at constant temperature by forming a thermal barrier under the insulation to prevent condensation from forming which, as it expands when freezing, could damage the floor of the building.

### FLEXELEC products:

<b>FLEXFLOOR</b> KYCY	p 68
KYCYR	p 69

- Prevent ice removed during defrost cycles from building up and help it to run away by including a heating cable in the bottom of tanks, along gutters and drainpipes, etc...

### FLEXELEC products:

<b>FLEXTRACE</b> FTC	p 52
FST/TP/30	p 50



## ACCESS RAMPS

- Keep accesses to shopping centers, hospitals, car park ramps, pedestrian crossings, walkways, bridges or loading dock platforms free from snow and black ice by using heating cables set into the concrete slab or asphalt.

### FLEXELEC products:

<b>FLEXFLOOR</b> KYCY	p 68
KYCYR	p 69
KYX	p 70

# INDUSTRY



## PETROCHEMICAL

- Keep process temperatures constant, often in extreme conditions on account of the hydrocarbons being transported, or if the environment has been classified as a dangerous zone. The electrical heat tracing has in this case to be ATEX-qualified as explosion-proof, both for the cable and the junction boxes.

The equipment traced can be gas or oil pipelines, conduits, tanks, pumps, etc...

### FLEXELEC products:

<b>FLEXTRACE</b>	F50 - F50/T - F50/TP	p 49
	FST - FST/T - FST/I - FST/TP - FST/TF	p 50
	FSX - FSX/T - FSX/I - FSX/TF	p 51
	FTSH - FTSH/T - FTSH/I - FTSH/TS - FTSH/TF	p 55
	FTSL/TF - FTSL/TS	p 57
	FTTH - FTTH/T - FTTH/I - FTTH/TF	p 59
	C1FS/I - C2FS/I - C3FS/I	p 61
	C4FS/IS	p 63
	SR - SRHT	p 64-65
	ZFE/CGE/ATEX - ZFA/CGA/ATEX	p 66



## CHEMICAL

- Heat or temper vessels and tanks containing corrosive substances by means of electrical heat tracing using heating cables or tapes that are highly resistant to different types of corrosion.

### FLEXELEC products:

<b>FLEXTRACE</b>	F50 - F50/T - F50/TP	p 49
	FST - FST/T - FST/I - FST/TP - FST/TF	p 50
	FSX - FSX/T - FSX/I - FSX/TF	p 51
	FTSH - FTSH/T - FTSH/I - FTSH/TS - FTSH/TF	p 55
	FTSL/TF - FTSL/TS	p 57
	FTTH - FTTH/T - FTTH/I - FTTH/TF	p 60
	C1FS/I - C2FS/I - C3FS/I	p 62
	C4FS/IS	p 63
	SR - SRHT	p 64-65
	ZFE/CGE/ATEX - ZFA/CGA/ATEX	p 66

<b>FLEXDRUM</b>	TCF - TCF/TV	p 81
-----------------	--------------	------



## AGRO-FOOD

- Provide professionals, craftsmen or industrialists with perfectly tempered tools so that they can work with delicate ingredients in ideal conditions. Temperature control is also very important, especially for chocolate, glucose and certain oils which could be damaged by overheating.

### FLEXELEC products:

<b>FLEXUNIT</b>	TUY	p 32
-----------------	-----	------

<b>FLEXTRACE</b>	F50 - F50/T - F50/TP	p 49
	FST - FST/T - FST/I - FST/TP - FST/TF	p 50
	FSX - FSX/T - FSX/I - FSX/TF	p 51
	FTSH - FTSH/T - FTSH/I - FTSH/TS - FTSH/TF	p 55
	FTTH - FTTH/T - FTTH/I - FTTH/TF	p 60

<b>FLEXDRUM</b>	TCF - TCF/TV	p 81
-----------------	--------------	------



## MILITARY

- Protect on-board electronics in ships or planes, simulate heat sources for fine-tuning thermo-guided missiles: for such sensitive applications, customised flexible heating elements are used to attain extreme levels of performance and reliability.

### FLEXELEC products:

<b>FLEXMAT</b>	T - TA - TV - TP	p 76-77
----------------	------------------	---------



## AERONAUTICAL

- Control the manufacturing process for helicopter blades to check material uniformity by placing silicon heating mats provided with temperature probes during in situ repair or maintenance operations.

### FLEXELEC products:

<b>FLEXMAT</b>	T - TA - TV - TP	p 76-77
----------------	------------------	---------

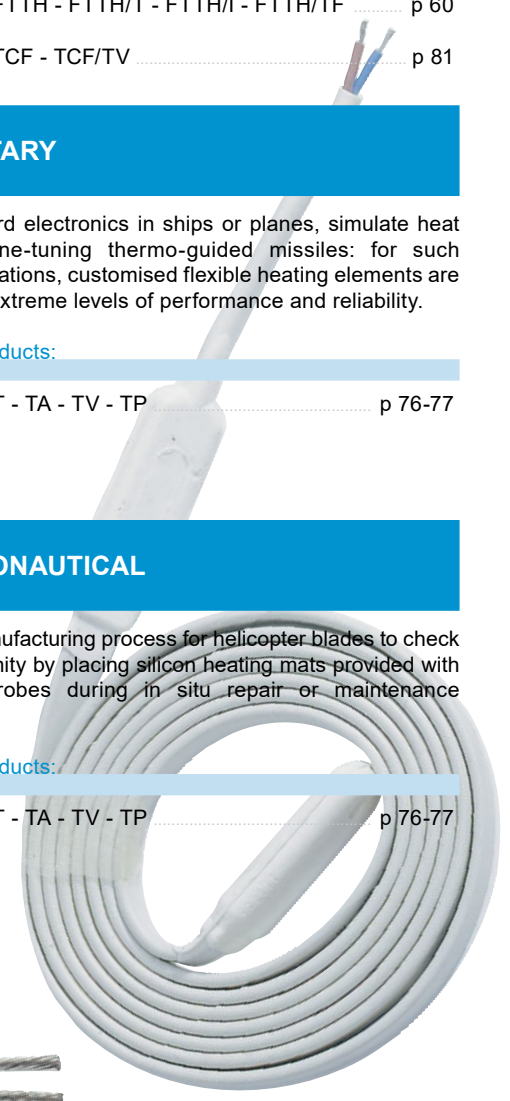

In an industrial environment, temperature control systems are essential for a number of manufacturing processes. FLEXELEC product ranges meet with the most demanding quality, precision and durability criteria.



## PLASTICS and COMPOSITE MATERIALS

- Improve casting and drying during operations involving plastic moulding or resin impregnation of composite materials. Heating by means of flexible elements optimizes output rates and also quality by moulding to the complex shapes of the supports used.

### FLEXELEC products:

<b>FLEXCORD</b>	C1S - C1S/T - C1S/I	p 23
	C1F - C1F/T - C1F/I	p 24
<b>FLEXUNIT</b>	CS - CS/T - CS/TW - CS/I - CS/IW	p 27
	CS2 - CS2/T - CS2/TW	p 30
<b>FLEXMAT</b>	T - TA - TV - TP	p 76-77



## ADHESIVES

- Control the temperature of adhesives, especially on flexible moving parts so that viscosity is always ideal without wasting time or materials when starting cycles. For this, hoses pipes are used to combine temperature and pressure constraints throughout the material transfer process.

### FLEXELEC products:

<b>FLEXUNIT</b>	TUY	p 32
-----------------	-----	------



## ELECTRIC MOTORS

- Prevent short-circuit risks caused by condensation during cooling after using electric motors and occurring when restarting them. The special glass fibre heating tapes are approved for use in ATEX explosive environments.

### FLEXELEC products:

<b>FLEXTAPE</b>	RSV	p 41
-----------------	-----	------



## HOUSEHOLD ELECTRICAL

- Produce a temperature cycle for a yoghurt maker, a towel dryer or, more surprisingly, for a portable footbath. The household electrical sector is a promising one for developing technical solutions using heating cords or cables.

### FLEXELEC products:

<b>FLEXCORD</b>	C1P - C1P/T - C1P/I	p 22
	C1S - C1S/T - C1S/I	p 23
	C1F - C1F/T - C1F/I	p 24
<b>FLEXUNIT</b>	CP - CP/T - CP/TW - CP/I - CP/IW	p 26
	CS - CS/T - CS/TW - CS/I - CS/IW	p 27
	CP1	p 28
	CS1	p 29
	CS2 - CS2/T - CS2/TW	p 30



## MEDICAL, PHARMACEUTICAL AND COSMETICS

- Prepare optimum conditions in which to develop, produce or administer medicines, prostheses or creams by keeping control of molecule conservation temperature indicators and excipient viscosity.

### FLEXELEC products:

<b>FLEXUNIT</b>	CP - CP/T - CP/TW - CP/I - CP/IW	p 26
	CS - CS/T - CS/TW - CS/I - CS/IW	p 27
	CP1	p 28
	CS1	p 29
	CS2 - CS2/T - CS2/TW	p 30
<b>FLEXMAT</b>	T - TA - TV - TP	p 76-77
<b>FLEXDRUM</b>	TCF - TCF/TV	p 81



# TRANSPORT



## RAILWAY SWITCHES

- Prevent snow and ice from building up on railway switches to allow them to operate properly. The switches are heated by means of a heating cable held in place by a composite strip. Guard rails and slides are heated with plates fitted in strings so that the distance between them can be adjusted to focus power at critical points.

This system makes it possible to reduce the installed power for each set of switches. Cables and plates for switches are fully sealed, with a particularly high insulation resistance.

### FLEXELEC products:

<b>FLEXPLATE</b> PLA .....	p 79
<b>FLEXTRACE</b> FTS3/IS - FTS3/IF .....	p 59



## METROS

FLEXELEC has developed a complete range of heating cables and fitting systems especially for heating metro tracks.

The cables are customised for each project. They can be powered at 750V, which makes for very long circuits.

Operating conditions are very severe and require maximum flexibility. The solution chosen must be precisely tailored to meet with this need..

For over 30 years, FLEXELEC has been designing, supplying and fitting systems for number of transport networks in France and abroad. Cities such as Turin relied on these technologies for their new infrastructures for the prestigious 2006 Winter Olympics.

- Prevent ice or frost from forming on the third rail (pick-up rail) which drives the power car. Poor contact can lead to unscheduled stops and safety problems.

### FLEXELEC products:

<b>FLEXTRACE</b> FTS3/IS - FTS3/IF .....	p 59
C1FS/I - C2FS/I - C3FS/I .....	p 62
C4FS/IS .....	p 63
SR - SRHT .....	p 64-65

- Make sure that tyres adhere properly to tracks, especially on overhead sections.

### FLEXELEC products:

<b>FLEXTRACE</b> FTS3/IS - FTS3/IF .....	p 59
C1FS/I - C2FS/I - C3FS/I .....	p 62
C4FS/IS .....	p 63
SR - SRHT .....	p 64-65

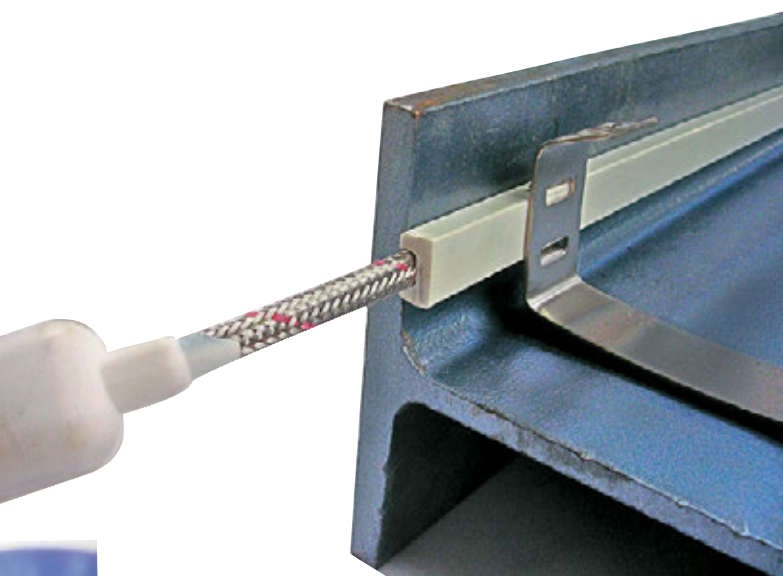

Rail transport is one of FLEXELEC's key areas of expertise. Innovative solutions are proposed for an environment in which reliability and safety are paramount.



## TRAINS

From the power car to the coaches, modern trains need efficient heating systems for several very special applications.

- The driver's hands and feet need to be kept comfortably warm in and around his immediate environment. Heating mats placed on the floor and on the dashboard provide close-up warmth to counter the fact that ambient heating in the locomotive is not enough in the harsh climate of many countries.

### FLEXELEC products:

**FLEXMAT** T - TA - TV - TP ..... p 76-77

- In coach entrance vestibules a build-up of snow and ice is a source of risk for passengers as the floor becomes slippery. Heating cables fitted in the floor eliminate this danger while also improving comfort for those passengers travelling in the vestibule.

### FLEXELEC products:

**FLEXUNIT** CP - CP/T - CP/TW - CP/I - CP/IW ..... p 26  
 CS - CS/T - CS/TW - CS/I - CS/IW ..... p 27  
 CP1 ..... p 28  
 CS1 ..... p 29  
 CS2 - CS2/T - CS2/TW ..... p 30

**FLEXPLATE** PLA ..... p 79

- Under the train, the speed and the outside temperature may cause piping and drinking water or waste water tanks to freeze. This can cause the toilets to seriously malfunction.

### FLEXELEC products:

**FLEXMAT** T - TA - TV - TP ..... p 76-77

- The system that unfolds the pantograph is a sensitive part of the train since it is of prime importance in supplying electric power to it. Silicon fabrics are vulcanised directly to the stainless steel to ensure maximum power transfer.

### FLEXELEC products:

**FLEXMAT** T - TA - TV - TP ..... p 76-77

- The coupling, and the cover plate which protects it, between coaches and locomotives must be accessible and easy to manoeuvre even in winter when freezing must be prevented.

### FLEXELEC products:

**FLEXMAT** T - TA - TV - TP ..... p 76-77

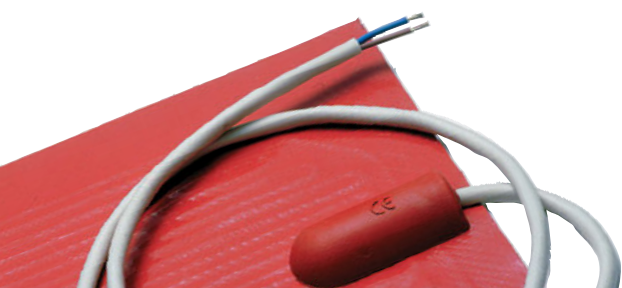

## APPLICATIONS DIVERSES



### AQUARIUMS and TERRARIUMS

- Reproduce climate conditions identical to those of the original environment of the most fragile fish and reptile species. Heating cables provide homogeneity and perfect safety for any type of installation.

#### FLEXELEC products:

<b>FLEXUNIT</b>	CP - CP/T - CP/TW - CP/I - CP/IW	p 26
	CS - CS/T - CS/TW - CS/I - CS/IW	p 27
<b>FLEXDRAIN</b>	CSC - CSC/T - CSC/I - CSC/TS	p 34



### SPECIAL MACHINES and INSTRUMENTATION

- Work on the design of special machines as closely as possible to the desired temperatures, temper the finest and most fragile sensors or acquisition conduits so that they generate as few uncertainties as possible. Heating pipes are used by designers and developers working in these niche markets.

#### FLEXELEC products:

<b>FLEXUNIT</b>	TUY	p 32
<b>FLEXDRAIN</b>	CSC - CSC/T - CSC/I - CSC/TS	p 34
<b>FLEXTAPE</b>	RS - RS/T - RS/I	p 40
<b>FLEXMAT</b>	T - TA - TV - TP	p 76-77
	A	p 75



### LABORATORIES

- Bring gas piping, vacuum pumps or baking analysis stands up to 450°C or 900°C, using the properties of glass fibre and silica fibre flexes and tapes. Prevent condensation at critical points in particle accelerators. State-of-the-art research laboratories are pushing FLEXELEC innovation to ever more high-performance developments.

#### FLEXELEC products:

<b>FLEXUNIT</b>	CV/I	p 31
<b>FLEXTAPE</b>	RS - RS/T - RS/I	p 40
	RV/I	p 42
	RVR	p 43
<b>FLEXMAT</b>	T - TA - TV - TP	p 76-77



### DRINKING TROUGHS

- Supply drinking water to animals, studs and farms, both inside unheated buildings and in fields. Electrical trace heating must be used in conjunction with electrical and mechanical protection to ensure safety for the animals.

#### FLEXELEC products:

<b>FLEXTAPE</b>	RP - RP/T - RP/I	p 39
	RS - RS/T - RS/I	p 40
<b>STOPGEL - ANTIFREEZE</b>		p 45
<b>FLEXTRACE</b>	FSO - FSO/T - FSO/TP	p 49
	FST - FST/T - FST/I - FST/TP - FST/TF	p 50
	FTP - FTP/T - FTP/I - FTP/TP	p 53
	FTSH - FTSH/T - FTSH/I - FTSH/TS - FTSH/TF	p 55

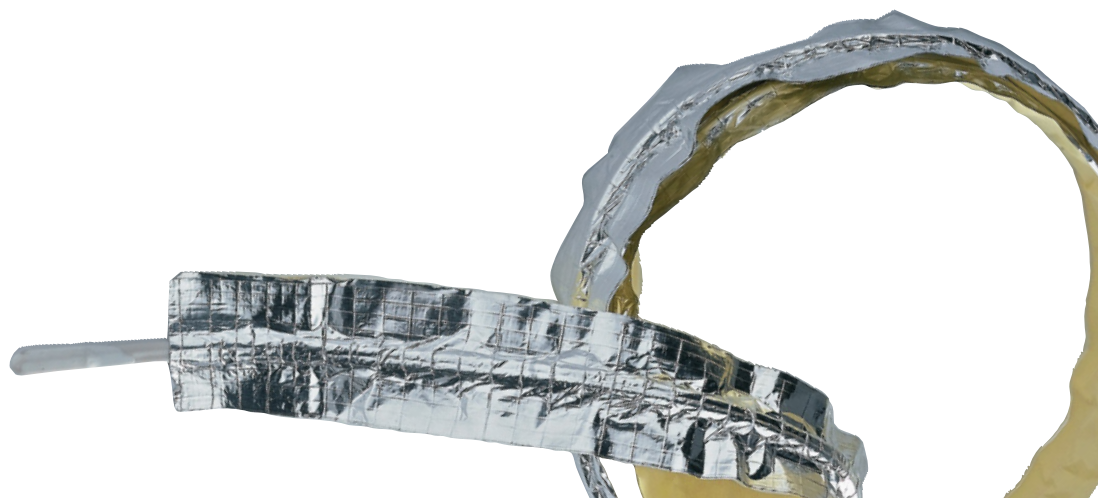

FLEXELEC's strength lies in its ability to discover and innovate. Customised manufacturing is often a necessity. Flexible heating elements continue to surprise by the range of new applications made possible, as well as more and more exotic future developments!



## PRINTING INDUSTRY

- Activate drying, preheat media or ink tanks. The printing industry requires flexible heating elements to optimise output and the quality of its publications, often by means of customised resistors designed to fit the dimensions and requirements of each process.

### FLEXELEC products:

<b>FLEXMAT</b>	T - TA - TV - TP	p 76-77
	A	p 75



## WEATHER FORECASTING

- Eliminating problems of frost on wind and rain gauges and other weather-forecasting equipment is a delicate technical challenge. So as not to influence readings, the heating elements are integrated into spaces or on very special shapes.

### FLEXELEC products:

<b>FLEXMAT</b>	T - TA - TV - TP	p 76-77
----------------	------------------	---------



## SPORTS EQUIPMENT

- Sports equipment materials or the uses to which they are put are often a source of very special applications in which the flexible heating element is a real plus for manufacturers and users alike.

Example: drying amateur or professional ski boots, manufacturing ice hockey sticks.

### FLEXELEC products:

<b>FLEXTRACE</b>	FSO - FSO/T - FSO/TP	p 49
	FST - FST/T - FST/I - FST/TP - FST/TF	p 50

<b>FLEXMAT</b>	T - TA - TV - TP	p 76-77
----------------	------------------	---------



## AERIALS

- Defrosting satellite dishes is essential to ensure continuous broadcasting on radio, TV or military channels. Cable or fabric heating elements are laid out on the back of the receiver.

### FLEXELEC products:

<b>FLEXCORD</b>	C1S - C1S/T - C1S/I	p 23
-----------------	---------------------	------

<b>FLEXTRACE</b>	FSO - FSO/T - FSO/TP	p 49
	FST - FST/T - FST/I - FST/TP - FST/TF	p 50
	FTP - FTP/T - FTP/I - FTP/TP	p 53
	FTSH - FTSH/T - FTSH/I - FTSH/TS - FTSH/TF	p 55

<b>FLEXMAT</b>	T - TA - TV - TP	p 76-77
----------------	------------------	---------



## APPLICATIONS DIVERSES



### CASH DISPENSERS

- Distributing the right number of banknotes involves checking that condensation doesn't make them stick together. With this in view, heating cords or flexes keep the storage bay dry.

#### FLEXELEC products:

<b>FLEXCORD</b>	C1P - C1P/T - C1P/I	p 22
	C1S - C1S/T - C1S/I	p 23
	C1F - C1F/T - C1F/I	p 24



### WIND GENERATORS

- Speed up the drying process for the resin of wind generator blades during manufacture or on-site repairs after damage such as that caused by birds, for example. Silicon Heating mats are especially recommended for the uniform heating they provide.

#### FLEXELEC products:

<b>FLEXMAT</b>	T - TA - TV - TP	p 76-77
----------------	------------------	---------



### VACUUM PUMPS

- Taking vacuum to its extremes requires the use of external means of raising the temperature of equipment using fabrics or tapes that heat the network as continuously as possible.

#### FLEXELEC products:

<b>FLEXMAT</b>	T - TA - TV - TP	p 76-77
<b>FLEXTAPE</b>	RV/I	p 42



### BATTERIES

- Keeping batteries from freezing, permanently or during programmed cycles is paramount for obtaining a reliable main or emergency electrical supply. This protection can significantly extend the lifetime of this equipment.

#### FLEXELEC products:

<b>FLEXTRACE</b>	FSO - FSO/T - FSO/TP	p 49
	FST - FST/T - FST/I - FST/TP - FST/TF	p 50
<b>FLEXMAT</b>	T - TA - TV - TP	p 76-77
	A	p 75



### BILLIARD TABLES

- Counter variations in air humidity and temperature differences in the slate, which are detrimental to the speed and trueness of billiard balls for high-level players, by fixing heating cables to the bottom of the frame. This has the additional advantage of making the tables smoother and quieter.

#### FLEXELEC products:

<b>FLEXFLOOR</b>	KY	p 68
------------------	----	------



### HORTICULTURE

- Force seedlings, or simulate the seasonal climate ahead of time to improve management of flower and vegetable production cycles, by inserting a network of heating cables in the ground to deliver heat as close as possible to the plants.

#### FLEXELEC products:

<b>FLEXFLOOR</b>	KY - KYCY	p 68
	KCYR	p 69



# Flexible heating cables and elements temperature maintenance systems

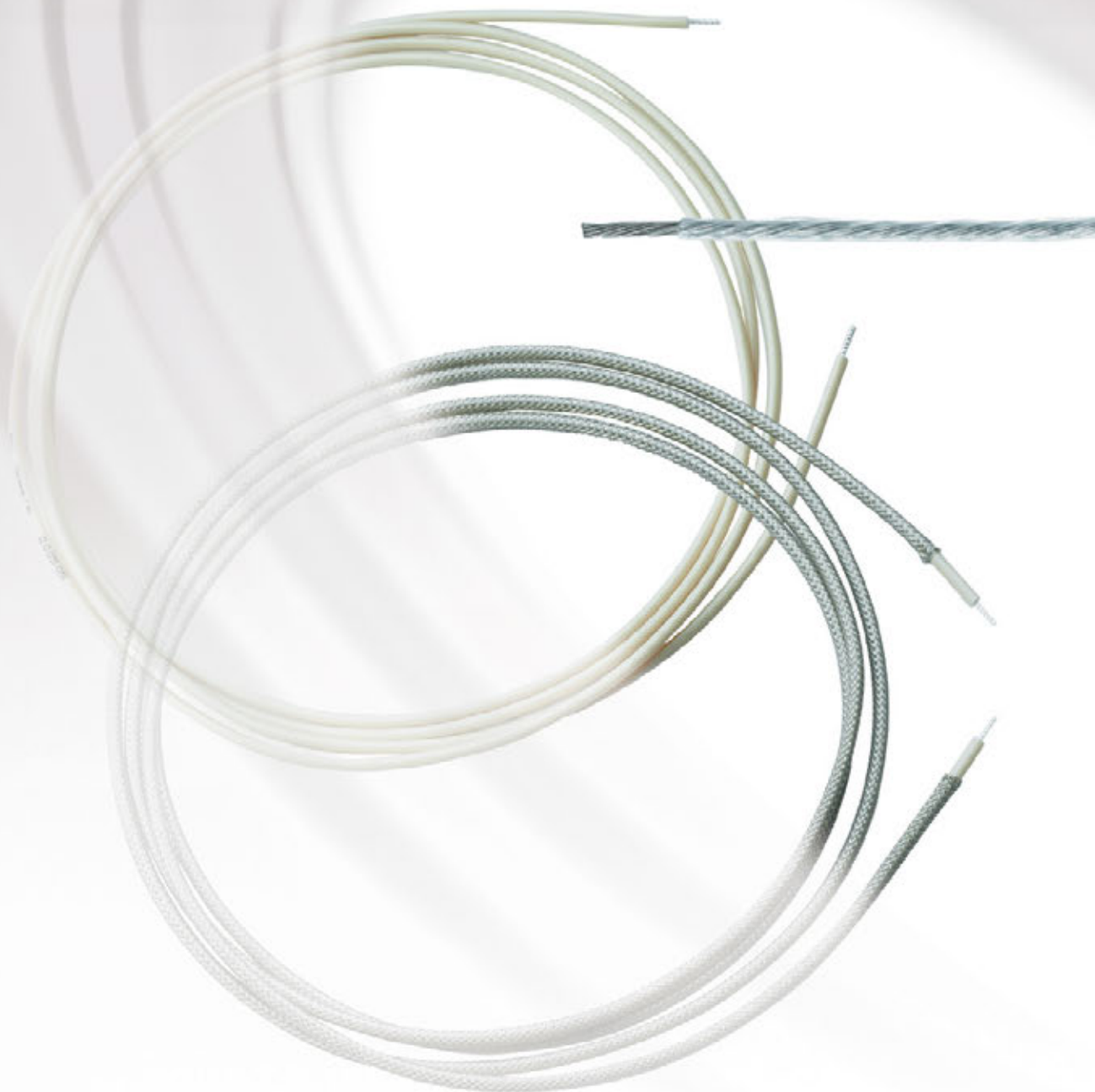

## **FLEXCORD®**

### HEATING CORDS

C1P - C1P/T - C1P/I	PVC INSULATED CORDS	22
C1S - C1S/T - C1S/I	SILICON ELASTOMER INSULATED CORDS	23
C1F - C1F/T - C1F/I	FLUOROPOLYMER INSULATED CORDS	24

## TEMPERATURE MAINTENANCE SYSTEMS

### C1P - C1P/T - C1P/I PVC insulated cords



#### Characteristics

- cords on request.
- C1P : PVC insulated cords.
- C1P/T : with tinned copper braid for mechanical protection and earthing.
- C1P/I : with stainless steel braid for mechanical protection and earthing.
- Special production on request.

#### Applications

C1P, C1P/T and C1P/I heating cables are mainly used in the household electrical or refrigeration industries, or in machines requiring protection against freezing or temperature maintenance.

To ensure that these heating elements enjoy a long service life, we recommend using a control device.



#### Standards

CEI 62395-1  
CEI 62395-2  
UL758 (UL) on request  
C22.2 N° 210 (cUL) on request

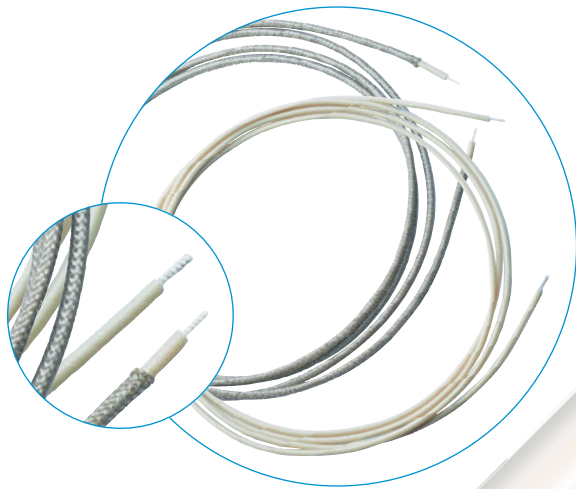

PRODUCTS	INSULATION CLASS
C1P	CLASS 0 (single insulated) CLASS III (if low voltage)
C1P/T - C1P/I	CLASS I (earthing)

PVC insulation 105°C  
(C1P)

Metal braid  
(C1P/T - C1P/I)

	C1P	C1P/T - C1P/I
Support	Fibre class Ø 0.7 or Ø 1.1 mm	
Heating wire	Nickel-Copper or Nickel-Chrome	
Diameter	2.0 to 3.0 mm	2.3 to 3.3 mm
Max. ohmic value	5000 Ω/m	
Max. power	15 W/m	
Max. voltage	600 V	
Permissible surface temperature	From - 30°C to + 105°C	
Tolerances	Resistance : ± 10 % Diameter : + 0.2 / - 0.1 mm	
Minimum bending radius	6 x the diameter	

#### Use

Heating cords are series resistors. Consult the pages of the catalogue devoted to the corresponding general operating principles, general instructions for use and accessories.

#### FLEXELEC S.A.S

10, rue des frères Lumière  
Z.A. du Bois Rond  
69720 ST BONNET DE MURE - FRANCE  
Tél : + 33 (0)4.72.48.30.90

E-mail : [flexelec@omerin.com](mailto:flexelec@omerin.com)

#### FLEXELEC Dept

OMERIN ASIA Pte Ltd  
51 Goldhill Plaza #08-11  
SINGAPORE 308900  
Tel : + 65 6255 4778  
Fax : + 65 6255 4779  
E-mail : [sales@omerin.com.sg](mailto:sales@omerin.com.sg)

#### FLEXELEC (UK) Ltd

Unit 11 Kings Park Industrial Estate  
Primrose Hill - KINGS LANGLEY  
Hertfordshire - WD4 8ST - UK  
Tel : + 44 (0) 1923.274477  
Fax : + 44 (0) 1923.270264  
E-mail : [sales@omerin.co.uk](mailto:sales@omerin.co.uk)

#### FLEXELEC Dept

OMERIN GmbH  
Buchwiese 16  
D-65510 IDSTEIN - GERMANY  
Tel : + 49 (0) 6126.94.31-0  
Fax : + 49 (0) 6126.83.999  
E-mail : [omerinmbh@omerin.com](mailto:omerinmbh@omerin.com)

## TEMPERATURE MAINTENANCE SYSTEMS

### C1S - C1S/T - C1S/I Silicon elastomer cords



#### Characteristics

- cords on request.
- C1S : silicon elastomer cords.
- C1S/T : with tinned copper braid for mechanical protection and earthing.
- C1S/I : with stainless steel braid for mechanical protection and earthing.
- Special production on request.

#### Applications

C1S, C1S/T and C1S/I heating cords are mainly used in the household electrical or refrigeration industries, or in machines requiring protection against freezing or temperature maintenance.

To ensure that these heating elements enjoy a long service life, we recommend using a control device.



#### Standards

CEI 62395-1  
CEI 62395-2  
UL758 (UL) on request  
C22.2 N° 210 (cUL) on request

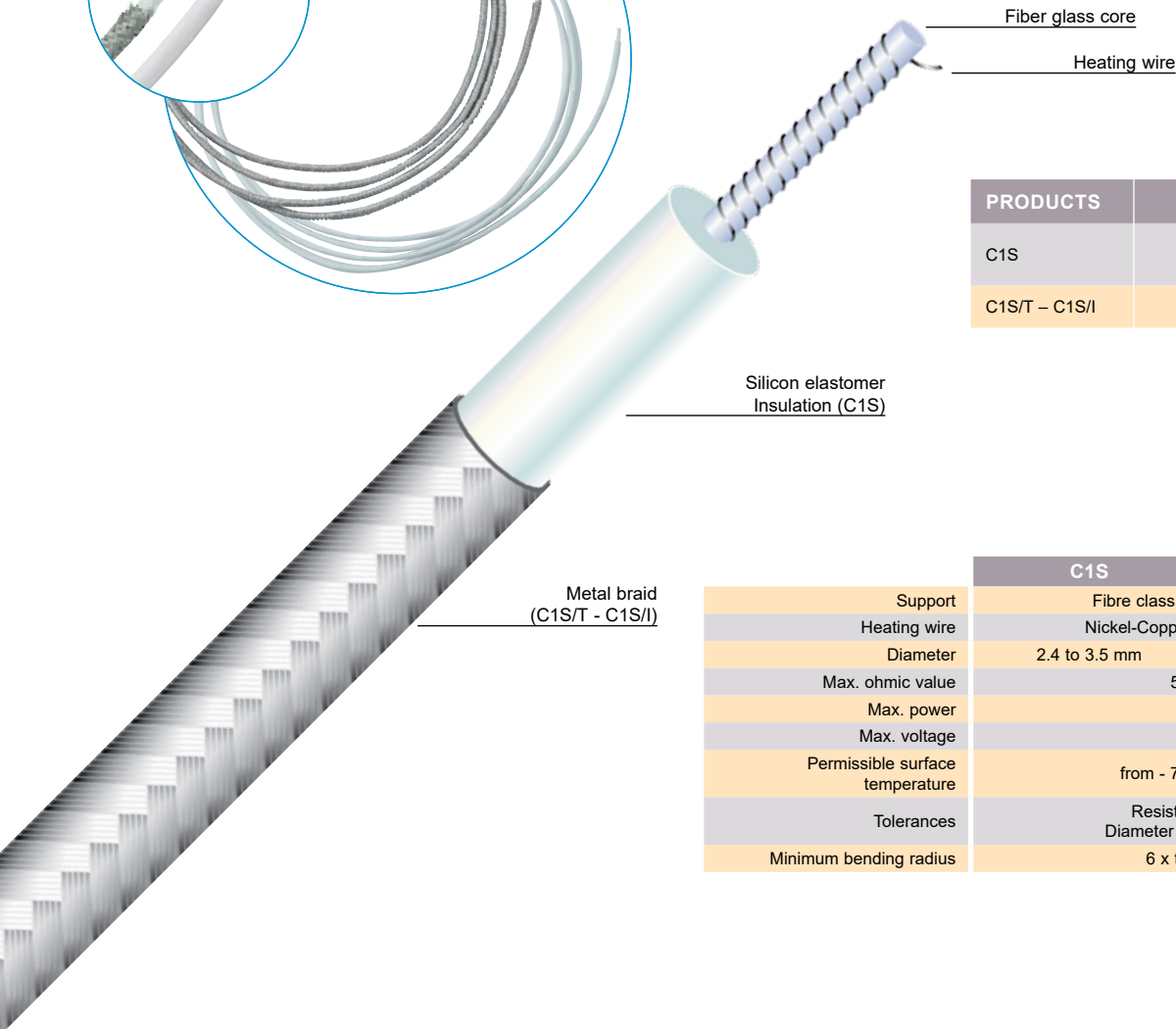
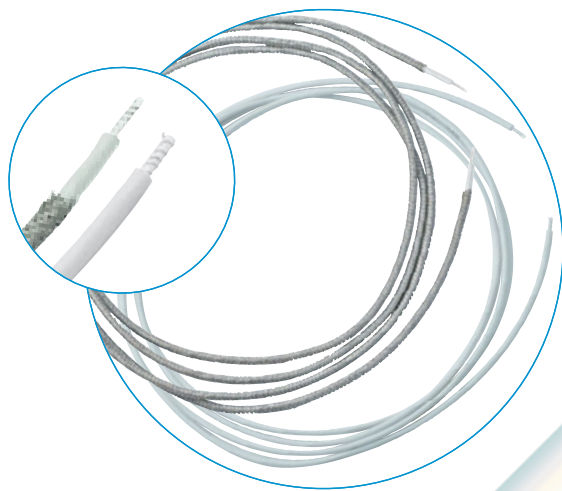

PRODUCTS	INSULATION CLASS
C1S	CLASS 0 (single insulated) CLASS III (if low voltage)
C1S/T - C1S/I	CLASS I (earthing)

	C1S	C1S/T - C1S/I
Support	Fibre class Ø 0.7 or Ø 1.1 mm	
Heating wire	Nickel-Copper or Nickel-Chrome	
Diameter	2.4 to 3.5 mm	2.7 to 3.8 mm
Max. ohmic value	5000 Ω/m	
Max. power	30 W/m	
Max. voltage	600 V	
Permissible surface temperature	from - 70°C to + 200°C	
Tolerances	Resistance : ± 10 % Diameter : + 0.2 / - 0.1 mm	
Minimum bending radius	6 x the diameter	

#### Use

Heating cords are series resistors. Consult the pages of the catalogue devoted to the corresponding general operating principles, general instructions for use and accessories.

#### FLEXELEC S.A.S

10, rue des frères Lumière  
Z.A. du Bois Rond  
69720 ST BONNET DE MURE - FRANCE  
Tél : + 33 (0)4.72.48.30.90

E-mail : [flexelec@omerin.com](mailto:flexelec@omerin.com)

#### FLEXELEC Dept

OMERIN ASIA Pte Ltd  
51 Goldhill Plaza #08-11  
SINGAPORE 308900  
Tel : + 65 6255.4778  
Fax : + 65 6255.4779

E-mail : [sales@omerin.com.sg](mailto:sales@omerin.com.sg)

#### FLEXELEC (UK) Ltd

Unit 11 Kings Park Industrial Estate  
Primrose Hill - KINGS LANGLEY  
Hertfordshire - WD4 8ST - UK  
Tel : + 44 (0) 1923.274477  
Fax : + 44 (0) 1923.270264

E-mail : [sales@omerin.co.uk](mailto:sales@omerin.co.uk)

#### FLEXELEC Dept

OMERIN GmbH  
Buchwiese 16  
D-65510 IDSTEIN - GERMANY  
Tel : + 49 (0) 6126.94.31-0  
Fax : + 49 (0) 6126.83.999

E-mail : [omerinmbh@omerin.com](mailto:omerinmbh@omerin.com)



## TEMPERATURE MAINTENANCE SYSTEMS

### C1F - C1F/T - C1F/I Fluoropolymer insulated cords



#### Characteristics

-  cords on request.
- C1F : Fluoropolymer insulated cords.
- C1F/T : with tinned copper braid for mechanical protection and earthing.
- C1F/I : with stainless steel braid for mechanical protection and earthing.
- Special production on request.

#### Applications

C1F, C1F/T and C1F/I heating cords are mainly used in corrosive environments, or in machines requiring protection against freezing or temperature maintenance.

To ensure that these heating elements enjoy a long service life, we recommend using a control device.



#### Standards

CEI 62395-1  
CEI 62395-2

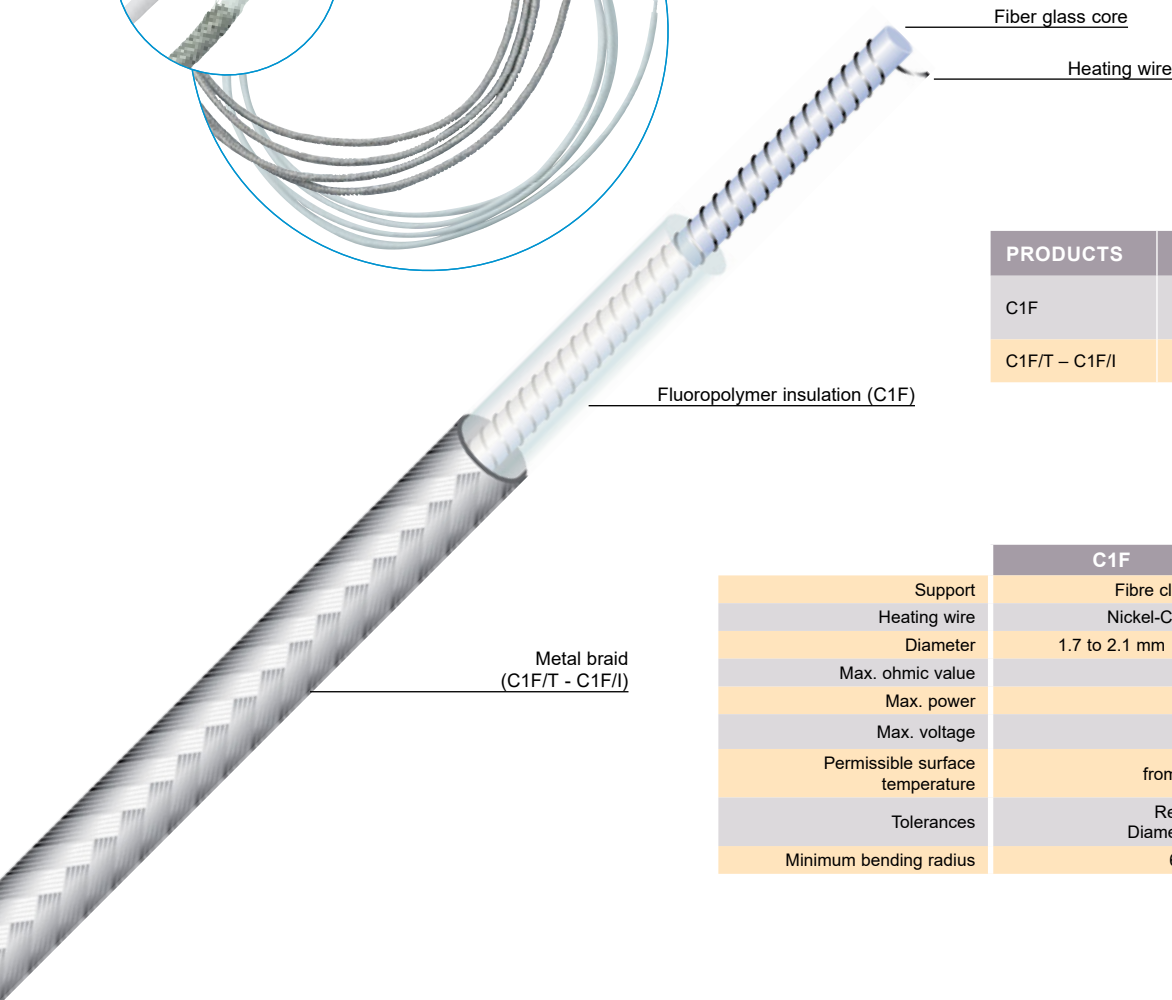
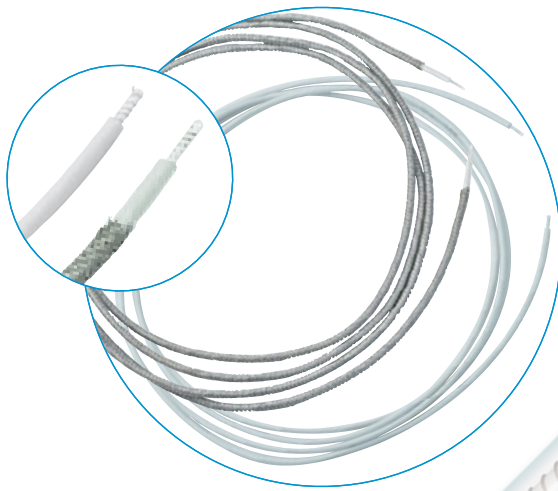

PRODUCTS	INSULATION CLASS
C1F	CLASS 0 (single insulated) CLASS III (if low voltage)
C1F/T - C1F/I	CLASS I (earthing)

	C1F	C1F/T - C1PF/I
Support	Fibre class Ø 0.7 or Ø 1.1 mm	
Heating wire	Nickel-Copper or Nickel-Chrome	
Diameter	1.7 to 2.1 mm	2.0 to 2.4 mm
Max. ohmic value	5000 Ω/m	
Max. power	30 W/m	
Max. voltage	600 V	
Permissible surface temperature	from - 70°C to + 200°C	
Tolerances	Resistance : ± 10 % Diameter : + 0.2 / - 0.1 mm	
Minimum bending radius	6 x the diameter	

#### Use

Heating cords are series resistors. Consult the pages of the catalogue devoted to the corresponding general operating principles, general instructions for use and accessories.

#### FLEXELEC S.A.S

10, rue des frères Lumière  
Z.A. du Bois Rond  
69720 ST BONNET DE MURE - FRANCE  
Tél : + 33 (0)4.72.48.30.90

E-mail : [flexelec@omerin.com](mailto:flexelec@omerin.com)

#### FLEXELEC Dept

OMERIN ASIA Pte Ltd  
51 Goldhill Plaza #08-11  
SINGAPORE 308900  
Tel : + 65 6255 4778  
Fax : + 65 6255 4779  
E-mail : [sales@omerin.com.sg](mailto:sales@omerin.com.sg)

#### FLEXELEC (UK) Ltd

Unit 11 Kings Park Industrial Estate  
Primrose Hill - KINGS LANGLEY  
Hertfordshire - WD4 8ST - UK  
Tel : + 44 (0) 1923.274477  
Fax : + 44 (0) 1923.270264  
E-mail : [sales@omerin.co.uk](mailto:sales@omerin.co.uk)

#### FLEXELEC Dept

OMERIN GmbH  
Buchwiese 16  
D-65510 IDSTEIN - GERMANY  
Tel : + 49 (0) 6126.94.31-0  
Fax : + 49 (0) 6126.83.999  
E-mail : [omerimgbh@omerin.com](mailto:omerimgbh@omerin.com)

# Flexible heating cables and elements temperature maintenance systems



## **FLEXUNIT®**

### HEATING CABLES

CP - CP/T - CP/TW - CP/I - CP/IW	PVC INSULATED CABLES	26
CS - CS/T - CS/TW - CS/I - CS/IW	SILICON ELASTOMER INSULATED CABLES	27
CP1	TERMINATED PVC INSULATED CABLES	28
CS1	TERMINATED SILICON ELASTOMER INSULATED CABLES	29
CS2 - CS2/T - CS2/TW - CS2/I - CS2/IW	SILICON ELASTOMER INSULATED CABLES	30
CV/I	GLASS FIBRE INSULATED CABLES	31
TUY	FLEXIBLE HEATED HOSES	32

## TEMPERATURE MAINTENANCE SYSTEMS

### CP - CP/T - CP/TW - CP/I - CP/IW PVC insulated cables



#### Characteristics

- Power cable: standard length: 1 m.
- CP : PVC insulated cables.
- CP/T : with tinned copper braid and earthing conductor.
- CP/TW : with tinned copper braid no earthing conductor.
- CP/I : with stainless steel braid and earthing conductor.
- CP/IW : with stainless steel braid no earthing conductor.
- Special production on request.

#### Applications

CP, CP/T, CP/TW, CP/I and CP/IW heating cables are mainly used in the household electrical and refrigeration industries and for equipment where protection against freezing or temperature maintenance is necessary.

To ensure that these heating elements enjoy a long service life, we recommend using a control device.



#### Standards

CEI 62395-1  
CEI 62395-2

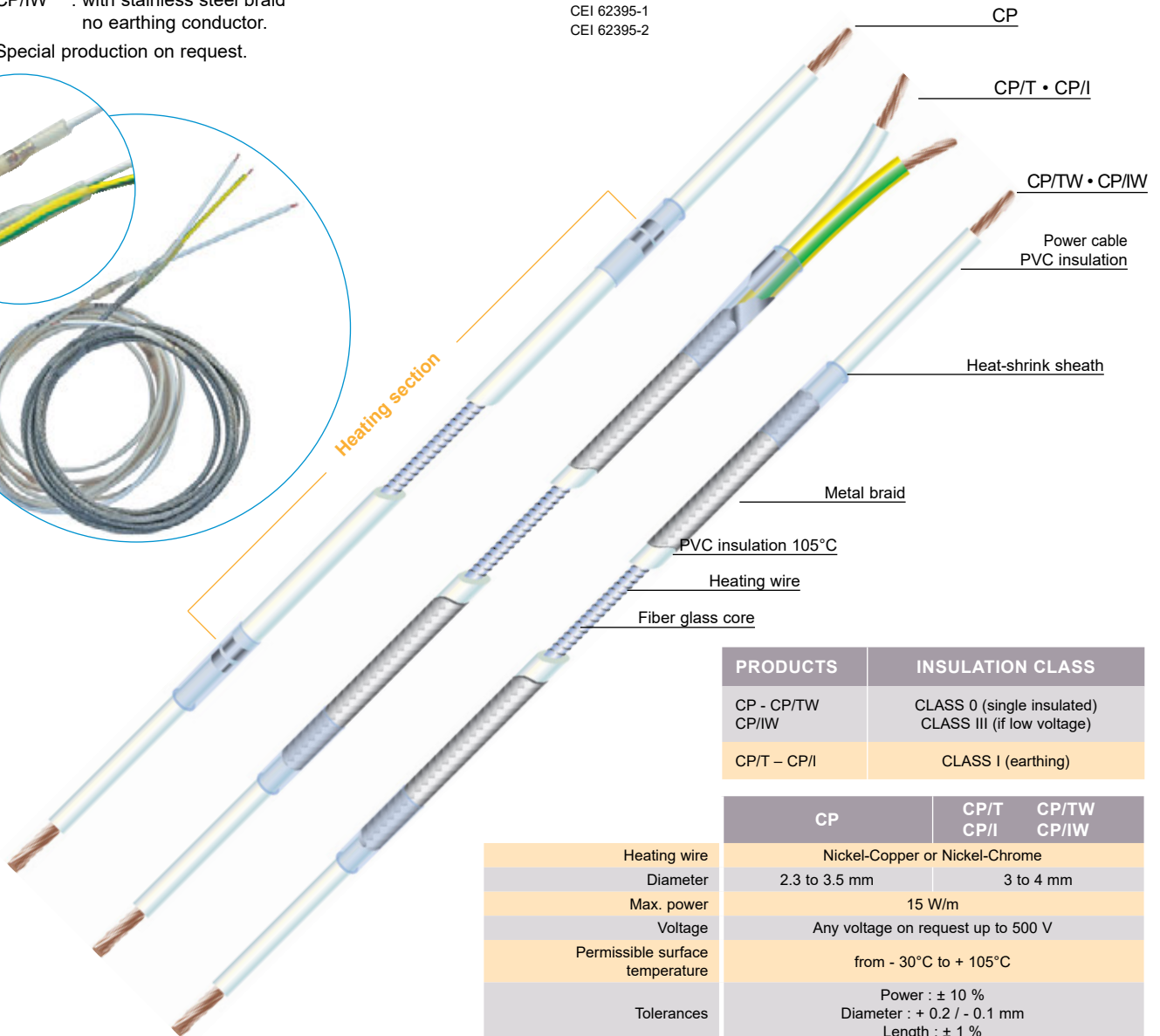

PRODUCTS	INSULATION CLASS
CP - CP/TW CP/IW	CLASS 0 (single insulated) CLASS III (if low voltage)
CP/T - CP/I	CLASS I (earthing)

	CP	CP/T CP/I	CP/TW CP/IW
Heating wire	Nickel-Copper or Nickel-Chrome		
Diameter	2.3 to 3.5 mm	3 to 4 mm	
Max. power	15 W/m		
Voltage	Any voltage on request up to 500 V		
Permissible surface temperature	from - 30°C to + 105°C		
Tolerances	Power : ± 10 % Diameter : + 0.2 / - 0.1 mm Length : ± 1 %		
Connection insulation	Heat-shrink sheath with adhesive		
Ingress protection code	IP 55		
Minimum bending radius	6 x the diameter		

#### Use

Heating cables are series resistors. Consult the pages of the catalogue devoted to the corresponding general operating principles, general instructions for use and accessories.

**TEMPERATURE MAINTENANCE SYSTEMS**

**CS - CS/T - CS/TW - CS/I - CS/IW**  
**Silicon elastomer insulated cables**



**Characteristics**

- Connection insulated with a silicon moulding.
- Power cable: standard length: 1 m.
- CS : silicon elastomer insulated cables.
- CS/T : with tinned copper braid and earthing conductor.
- CS/TW : with tinned copper braid for mechanical protection, no earthing conductor.
- CS/I : with stainless steel braid and earthing conductor.
- CS/IW : with stainless steel braid for mechanical protection, no earthing conductor.
- Special production on request.

**Applications**

CS, CS/T, CS/TW, CS/I and CS/IW heating cables are mainly used in the household electrical and refrigeration industries and for equipment where protection against freezing or temperature maintenance is necessary.

To ensure that these heating elements enjoy a long service life, we recommend using a control device.



**Standards**

- CEI 62395-1
- CEI 62395-2

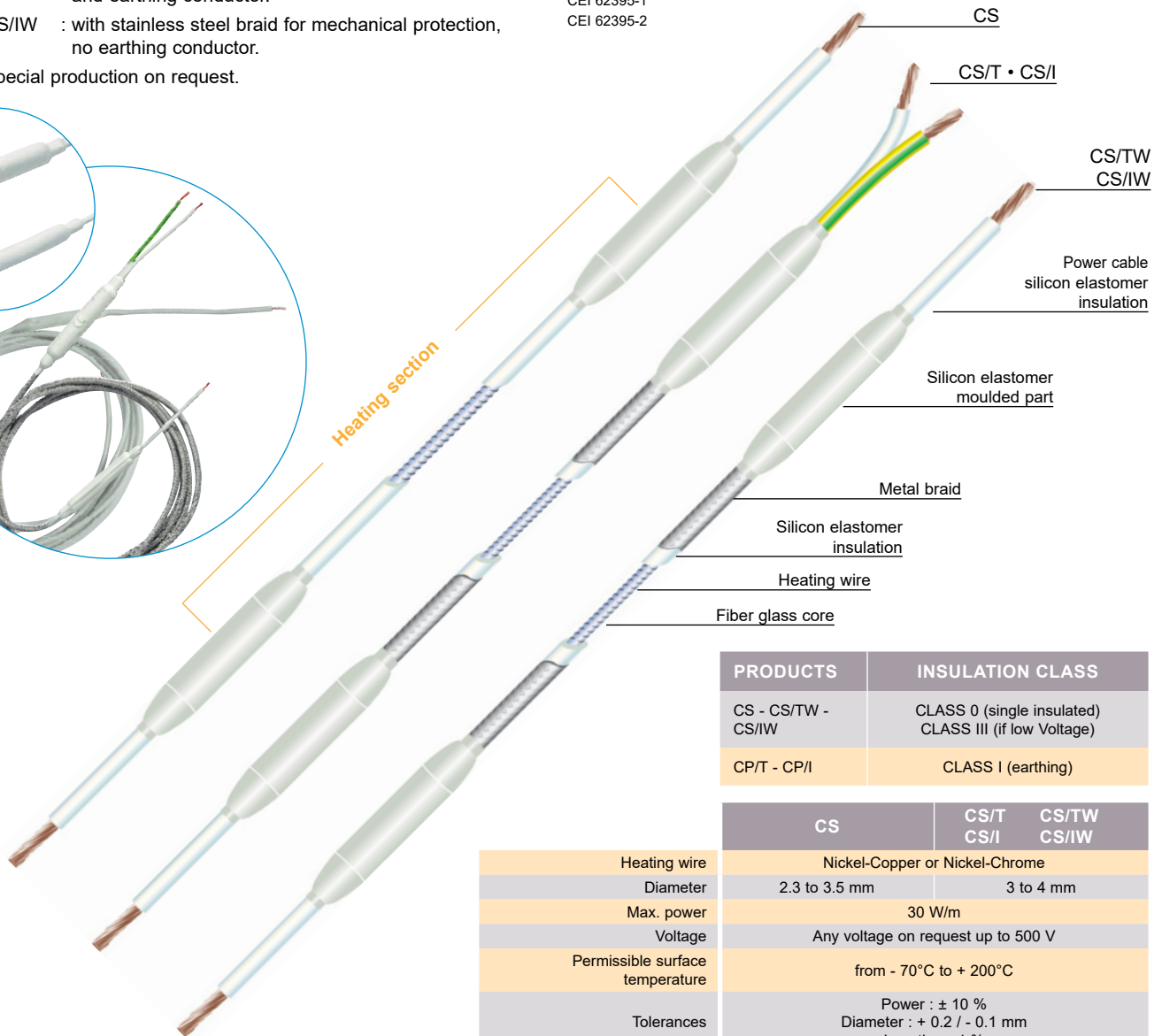
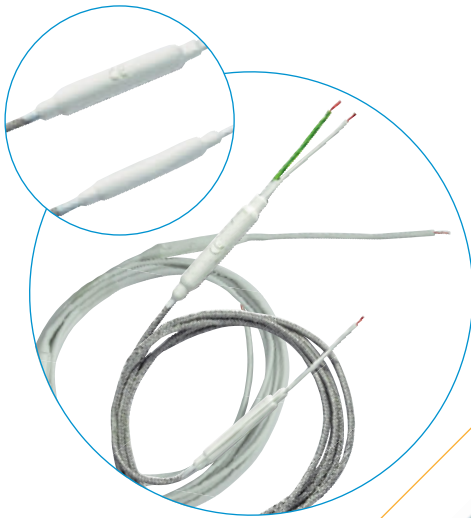

PRODUCTS	INSULATION CLASS
CS - CS/TW - CS/IW	CLASS 0 (single insulated) CLASS III (if low Voltage)
CP/T - CP/I	CLASS I (earthing)

	CS	CS/T CS/I	CS/TW CS/IW
Heating wire	Nickel-Copper or Nickel-Chrome		
Diameter	2.3 to 3.5 mm		3 to 4 mm
Max. power	30 W/m		
Voltage	Any voltage on request up to 500 V		
Permissible surface temperature	from - 70°C to + 200°C		
Tolerances	Power : ± 10 % Diameter : + 0.2 / - 0.1 mm Length : ± 1 %		
Connection insulation	Sealed silicon moulding		
Ingress protection code	IP 66		
Minimum bending radius	6 x the diameter		

**Use**

Heating cables are series resistors. Consult the pages of the catalogue devoted to the corresponding general operating principles, general instructions for use and accessories.

**FLEXELEC S.A.S**

10, rue des frères Lumière  
Z.A. du Bois Rond  
69720 ST BONNET DE MURE - FRANCE  
Tél : + 33 (0)4.72.48.30.90  
E-mail : flexelec@omerin.com

**FLEXELEC Dept**

OMERIN ASIA Pte Ltd  
51 Goldhill Plaza #08-11  
SINGAPORE 308900  
Tel : + 65 6255.4778  
Fax : + 65 6255.4779  
E-mail : sales@omerin.com.sg

**FLEXELEC (UK) Ltd**

Unit 11 Kings Park Industrial Estate  
Primrose Hill - KINGS LANGLEY  
Hertfordshire - WD4 8ST - UK  
Tel : + 44 (0) 1923.274477  
Fax : + 44 (0) 1923.270264  
E-mail : sales@omerin.co.uk

**FLEXELEC Dept**

OMERIN GmbH  
Buchwiese 16  
D-65510 IDSTEIN - GERMANY  
Tel : + 49 (0) 6126.94.31-0  
Fax : + 49 (0) 6126.83.999  
E-mail : omeringmbh@omerin.com

**TEMPERATURE MAINTENANCE SYSTEMS**

**CP1 Terminated PVC insulated cables**



**Characteristics**

The main characteristic of this type of cable is that there is no extra thickness at the cold junction, identified with a black mark

- cables on request.
- Special production on request.

**Applications**

CP1 heating cables are mainly incorporated in household electrical or refrigeration equipment and special, mass-produced machines requiring protection against freezing or temperature maintenance.

To ensure that these heating elements enjoy a long service life, we recommend using a control device.



**Standards**

- CEI 62395-1
- CEI 62395-2
- UL758 (UL) on request
- C22.2 N° 210 (cUL) on request



Other possible options

CP1 Termination

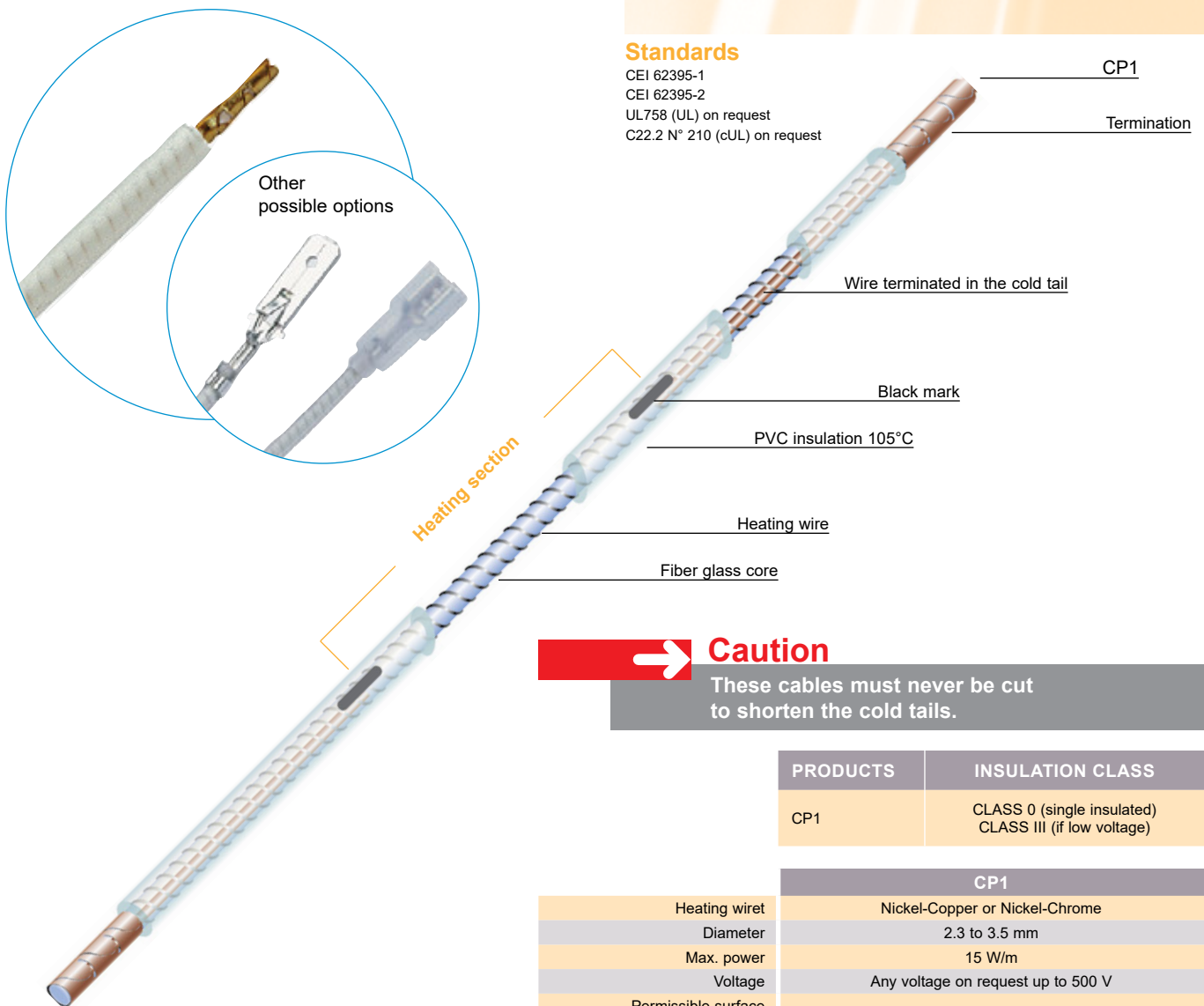

**Caution**  
 These cables must never be cut to shorten the cold tails.

**Use**

Heating cables are series resistors. Consult the pages of the catalogue devoted to the corresponding general operating principles, general instructions for use and accessories.

PRODUCTS	INSULATION CLASS
CP1	CLASS 0 (single insulated) CLASS III (if low voltage)

CP1	
Heating wire	Nickel-Copper or Nickel-Chrome
Diameter	2.3 to 3.5 mm
Max. power	15 W/m
Voltage	Any voltage on request up to 500 V
Permissible surface temperature	from - 30°C to + 105°C
Tolerances	Power : ± 10 % Diameter : + 0.2 / - 0.1 mm Length : ± 1 %
Max. current	2 A
Ingress protection code	IP 66
Minimum bending radius	6 x the diameter

**TEMPERATURE MAINTENANCE SYSTEMS**

**CS1**

**Terminated silicon elastomer insulated cables**



**Characteristics**

The main characteristic of this type of cable is that there is no extra thickness at the cold junction, identified with a black mark.

- cables on request.
- Special production on request.

**Applications**

CS1 heating cables are mainly incorporated in household electrical or refrigeration equipment and special, mass-produced machines requiring protection against freezing or temperature maintenance.

To ensure that these heating elements enjoy a long service life, we recommend using a control device.



**Standards**

- CEI 62395-1
- CEI 62395-2
- UL758 (UL) on request
- C22.2 N° 210 (cUL) on request

CS1

Termination

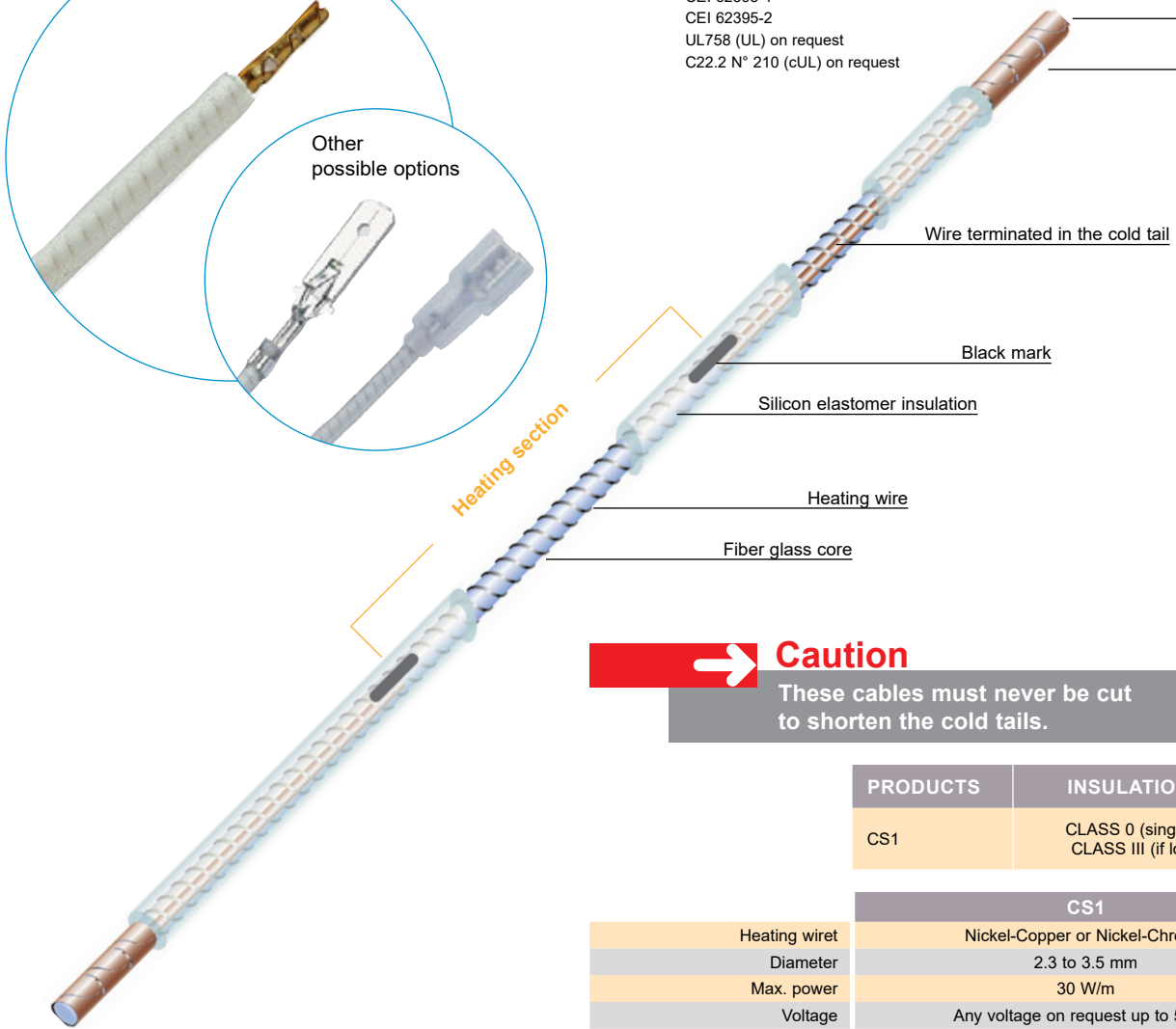
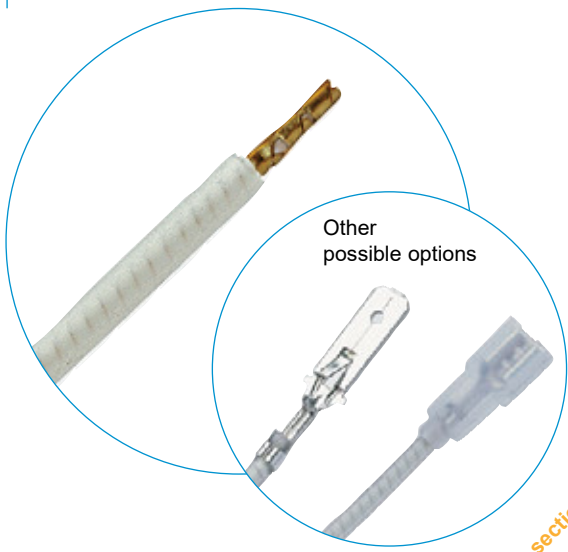

**Caution**  
 These cables must never be cut to shorten the cold tails.

PRODUCTS	INSULATION CLASS
CS1	CLASS 0 (single insulated) CLASS III (if low Voltage)

CS1	
Heating wire	Nickel-Copper or Nickel-Chrome
Diameter	2.3 to 3.5 mm
Max. power	30 W/m
Voltage	Any voltage on request up to 500 V
Permissible surface temperature	from - 70°C to + 200°C
Tolerances	Power : ± 10 % Diameter : + 0.2 / - 0.1 mm Length : ± 1 %
Max.current	2 A
Ingress protection code	IP 66
Minimum bending radius	6 x the diameter

**Use**

Heating cables are series resistors. Consult the pages of the catalogue devoted to the corresponding general operating principles, general instructions for use and accessories.

**TEMPERATURE MAINTENANCE SYSTEMS**

**CS2 - CS2/T - CS2/TW - CS2/I - CS2/IW**  
**Silicon elastomer insulated cables**



**Characteristics**

- Power cable: standard length: 1 m.
- CS2 : Silicon elastomer insulated cables
- CS2/T : with tinned copper braid and earthing conductor.
- CS2/I : with stainless steel braid and earthing conductor.
- CS2/TW : with tinned copper braid for mechanical protection, no earthing conductor.
- CS2/IW : with stainless steel braid for mechanical protection, no earthing conductor.
- Special production on request.

**Applications**

CS2, CS2/T, CS2/I, CS2/TW and CS2/IW heating cables are mainly used in the household electrical and refrigeration industries and for machines where protection against freezing or temperature maintenance is necessary.

To ensure that these heating elements enjoy a long service life, we recommend using a control device.



**Standards**

CEI 62395-1  
CEI 62395-2

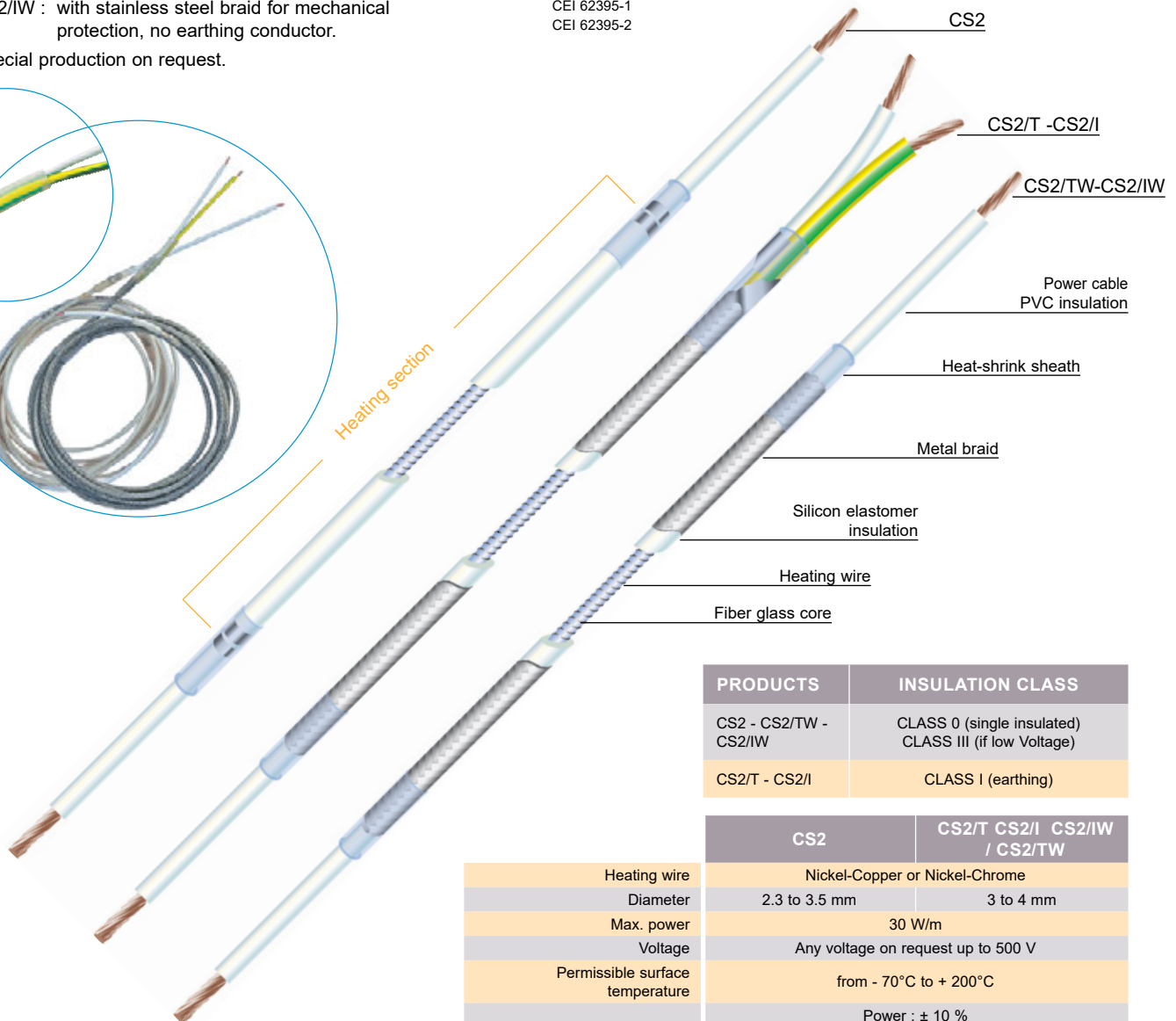
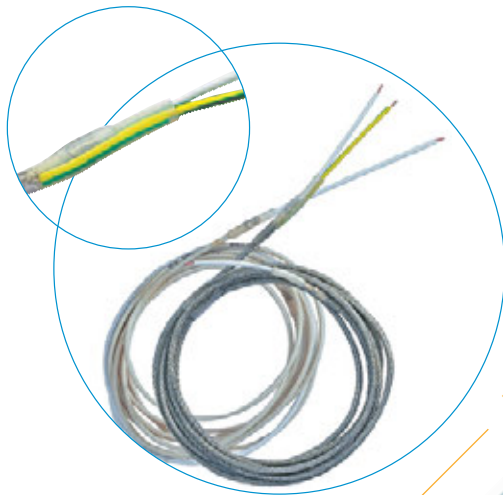

PRODUCTS	INSULATION CLASS
CS2 - CS2/TW - CS2/IW	CLASS 0 (single insulated) CLASS III (if low Voltage)
CS2/T - CS2/I	CLASS I (earthing)

	CS2	CS2/T CS2/I CS2/IW / CS2/TW
Heating wire	Nickel-Copper or Nickel-Chrome	
Diameter	2.3 to 3.5 mm	3 to 4 mm
Max. power	30 W/m	
Voltage	Any voltage on request up to 500 V	
Permissible surface temperature	from - 70°C to + 200°C	
Tolerances	Power : ± 10 % Diameter : + 0.2 / - 0.1 mm Length : ± 1 %	
Connection insulation	Heat-shrink sheath with adhesive	
Ingress protection code	IP 54	
Minimum bending radius	6 x the diameter	

**Use**

Heating cables are series resistors. Consult the pages of the catalogue devoted to the corresponding general operating principles, general instructions for use and accessories.

## TEMPERATURE MAINTENANCE SYSTEMS

## CV/I Fibre glass insulated cables



### Characteristics

- Highly flexible.
- High power: 125 W/m.
- High temperature, up to 450°C.
- Not protected against humidity.
- Minimum bend greater than 10 mm.
- Power cable : standard length 500 mm.
- Fibre glass insulated cables with stainless steel braid and earthing conductor.
- Special production on request.

### Applications

Fibre glass insulated CV/I heating cables are mainly for use in laboratories and in industrial applications when it is required to heat quickly to a high temperature. These cables are very flexible but as they are not sealed they can be used only in a dry atmosphere, and in compliance with the electrical protection instructions in force.

To ensure that these heating elements enjoy a long service life, we recommend using a control device.

### Standards

CEI 62395-1  
CEI 62395-2

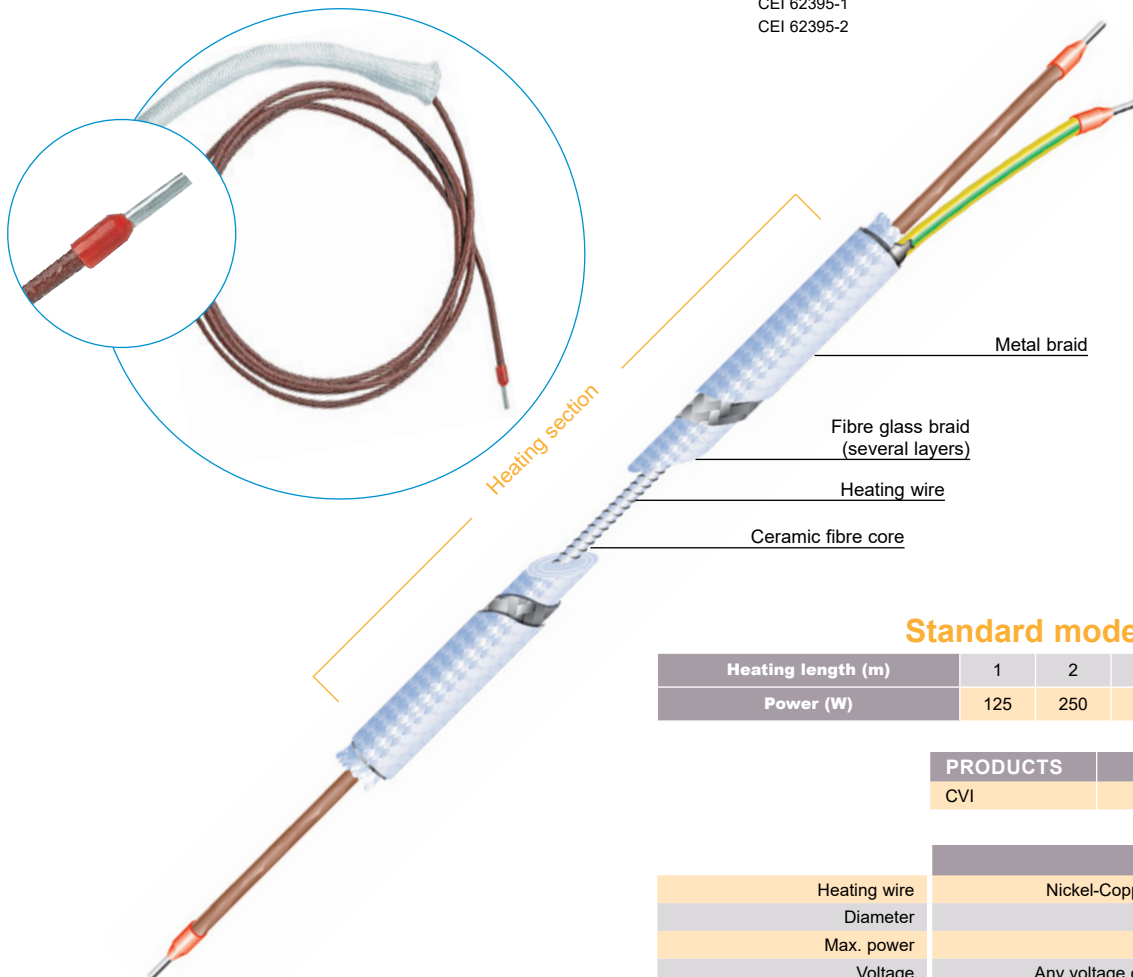

### Standard models

Heating length (m)	1	2	4	6	8	10
Power (W)	125	250	500	750	1000	1250

PRODUCTS	INSULATION CLASS
CVI	CLASS I (earthing)

	CV/I
Heating wire	Nickel-Copper or Nickel-Chrome
Diameter	5 mm
Max. power	125 W/m
Voltage	Any voltage on request up to 230 V
Permissible surface temperature	up to + 450°C
Tolerances	Power : ± 10 % Diameter : ± 0.5 mm Length : ± 1 %
Connection insulation	Fibre class
Protection	With earth
Ingress protection code	IP 40

### Use

Heating cables are series resistors. Consult the pages of the catalogue devoted to the corresponding general operating principles, general instructions for use and accessories.

#### FLEXELEC S.A.S

10, rue des frères Lumière  
Z.A. du Bois Rond  
69720 ST BONNET DE MURE - FRANCE  
Tél : + 33 (0)4.72.48.30.90

E-mail : flexelec@omerin.com

#### FLEXELEC Dept

OMERIN ASIA Pte Ltd  
51 Goldhill Plaza #08-11  
SINGAPORE 308900  
Tel : + 65 6255.4778  
Fax : + 65 6255.4779  
E-mail : sales@omerin.com.sg

#### FLEXELEC (UK) Ltd

Unit 11 Kings Park Industrial Estate  
Primrose Hill - KINGS LANGLEY  
Hertfordshire - WD4 8ST - UK  
Tel : + 44 (0) 1923.274477  
Fax : + 44 (0) 1923.270264  
E-mail : sales@omerin.co.uk

#### FLEXELEC Dept

OMERIN GmbH  
Buchwiese 16  
D-65510 IDSTEIN - GERMANY  
Tel : + 49 (0) 6126.94.31-0  
Fax : + 49 (0) 6126.83.999  
E-mail : omeringmbh@omerin.com



### TUY Flexible heated hoses



#### Characteristics

- Temperature range : 100°C, 200°C and 250°C.
- Hose : PTFE reinforced with a stainless steel braid.
- Heating cable : PTFE insulation with braid.
- Temperature sensor : PT 100 or thermocouple J or K.
- Heat insulation : Silicon foam.
- Outer sheath : Polyamid braid.
- End pieces : Silicon caps with device to protect output cable from being ripped out.
- Voltage : 230 V, other on request.
- Connection : Revolving nuts, UNF, BSP/DKR connections, or with smooth end-pieces.
- Ingress protection code : IP 40.

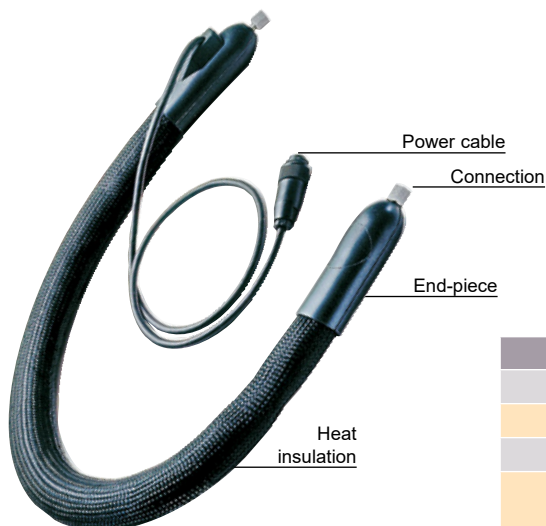

#### Applications

Flexible heated hoses are used as connecting parts between fixed and moving machine parts when it is vital to maintain these at constant temperature.

Gluing applications, hotmelt adhesive installations, the food industry, labeling machines, polyurethane foam spraying installations, oil burner conduits, gas sampling conduits for measuring purposes, etc.

To ensure that these heating elements enjoy a long service life, we recommend using a control device.



#### Options

- Stainless steel connection.
- Outer stainless or galvanised steel braid.
- Pilot lines can pass through the heated hose.
- Special designs on request.
- Electronic regulator.

Nominal diameter (mm)	4	6	8	10	13	16	20	25
External diameter (mm)	40	40	40	40	40	40	59	59
Power (W/m)	80	90	100	150	170	200	280	300
Burst pressure (bar)	1000	900	800	600	500	400	280	220
Max. service pressure								
Up to 24°C (bar)	250	225	200	150	125	100	70	55
Up to 100°C (bar)	225	202	180	135	112	90	63	49
Up to 200°C (bar)	200	180	160	120	100	80	56	44
Minimum bend with polyamide braid (mm)	160	160	160	250	250	250	450	500
Minimum bend with metal braid (mm)	200	200	200	290	290	290	500	550

#### Use

Consult the pages of the catalogue devoted to the corresponding general operating principles, general instructions for use and accessories.

#### FLEXELEC S.A.S

10, rue des frères Lumière  
Z.A. du Bois Rond  
69720 ST BONNET DE MURE - FRANCE  
Tél : + 33 (0)4.72.48.30.90

E-mail : [flexelec@omerin.com](mailto:flexelec@omerin.com)

#### FLEXELEC Dept

OMERIN ASIA Pte Ltd  
51 Goldhill Plaza #08-11  
SINGAPORE 308900  
Tel : + 65 6255 4778  
Fax : + 65 6255 4779  
E-mail : [sales@omerin.com.sg](mailto:sales@omerin.com.sg)

#### FLEXELEC (UK) Ltd

Unit 11 Kings Park Industrial Estate  
Primrose Hill - KINGS LANGLEY  
Hertfordshire - WD4 8ST - UK  
Tel : + 44 (0) 1923.274477  
Fax : + 44 (0) 1923.270264  
E-mail : [sales@omerin.co.uk](mailto:sales@omerin.co.uk)

#### FLEXELEC Dept

OMERIN GmbH  
Buchwiese 16  
D-65510 IDSTEIN - GERMANY  
Tel : + 49 (0) 6126.94.31-0  
Fax : + 49 (0) 6126.83.999  
E-mail : [omerinmbh@omerin.com](mailto:omerinmbh@omerin.com)

# Flexible heating cables and elements temperature maintenance systems



## **FLEXDRAIN®**

### **DRAIN-LINE HEATERS**

CSC - CSC/T - CSC/I - CSC/TS	SILICON ELASTOMER INSULATED DRAIN-LINE HEATERS	34
CSC2	SILICON ELASTOMER INSULATED DRAIN-LINE HEATERS	35
CSC2K	SILICON ELASTOMER INSULATED DRAIN-LINE HEATERS WITH INTEGRATED THERMOSTAT	36
CSC2M	SILICON ELASTOMER INSULATED DRAIN-LINE HEATERS MICRO SIZE FOR REFRIGERATION	37

**TEMPERATURE MAINTENANCE SYSTEMS**

## CSC - CSC/T - CSC/I - CSC/TS

### Silicon elastomer insulated drain-line heaters



#### Characteristics

- Fully sealed.
- Extremely flexible.
- Any voltage on request.
- Power cable: standard length: 1m.
- CSC : silicon elastomer insulated drain-line heaters.
- CSC/T : with tinned copper braid for earthing and mechanical protection.
- CSC/I : with stainless steel braid for earthing and mechanical protection.
- CSC/TS : with tinned copper braid and silicon elastomer insulated
- Special production on request.

#### Applications

CSC, CSC/T, CSC/I and CSC/TS heaters are designed to be laid inside pipes for draining water from thawing refrigeration equipment installed in cold rooms. They operate only during thawing cycles.

To ensure that these heating elements enjoy a long service life, we recommend using a control device.



#### Standards

CEI 62395-1  
CEI 62395-2

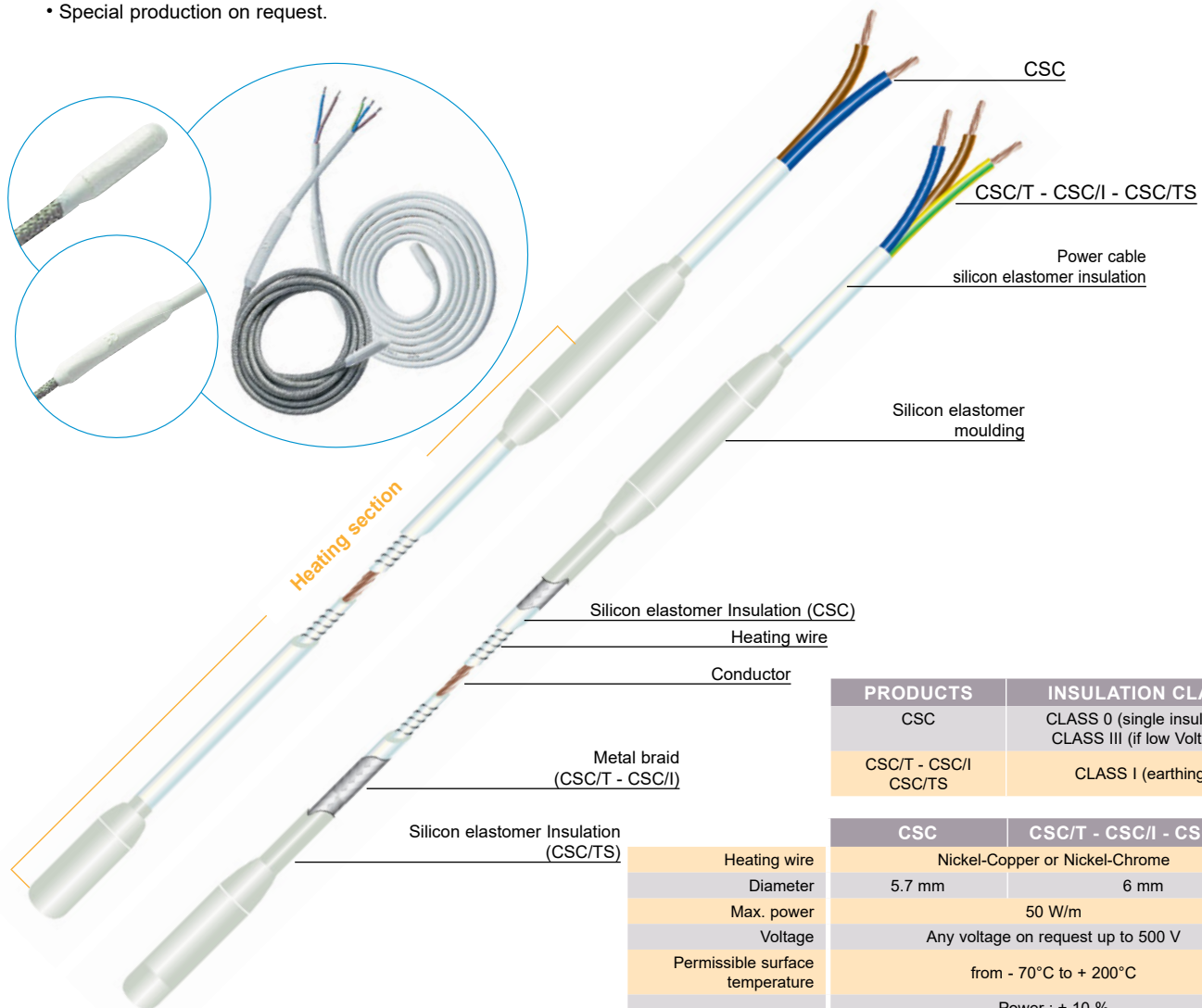

PRODUCTS	INSULATION CLASS
CSC	CLASS 0 (single insulated) CLASS III (if low Voltage)
CSC/T - CSC/I CSC/TS	CLASS I (earthing)

	CSC	CSC/T - CSC/I - CSC/TS
Heating wire	Nickel-Copper or Nickel-Chrome	
Diameter	5.7 mm	6 mm
Max. power	50 W/m	
Voltage	Any voltage on request up to 500 V	
Permissible surface temperature	from - 70°C to + 200°C	
Tolerances	Power : ± 10 % Diameter : + 0.2 / - 0.1 mm Length : ± 1 %	
End insulation	Sealed silicon moulding	
Ingress protection code	IP66	
Minimum bending radius	6 x the diameter	

#### Use

Drain-line heaters are serie resistors. Consult the pages of the catalogue devoted to the corresponding general operating principles, general instructions for use and accessories.

#### FLEXELEC S.A.S

10, rue des frères Lumière  
Z.A. du Bois Rond  
69720 ST BONNET DE MURE - FRANCE  
Tél : + 33 (0)4.72.48.30.90

E-mail : flexelec@omerin.com

#### FLEXELEC Dept

OMERIN ASIA Pte Ltd  
51 Goldhill Plaza #08-11  
SINGAPORE 308900  
Tel : + 65 6255 4778  
Fax : + 65 6255 4779  
E-mail : sales@omerin.com.sg

#### FLEXELEC (UK) Ltd

Unit 11 Kings Park Industrial Estate  
Primrose Hill - KINGS LANGLEY  
Hertfordshire - WD4 8ST - UK  
Tel : + 44 (0) 1923.274477  
Fax : + 44 (0) 1923.270264  
E-mail : sales@omerin.co.uk

#### FLEXELEC Dept

OMERIN GmbH  
Buchwiese 16  
D-65510 IDSTEIN - GERMANY  
Tel : + 49 (0) 6126.94.31-0  
Fax : + 49 (0) 6126.83.999  
E-mail : omeringmbh@omerin.com

## TEMPERATURE MAINTENANCE SYSTEMS

### CSC2

## Silicon elastomer insulated drain-line heaters



### Characteristics

- Fully sealed.
- Double insulation.
- Extremely flexible.
- Voltage 230 V as standard.
- Power cable : Length 1m.
- Special production on request.

### Applications

CSC2 heaters are designed to be laid inside pipes for draining water from thawing refrigeration equipment installed in cold rooms.

They operate only during thawing cycles.

To ensure that these heating elements enjoy a long service life, we recommend using a control device.

Note: The most commonly used power rating is 50 W/m. However, for plastic pipes, we strongly recommend using the 40W/m range.

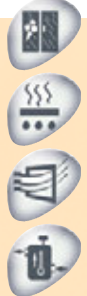

### Standards

CEI 62395-1  
CEI 62395-2



Wire terminated  
in the cold tail

Black mark

Silicon elastomer  
insulation

Silicon elastomer  
insulation

Heating wire

Fiber glass core

Conductor cable

Heating section

Silicon elastomer  
moulding  
9 x 7 mm  
Length 20 mm

### Standard models

Length (m)	CSC2	
	40 W/m	50 W/m
1	40 W	50 W
1.3	52 W	65 W
1.5	60 W	75 W
2	80 W	100 W
3	120 W	150 W
4	160 W	200 W
5	200 W	250 W
6	240 W	300 W

### Caution

These cables must never be cut to shorten the cold tail.

### Use

Drain-line heaters are serie resistors. Consult the pages of the catalogue devoted to the corresponding general operating principles, general instructions for use and accessories.

CSC2	
Heating wire	Nickel-Copper or Nickel-Chrome
Section	5 x 7 mm
Power	40 or 50 W/m
Voltage	Standard 230 V
Permissible surface temperature	from - 70°C to + 200°C
Tolerances	Power : ± 10 % Diameter : + 0.2 / - 0.1 mm Length : ± 1 %
Ingress protection code	IP67
Minimum bending radius	6 x the thickness

#### FLEXELEC S.A.S

10, rue des frères Lumière  
Z.A. du Bois Rond  
69720 ST BONNET DE MURE - FRANCE  
Tél : + 33 (0)4.72.48.30.90

E-mail : [flexelec@omerin.com](mailto:flexelec@omerin.com)

#### FLEXELEC Dept

OMERIN ASIA Pte Ltd  
51 Goldhill Plaza #08-11  
SINGAPORE 308900  
Tel : + 65 6255.4778  
Fax : + 65 6255.4779  
E-mail : [sales@omerin.com.sg](mailto:sales@omerin.com.sg)

#### FLEXELEC (UK) Ltd

Unit 11 Kings Park Industrial Estate  
Primrose Hill - KINGS LANGLEY  
Hertfordshire - WD4 8ST - UK  
Tel : + 44 (0) 1923.274477  
Fax : + 44 (0) 1923.270264  
E-mail : [sales@omerin.co.uk](mailto:sales@omerin.co.uk)

#### FLEXELEC Dept

OMERIN GmbH  
Buchwiese 16  
D-65510 IDSTEIN - GERMANY  
Tel : + 49 (0) 6126.94.31-0  
Fax : + 49 (0) 6126.83.999  
E-mail : [omerinmbh@omerin.com](mailto:omerinmbh@omerin.com)

## TEMPERATURE MAINTENANCE SYSTEMS

### CSC2K

## Silicon elastomer insulated drain-line heaters with integrated thermostat



### Characteristics

- Integrated thermostat.
- Heating section fully sealed.
- Double insulation.
- Extremely flexible.
- Voltage 230 V as standard.
- Power cable length: 1m.as standard
- Special production on request.

### Applications

CSC2K heaters are designed to be placed at the bottom of collector trays inside refrigeration equipment in cold rooms, to prevent freezing and to allow condensate water to flow freely.

The integrated thermostat makes them fully autonomous. It must not be immersed.

Note: The most commonly used power rating is 50 W/m. However, for plastic trays, we strongly recommend using the 40W/m range.



### Standards

CEI 62395-1  
CEI 62395-2

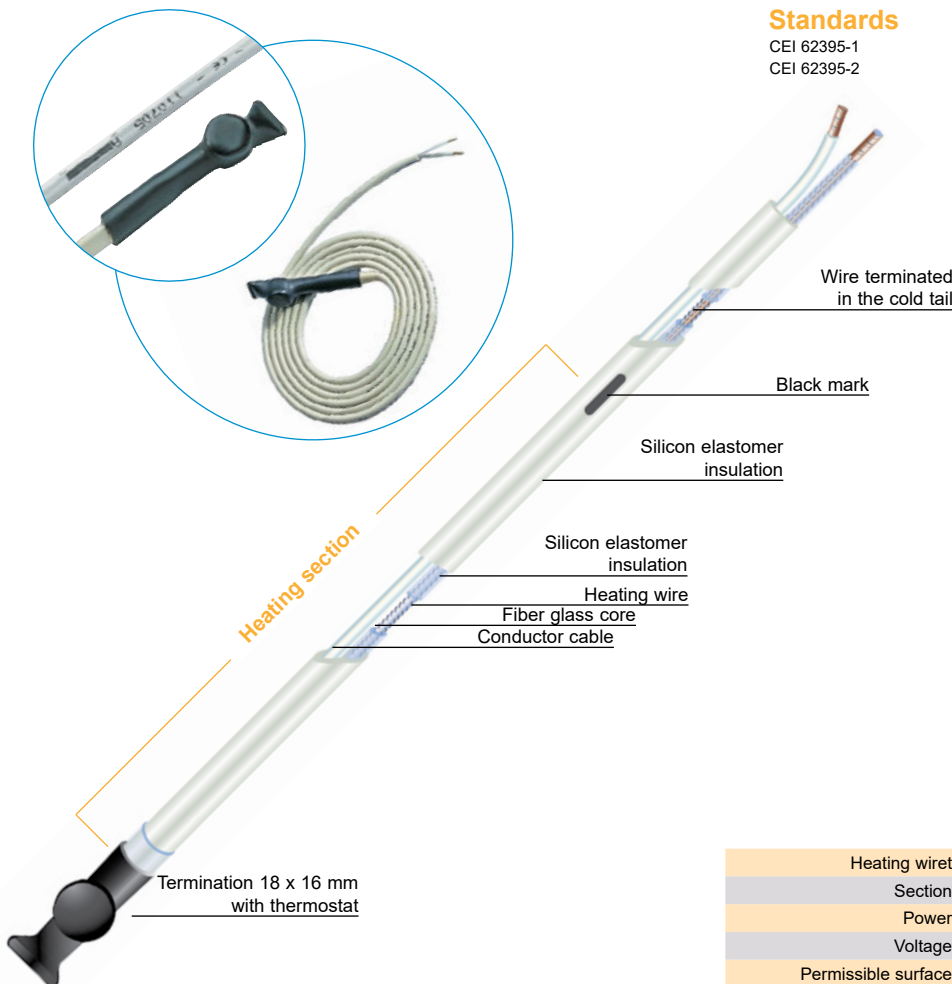

### Standard models

Length (m)	CSC2K	
	40 W/m	50 W/m
1	40 W	50 W
1.3	52 W	65 W
1.5	60 W	75 W
2	80 W	100 W
3	120 W	150 W
4	160 W	200 W
5	200 W	250 W
6	240 W	300 W

CSC2K	
Heating wire	Nickel-Copper or Nickel-Chrome
Section	5 x 7 mm
Power	40 or 50 W/m
Voltage	230 V as standard
Permissible surface temperature	from - 40°C to + 110°C
Tolerances	Power : ± 10 % Diameter : + 0.2 / - 0.1 mm Length : ± 1 %
End insulation	Heat-shrink sheath with adhesive
Thermostat	Pre-set to + 5°C/+ 15°C as standard
Ingress protection code	Cable IP67 - Thermostat IP54
Minimum bending radius	6 x the thickness

### Caution

These cables must never be cut to shorten the cold tail. The round part of the thermostat (sensor) must be placed in the best position to collect information so that the cable can operate as required.

### Use

Drain-line heaters are serie resistors. Consult the pages of the catalogue devoted to the corresponding general operating principles, general instructions for use and accessories.

#### FLEXELEC S.A.S

10, rue des frères Lumière  
Z.A. du Bois Rond  
69720 ST BONNET DE MURE - FRANCE  
Tél : + 33 (0)4.72.48.30.90

E-mail : [flexelec@omerin.com](mailto:flexelec@omerin.com)

#### FLEXELEC Dept

OMERIN ASIA Pte Ltd  
51 Goldhill Plaza #08-11  
SINGAPORE 308900  
Tel : + 65 6255 4778  
Fax : + 65 6255 4779  
E-mail : [sales@omerin.com.sg](mailto:sales@omerin.com.sg)

#### FLEXELEC (UK) Ltd

Unit 11 Kings Park Industrial Estate  
Primrose Hill - KINGS LANGLEY  
Hertfordshire - WD4 8ST - UK  
Tel : + 44 (0) 1923.274477  
Fax : + 44 (0) 1923.270264  
E-mail : [sales@omerin.co.uk](mailto:sales@omerin.co.uk)

#### FLEXELEC Dept

OMERIN GmbH  
Buchwiese 16  
D-65510 IDSTEIN - GERMANY  
Tel : + 49 (0) 6126.94.31-0  
Fax : + 49 (0) 6126.83.999  
E-mail : [omerinmbh@omerin.com](mailto:omerinmbh@omerin.com)

## TEMPERATURE MAINTENANCE SYSTEMS

### CSC2M Silicon elastomer insulated drain-line heaters “micro” size for refrigeration



#### Characteristics

- Fully sealed.
- Double insulation.
- Extremely flexible.
- Voltage 230 V as standard.
- Power cable : length 1m.
- Very small size.
- Round shape.
- Special production on request.

#### Applications

CSC2M heaters are designed to be laid inside pipes for draining water from thawing refrigeration equipment installed in cold rooms.

They operate only during thawing cycles.

To ensure that these heating elements enjoy a long service life, we recommend using a control device.

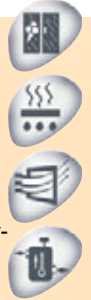

#### Standards

- CEI 62395-1
- CEI 62395-2

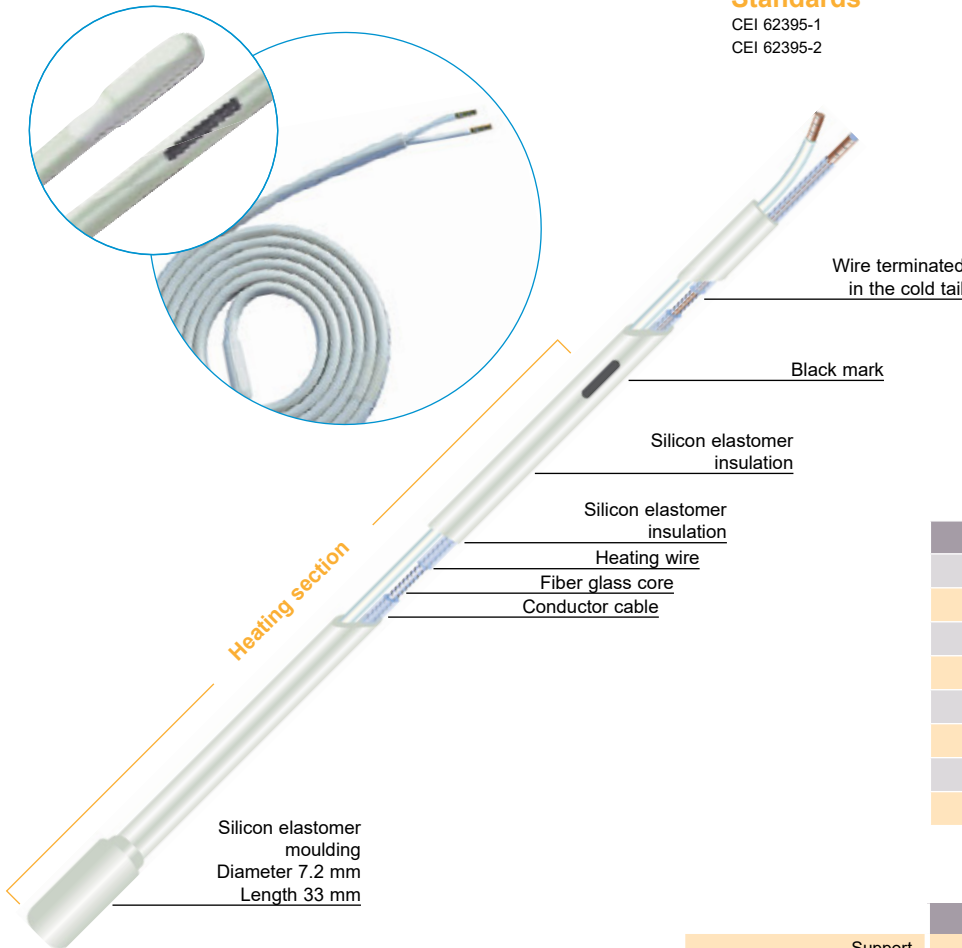

#### Standard models

Length (m)	CSC2M
	40 W/m
1	40 W
1.3	52 W
1.5	60 W
2	80 W
3	120 W
4	160 W
5	200 W
6	240 W

	CSC2M
Support	Nickel-Copper or Nickel-Chrome
Diameter	4.8mm
Power	40 W/m
Voltage	Standard 230 V
Permissible surface temperature	From - 70°C to + 200°C
Tolerances	Power : ± 10 % Diameter : + 0.2 / - 0.1 mm Length : ± 1 %
Ingress protection code	IP67
Minimum bending radius	6 x the diameter

#### Caution

These cables must never be cut to shorten the cold tail.

#### Use

Drain-line heaters are serie resistors. Consult the pages of the catalogue devoted to the corresponding general operating principles, general instructions for use and accessories.

#### FLEXELEC S.A.S

10, rue des frères Lumière  
Z.A. du Bois Rond  
69720 ST BONNET DE MURE - FRANCE  
Tél : + 33 (0)4.72.48.30.90

E-mail : flexelec@omerin.com

#### FLEXELEC Dept

OMERIN ASIA Pte Ltd  
51 Goldhill Plaza #08-11  
SINGAPORE 308900  
Tel : + 65 6255.4778  
Fax : + 65 6255.4779  
E-mail : sales@omerin.com.sg

#### FLEXELEC (UK) Ltd

Unit 11 Kings Park Industrial Estate  
Primrose Hill - KINGS LANGLEY  
Hertfordshire - WD4 8ST - UK  
Tel : + 44 (0) 1923.274477  
Fax : + 44 (0) 1923.270264  
E-mail : sales@omerin.co.uk

#### FLEXELEC Dept

OMERIN GmbH  
Buchwiese 16  
D-65510 IDSTEIN - GERMANY  
Tel : + 49 (0) 6126.94.31-0  
Fax : + 49 (0) 6126.83.999  
E-mail : omeringmbh@omerin.com

# Flexible heating cables and elements temperature maintenance systems



## FLEXTAPE®

### HEATING TAPES

RP - RP/T - RP/I	PVC INSULATED TAPES	39
RS - RS/T - RS/I	SILICON ELASTOMER INSULATED TAPES	40
RSV	ANTI-CONDENSATION TAPES FOR ELECTRIC MOTORS	41
RV/I	FIBRE GLASS INSULATED TAPES	42
RVR	SILICA FIBRE INSULATED TAPES	43

## TEMPERATURE MAINTENANCE SYSTEMS

### RP - RP/T - RP/I PVC insulated tape



#### Characteristics

- Max. power 20 W/m.
- Power cable: length 1m as standard
- RP : PVC insulated heating tape.
- RP/T : with tinned copper braid for earthing and mechanical protection.
- RP/I : with stainless steel braid for earthing and mechanical protection.
- Special production on request.

#### Applications

RP, RP/T and RP/I heating tapes are mainly used to protect piping from freezing, but they can also be used to maintain temperatures up to 60°C.

Insulation is provided by an extremely flexible, high-temperature PVC which makes the tapes easy to use.

To ensure that these heating elements enjoy a long service life, we recommend using a control device.



#### Standards

- CEI 62395-1
- CEI 62395-2

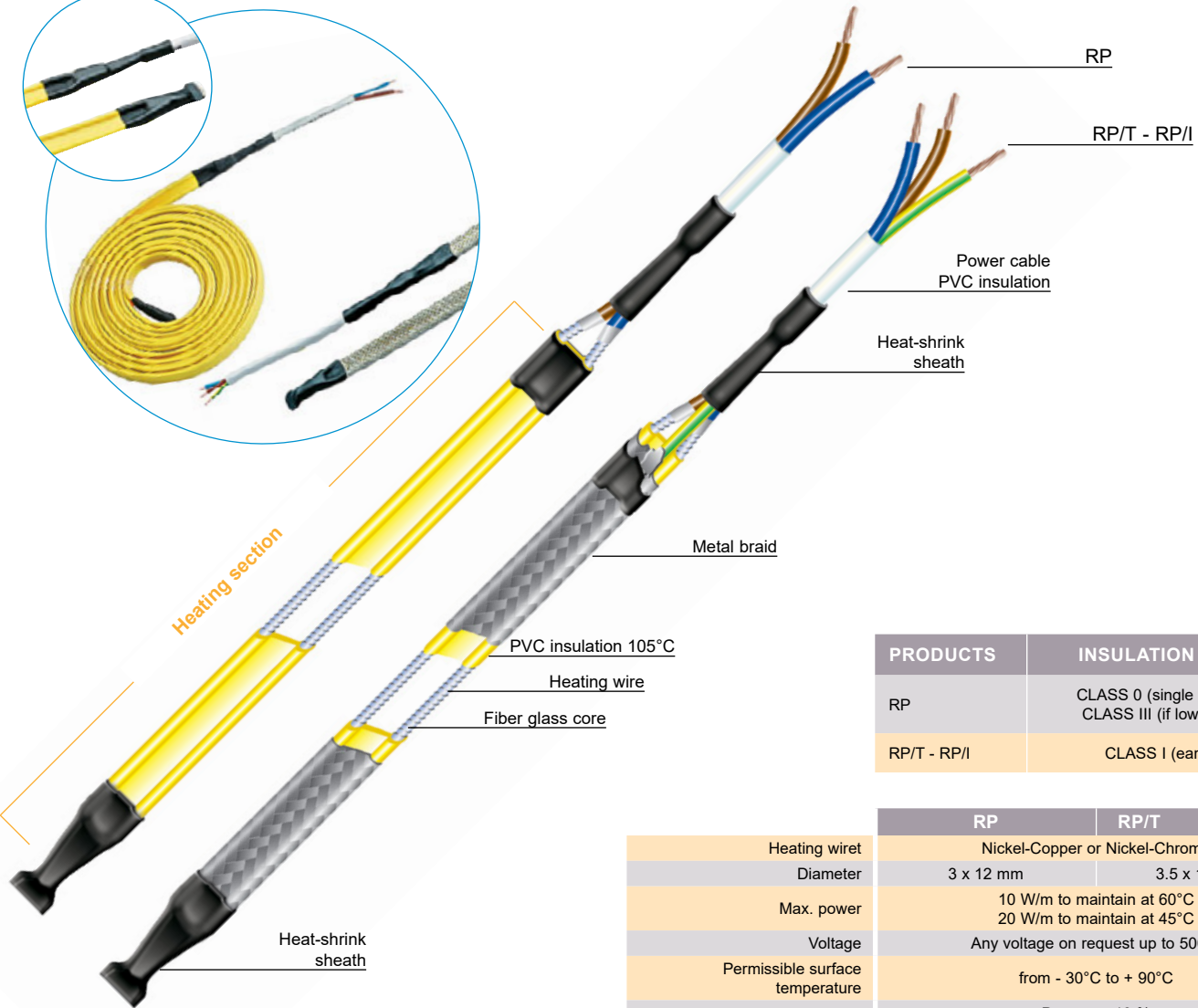

PRODUCTS	INSULATION CLASS
RP	CLASS 0 (single insulated) CLASS III (if low Voltage)
RP/T - RP/I	CLASS I (earthing)

	RP	RP/T	RP/I
Heating wire	Nickel-Copper or Nickel-Chrome		
Diameter	3 x 12 mm		3.5 x 12.5 mm
Max. power	10 W/m to maintain at 60°C 20 W/m to maintain at 45°C		
Voltage	Any voltage on request up to 500 V		
Permissible surface temperature	from - 30°C to + 90°C		
Tolerances	Power : ± 10 % Diameter : + 0.2 / - 0.1 mm Length : ± 1 %		
Connection and end insulation	Heat-shrink sheath with adhesive		
Ingress protection code	IP55		
Minimum bending radius	6 x the thickness		

#### Use

Heating tapes are series resistors. Consult the pages of the catalogue devoted to the corresponding general operating principles, general instructions for use and accessories.

#### FLEXELEC S.A.S

10, rue des frères Lumière  
Z.A. du Bois Rond  
69720 ST BONNET DE MURE - FRANCE  
Tél : + 33 (0)4.72.48.30.90  
E-mail : flexelec@omerin.com

#### FLEXELEC Dept

OMERIN ASIA Pte Ltd  
51 Goldhill Plaza #08-11  
SINGAPORE 308900  
Tel : + 65 6255.4778  
Fax : + 65 6255.4779  
E-mail : sales@omerin.com.sg

#### FLEXELEC (UK) Ltd

Unit 11 Kings Park Industrial Estate  
Primrose Hill - KINGS LANGLEY  
Hertfordshire - WD4 8ST - UK  
Tel : + 44 (0) 1923.274477  
Fax : + 44 (0) 1923.270264  
E-mail : sales@omerin.co.uk

#### FLEXELEC Dept

OMERIN GmbH  
Buchwiese 16  
D-65510 IDSTEIN - GERMANY  
Tel : + 49 (0) 6126.94.31-0  
Fax : + 49 (0) 6126.83.999  
E-mail : omeringmbh@omerin.com



## TEMPERATURE MAINTENANCE SYSTEMS

### RS - RS/T - RS/I Silicon elastomer insulated tape



#### Characteristics

- Max. power 60 W/m.
- Power cable : Length 1m as standard
- RS : silicon elastomer insulated tapes.
- RS/T : with tinned copper braid for earthing and mechanical protection.
- RS/I : with stainless steel braid for earthing and mechanical protection.
- Special production on request.

#### Applications

RS, RS/T and RS/I heating tapes are designed for maintaining temperatures of up to 140°C. They are insulated with a completely sealed silicon elastomer.

To ensure that these heating elements enjoy a long service life, we recommend using a control device.



#### Standards

CEI 62395-1  
CEI 62395-2

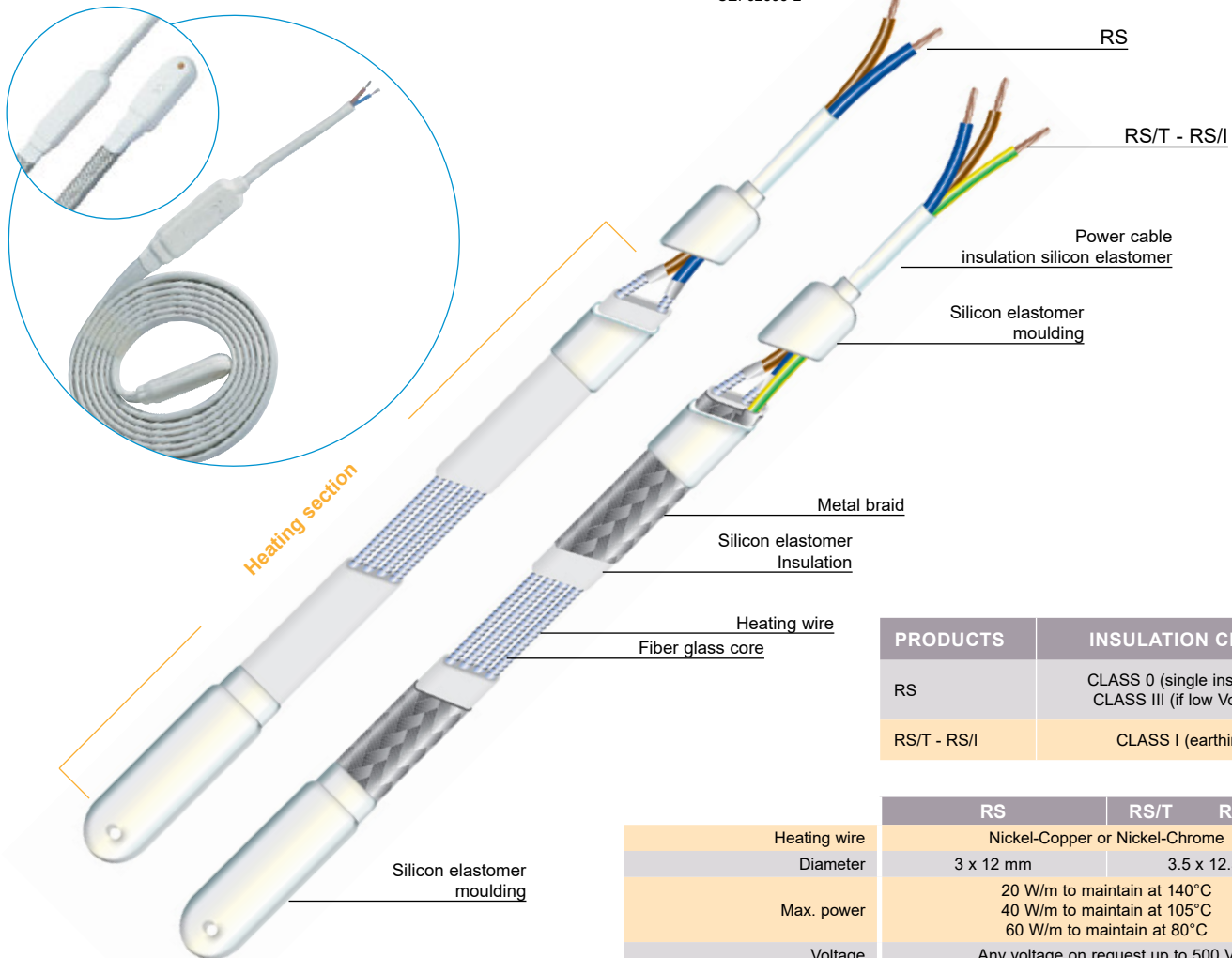

PRODUCTS	INSULATION CLASS
RS	CLASS 0 (single insulated) CLASS III (if low Voltage)
RS/T - RS/I	CLASS I (earthing)

	RS	RS/T	RS/I
Heating wire	Nickel-Copper or Nickel-Chrome		
Diameter	3 x 12 mm		3.5 x 12.5 mm
Max. power	20 W/m to maintain at 140°C 40 W/m to maintain at 105°C 60 W/m to maintain at 80°C		
Voltage	Any voltage on request up to 500 V		
Permissible surface temperature	from - 70°C to + 200°C		
Tolerances	Power : ± 10 % Diameter : + 0.2 / - 0.1 mm Length : ± 1 %		
Connection and end insulation	Sealed silicon elastomer moulding		
Ingress protection code	IP66		
Minimum bending radius	6 x the thickness		

#### Use

Heating tapes are series resistors. Consult the pages of the catalogue devoted to the corresponding general operating principles, general instructions for use and accessories.

#### FLEXELEC S.A.S

10, rue des frères Lumière  
Z.A. du Bois Rond  
69720 ST BONNET DE MURE - FRANCE  
Tél : + 33 (0)4.72.48.30.90

E-mail : [flexelec@omerin.com](mailto:flexelec@omerin.com)

#### FLEXELEC Dept

OMERIN ASIA Pte Ltd  
51 Goldhill Plaza #08-11  
SINGAPORE 308900  
Tel : + 65 6255 4778  
Fax : + 65 6255 4779  
E-mail : [sales@omerin.com.sg](mailto:sales@omerin.com.sg)

#### FLEXELEC (UK) Ltd

Unit 11 Kings Park Industrial Estate  
Primrose Hill - KINGS LANGLEY  
Hertfordshire - WD4 8ST - UK  
Tel : + 44 (0) 1923.274477  
Fax : + 44 (0) 1923.270264  
E-mail : [sales@omerin.co.uk](mailto:sales@omerin.co.uk)

#### FLEXELEC Dept

OMERIN GmbH  
Buchwiese 16  
D-65510 IDSTEIN - GERMANY  
Tel : + 49 (0) 6126.94.31-0  
Fax : + 49 (0) 6126.83.999  
E-mail : [omerinmbh@omerin.com](mailto:omerinmbh@omerin.com)

## TEMPERATURE MAINTENANCE SYSTEMS

### RSV

## Anti-condensation tapes for electric motors



### Characteristics

- Very flexible.
- Maximum heat transfer.
- Damp-proof.
- Extended range of lengths and power ratings.
- Power cable: length 500 mm as standard.
- Voltage 230 V as standard (115 V on request).
- Approved for use in motors running in explosive atmospheres.
- ATEX certificate: Sira N° 02ATEX3410U.
- IECEx certificate: SIR 10.0151U.
- Special production on request.
- Production on request.

### Applications

RSV heating tapes are specially designed for electric motors to prevent condensation.

These elements are ready to be incorporated into the motor coil with their fibre glass braid.

RSV tapes are practical to use and very efficient.

They transfer a maximum amount of heat as they are in direct contact with the stator. RSV tapes are generally energised when the motor stops.

To ensure that these heating elements enjoy a long service life, we recommend using a control device.

### Standards

- |                        |                   |
|------------------------|-------------------|
| CEI 62395-1            | NF EN 60079-30-1  |
| CEI 62395-2            | NF EN 60079-7     |
| CAN/CSA-C22.2 n°130-03 | NF EN IEC 60079-0 |

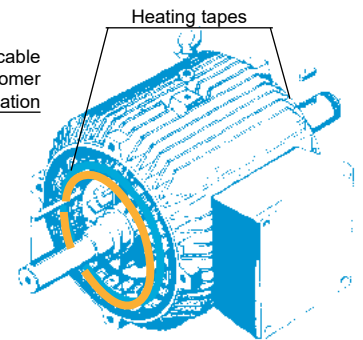
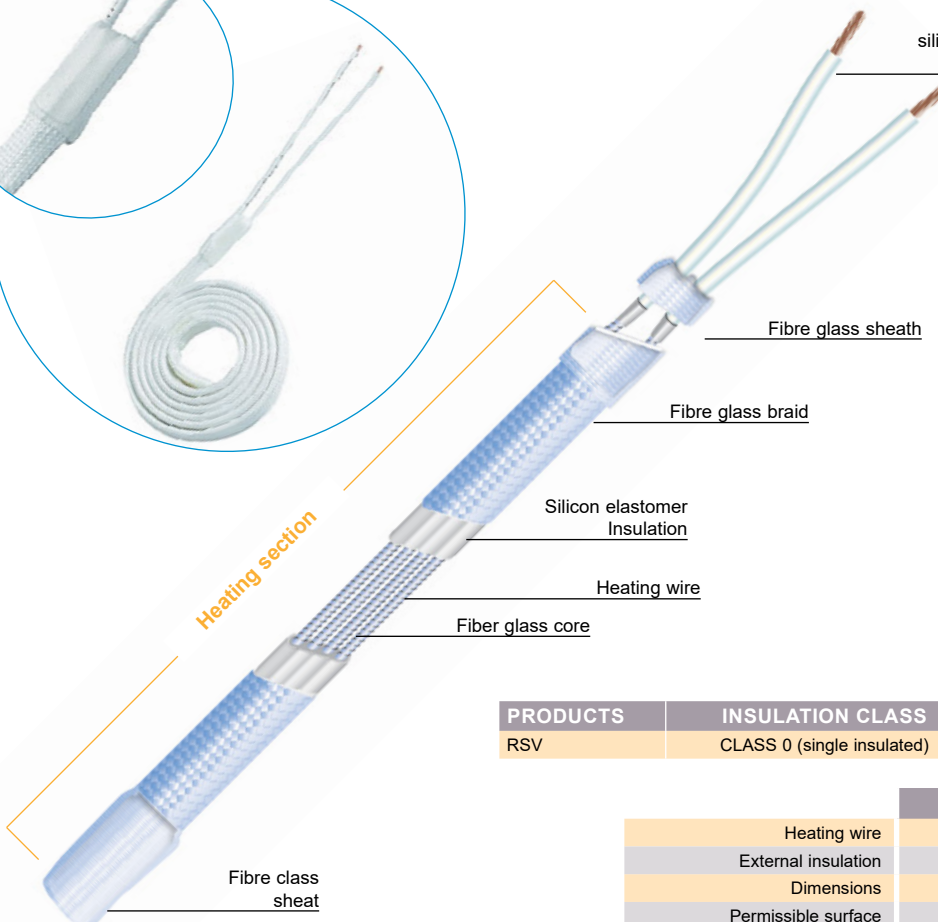

### Standard models

Length (m)	Power (W)
0.30	25
0.43	25
0.68	40
0.79	26
1.01	42
1.06	50
1.47	65
1.70	75
1.70	100
1.85	100

PRODUCTS	INSULATION CLASS
RSV	CLASS 0 (single insulated)

RSV	
Heating wire	Nickel-Copper or Nickel-Chrome
External insulation	Fibre glass braid
Dimensions	3 x 11 mm
Permissible surface temperature	from - 70°C to + 200°C
Tolerances	Power: ± 10 %
Connection and end insulation	Fibre glass sheath
Ingress protection code	IP53
Minimum bending radius	6 x the thickness

### Use

Heating tapes are series resistors. Consult the pages of the catalogue devoted to the corresponding general operating principles, general instructions for use and accessories.

#### FLEXELEC S.A.S

10, rue des frères Lumière  
Z.A. du Bois Rond  
69720 ST BONNET DE MURE - FRANCE  
Tél : + 33 (0)4.72.48.30.90  
E-mail : flexelec@omerin.com

#### FLEXELEC Dept

OMERIN ASIA Pte Ltd  
51 Goldhill Plaza #08-11  
SINGAPORE 308900  
Tel : + 65 6255.4778  
Fax : + 65 6255.4779  
E-mail : sales@omerin.com.sg

#### FLEXELEC (UK) Ltd

Unit 11 Kings Park Industrial Estate  
Primrose Hill - KINGS LANGLEY  
Hertfordshire - WD4 8ST - UK  
Tel : + 44 (0) 1923.274477  
Fax : + 44 (0) 1923.270264  
E-mail : sales@omerin.co.uk

#### FLEXELEC Dept

OMERIN GmbH  
Buchwiese 16  
D-65510 IDSTEIN - GERMANY  
Tel : + 49 (0) 6126.94.31-0  
Fax : + 49 (0) 6126.83.999  
E-mail : omeringmbh@omerin.com

## RV/I Fibre glass insulation tapes



### Characteristics

- Highly flexible.
- Minimum bending radius up to 15 mm.
- High power rating: 250 W/m.
- High temperature: up to + 450°C.
- Not damp-proof
- Voltage 230 V as standard.
- Power cable : Length 500 mm as standard.
- Fibre glass insulation tapes with stainless steel braid for mechanical protection earthing
- Special production on request.

### Applications

RV/I fibre glass tapes are mainly for use in laboratories and industry when it is required to heat quickly to a high temperature. The tapes are very flexible but as they are not damp-proof they can only be used in a dry atmosphere, and in compliance with the electrical protection instructions in force.

To ensure that these heating elements enjoy a long service life, we recommend using a control device.

### Standards

CEI 62395-1  
CEI 62395-2

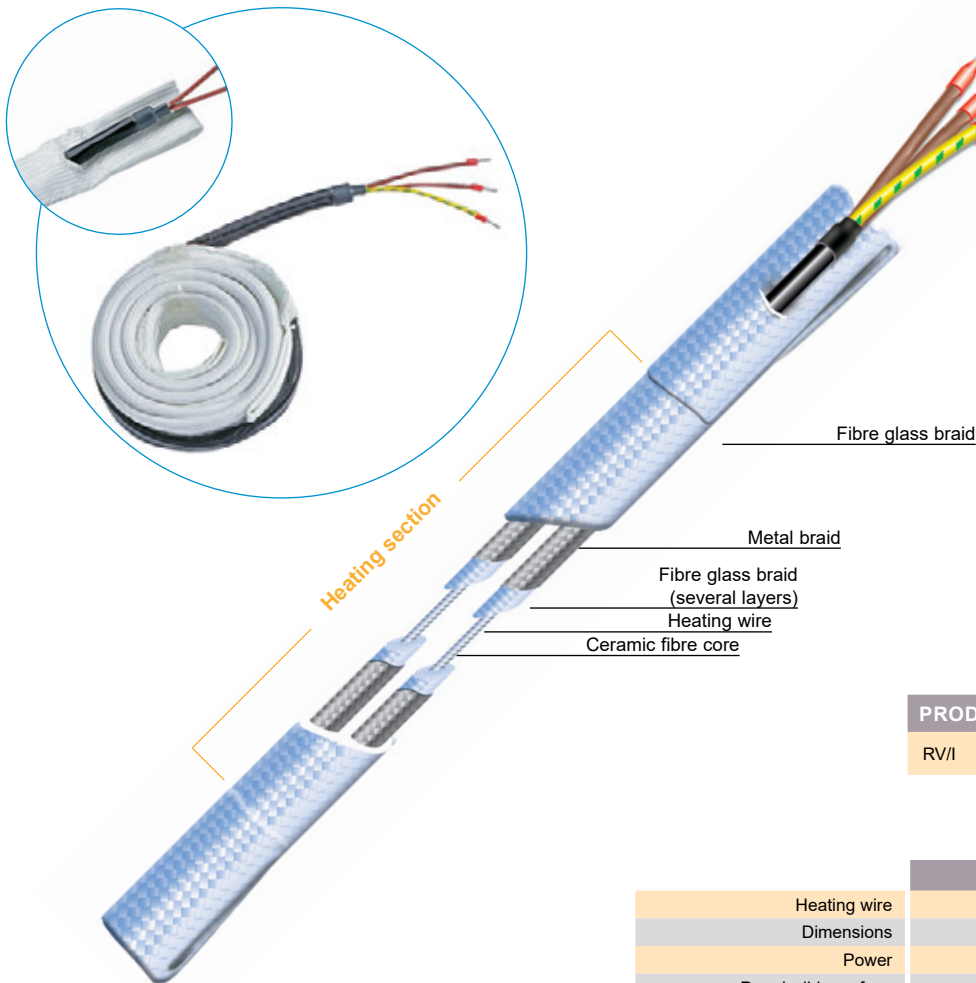

### Standard models

Length (m)	Power (W)
0.5	125
1	250
2	500
3	750
4	1000
5	1250

PRODUCTS	INSULATION CLASS
RV/I	CLASS I (earthing)

	RV/I
Heating wire	Nickel-Copper or Nickel-Chrome
Dimensions	5 x 30 mm
Power	250 W/m
Permissible surface temperature	up to + 450°C
Tolerances	Power: ± 10 %
Ingress protection code	IP40

### Use

Heating tapes are series resistors. Consult the pages of the catalogue devoted to the corresponding general operating principles, general instructions for use and accessories.

#### FLEXELEC S.A.S

10, rue des frères Lumière  
Z.A. du Bois Rond  
69720 ST BONNET DE MURE - FRANCE  
Tél : + 33 (0)4.72.48.30.90

E-mail : flexelec@omerin.com

#### FLEXELEC Dept

OMERIN ASIA Pte Ltd  
51 Goldhill Plaza #08-11  
SINGAPORE 308900  
Tel : + 65 6255 4778  
Fax : + 65 6255 4779  
E-mail : sales@omerin.com.sg

#### FLEXELEC (UK) Ltd

Unit 11 Kings Park Industrial Estate  
Primrose Hill - KINGS LANGLEY  
Hertfordshire - WD4 8ST - UK  
Tel : + 44 (0) 1923.274477  
Fax : + 44 (0) 1923.270264  
E-mail : sales@omerin.co.uk

#### FLEXELEC Dept

OMERIN GmbH  
Buchwiese 16  
D-65510 IDSTEIN - GERMANY  
Tel : + 49 (0) 6126.94.31-0  
Fax : + 49 (0) 6126.83.999  
E-mail : omeringmbh@omerin.com

## TEMPERATURE MAINTENANCE SYSTEMS

### RVR Silica fibre insulated tapes



#### Characteristics

- Highly flexible.
- Very high power rating 350 W/m.
- High temperature, up to + 900°C
- Not damp-proof
- Voltage 230 V as standard.
- Power cable: Length 400 mm as standard.
- Special production on request.

#### Applications

RVR silica fibre tapes are mainly for use in laboratories and in industry if a high concentration of power is necessary or if it is required to work at high temperature, as the "silica fibre" enables the heating element to withstand temperatures of up to 900°C.

These heating tapes are for use only in dry buildings, provided extra electrical protection precautions are taken.

To ensure that these heating elements enjoy a long service life, we recommend using a control device.

#### Standards

CEI 62395-1  
CEI 62395-2

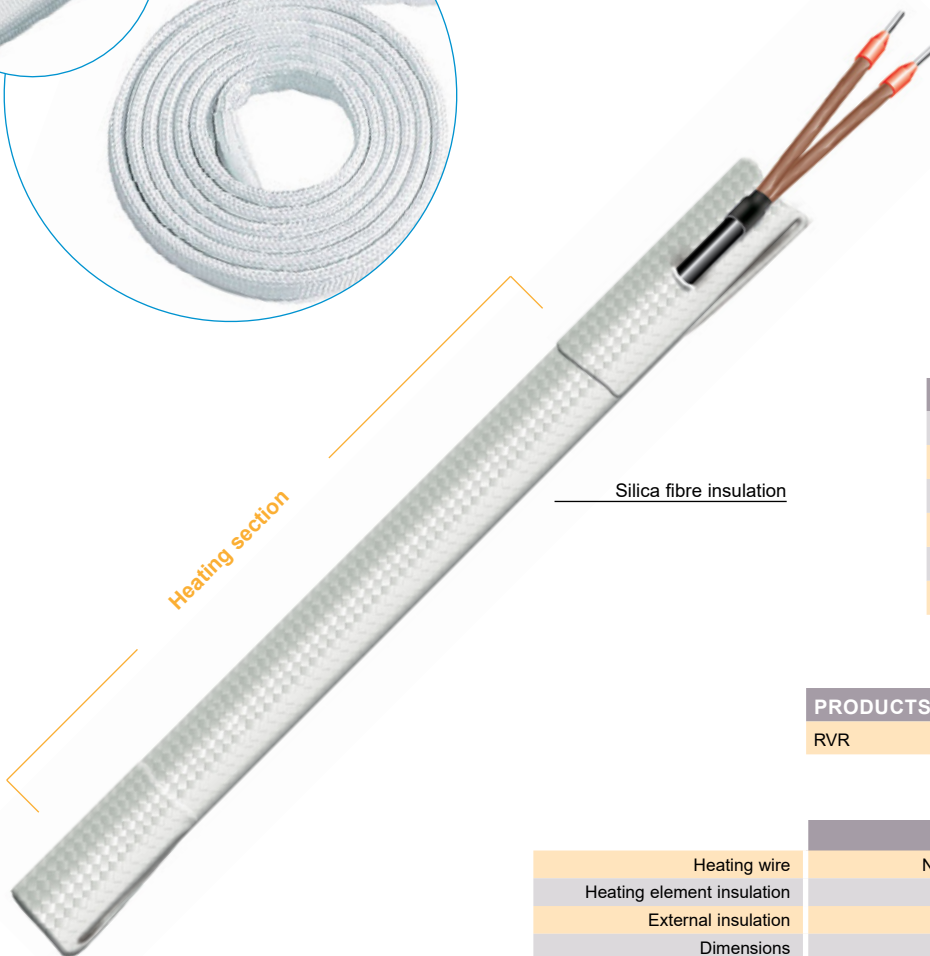

#### Standard models

Length (m)	Power (W)
0.5	175
1	350
1.5	525
2	700
2.5	875
3	1050

PRODUCTS	INSULATION CLASS
RVR	CLASS 0 (single insulated)

#### Use

Heating tapes are series resistors. Consult the pages of the catalogue devoted to the corresponding general operating principles, general instructions for use and accessories.

	RVR
Heating wire	Nickel-Copper or Nickel-Chrome
Heating element insulation	Fibre glass braid
External insulation	Silica fibre
Dimensions	8 x 30 mm
Power	350 W/m
Permissible surface temperature	up to + 900°C
Tolerances	Power: ± 10 %
Ingress protection code	IP40

#### FLEXELEC S.A.S

10, rue des frères Lumière  
Z.A. du Bois Rond  
69720 ST BONNET DE MURE - FRANCE  
Tél : + 33 (0)4.72.48.30.90  
E-mail : flexelec@omerin.com

#### FLEXELEC Dept

OMERIN ASIA Pte Ltd  
51 Goldhill Plaza #08-11  
SINGAPORE 308900  
Tel : + 65 6255.4778  
Fax : + 65 6255.4778  
E-mail : sales@omerin.com.sg

#### FLEXELEC (UK) Ltd

Unit 11 Kings Park Industrial Estate  
Primrose Hill - KINGS LANGLEY  
Hertfordshire - WD4 8ST - UK  
Tel : + 44 (0) 1923.274477  
Fax : + 44 (0) 1923.270264  
E-mail : sales@omerin.co.uk

#### FLEXELEC Dept

OMERIN GmbH  
Buchwiese 16  
D-65510 IDSTEIN - GERMANY  
Tel : + 49 (0) 6126.94.31-0  
Fax : + 49 (0) 6126.83.999  
E-mail : omeringmbh@omerin.com

Flexible heating cables and elements  
temperature maintenance systems



## **STOPGEL® - ANTIFREEZE®**

## STOPGEL - ANTIFREEZE

### Ready-to-use cables

VERITAS certificate  
N° 1563016



### Characteristics

- Voltage 230 V – 50 Hz.
- Double insulation.
- Protection class II.
- Permissible service temperature from - 30°C to + 80°C.
- Complete kit for easy installation.
- Power rating 15 W/m.
- Flat section 5 x 7 mm for better heat transfer.
- 1 meter long power supply at one end only.
- Electrical connection plug included.
- Thermostat incorporated at the end of the cable.
- Fitting accessories supplied.
- 2 years guarantee.
- Special production on request.
- Ingress protection code : IP54

### Applications

STOPGEL - ANTIFREEZE heating cables have been specially designed for protecting metal piping against freezing.

When properly fitted, the heating cables come into operation at + 5°C and will protect your installation against freezing.



### Standards

CEI 62395-2

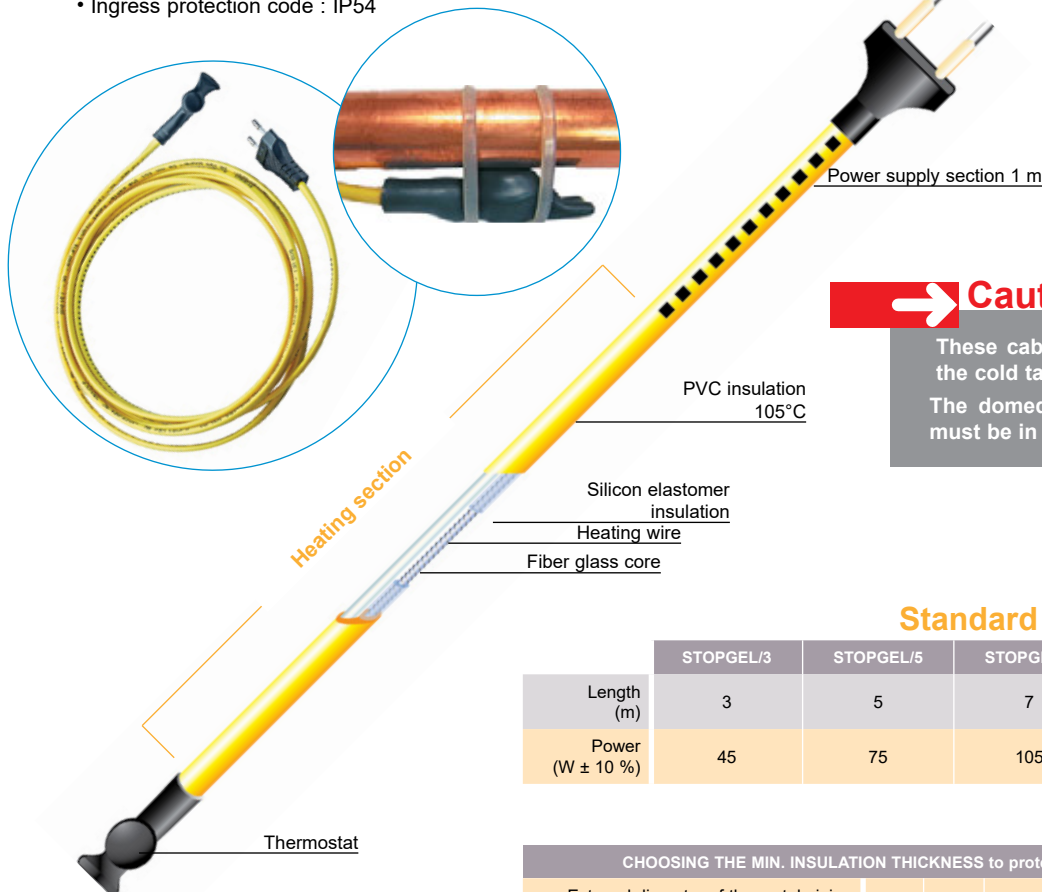

### Caution

These cables must never be cut to shorten the cold tails.

The domed part of the thermostat (sensor) must be in contact with the piping.

### Standard models

	STOPGEL/3	STOPGEL/5	STOPGEL/7	STOPGEL/10	STOPGEL/15
Length (m)	3	5	7	10	15
Power (W ± 10 %)	45	75	105	150	225

CHOOSING THE MIN. INSULATION THICKNESS to protect against freezing down to - 25°C

External diameter of the metal piping (mm)	10	12	16	18	20	24	32	40	48
Thermal insulation thickness (mm)	9	9	9	9	9	9	13	19	19

### Use

STOPGEL - ANTIFREEZE cables are series resistors. Consult the pages of the catalogue devoted to the corresponding general operating principles, general instructions for use and accessories.

#### FLEXELEC S.A.S

10, rue des frères Lumière  
Z.A. du Bois Rond  
69720 ST BONNET DE MURE - FRANCE  
Tél : + 33 (0)4.72.48.30.90

E-mail : flexelec@omerin.com

#### FLEXELEC Dept

OMERIN ASIA Pte Ltd  
51 Goldhill Plaza #08-11  
SINGAPORE 308900  
Tel : + 65 6255.4778  
Fax : + 65 6255.4779  
E-mail : sales@omerin.com.sg

#### FLEXELEC (UK) Ltd

Unit 11 Kings Park Industrial Estate  
Primrose Hill - KINGS LANGLEY  
Hertfordshire - WD4 8ST - UK  
Tel : + 44 (0) 1923.274477  
Fax : + 44 (0) 1923.270264  
E-mail : sales@omerin.co.uk

#### FLEXELEC Dept

OMERIN GmbH  
Buchwiese 16  
D-65510 IDSTEIN - GERMANY  
Tel : + 49 (0) 6126.94.31-0  
Fax : + 49 (0) 6126.83.999  
E-mail : omeringmbh@omerin.com

# Flexible heating cables and elements temperature maintenance systems



## **FLEXTRACE®**

## **ELECTRIC HEAT-TRACING CABLES**

FSH2/TP	SELF-REGULATING CABLES FOR TEMPERATURE MAINTENANCE	47
FSJ - FSJ/T - FSJ/TP	SELF-REGULATING CABLES	48
FSO - FSO/T - FSO/TP	SELF-REGULATING CABLES	49
FST - FST/T - FST/I - FST/TP - FST/TF	SELF-REGULATING CABLES	50
FSX - FSX/T - FSX/I - FSX/TF	SELF-REGULATING CABLES	51
FTC	CONSTANT POWER CABLES FOR GUTTERS	52
FTP - FTP/T - FTP/I - FTP/TP	PVC INSULATED CONSTANT POWER CABLES	53
FTP0 - FTP0/T - FTP0/TP	CONSTANT POWER CABLES FOR REFRIGERATION	54
FTSH - FTSH/T - FTSH/I - FTSH/TS - FTSH/TF	SILICON ELASTOMER INSULATED CONSTANT POWER CABLES	55
FTS0 - FTS0/T - FTS0/TS	SILICON ELASTOMER INSULATED CONSTANT POWER CABLES FOR REFRIGERATION	56
FTSL/TF - FTSL/TS	CONSTANT POWER CABLES WITH SELF LIMITING EFFECT	57
FTSM - FTSM/T	SILICON ELASTOMER INSULATED CONSTANT POWER CABLES FOR REFRIGERATION	58
FTS3/IS - FTS3/IF	HIGH POWER CONSTANT POWER CABLES	59
FTTH - FTTH/T - FTTH/I - FTTH/TF - FTTH/IS	FLUOROPOLYMER INSULATED CONSTANT POWER CABLES	60
FTX1	POLYETHYLENE INSULATED CONSTANT POWER CABLES	61
C1FS/I - C2FS/I - C3FS/I	LONG CABLES AND TAPES	62
C4FS/IS	LONG CABLES AND TAPES	63
SR - SRHT	LONG CABLES AND TAPES	64-65
ZFE/CGE/ATEX - ZFA/CGA/ATEX	ATEX FLUOROPOLYMER INSULATED CONSTANT POWER CABLES	66

## TEMPERATURE MAINTENANCE SYSTEMS



# FSH2/TP Self-regulating cables for temperature maintenance

### Characteristics

- Withstands continuous at + 80°C.
- Can be cut to length on site.
- Will not self-destruct by overheating.
- Available as 40 W/m to + 10°C.
- Power supply 230 V.
- Self-regulating cables, thermoplastic insulation with tinned copper braid and outer thermoplastic anticorrosion sheath.
- Special production on request.

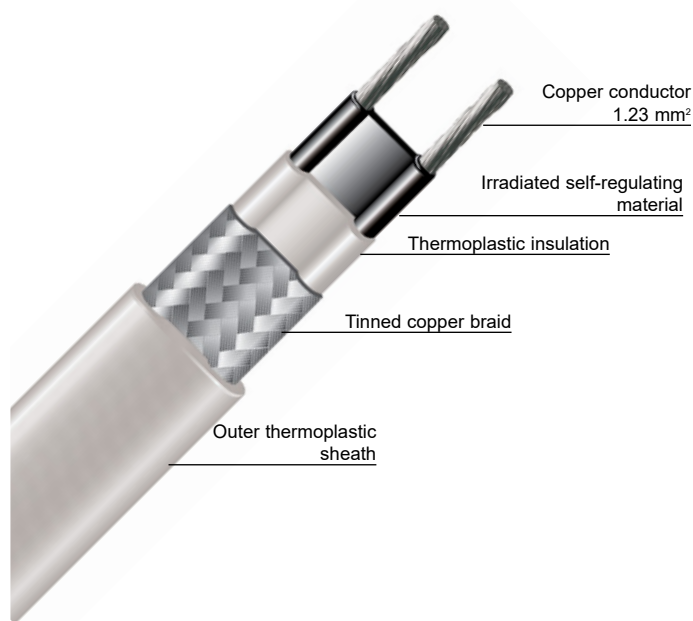
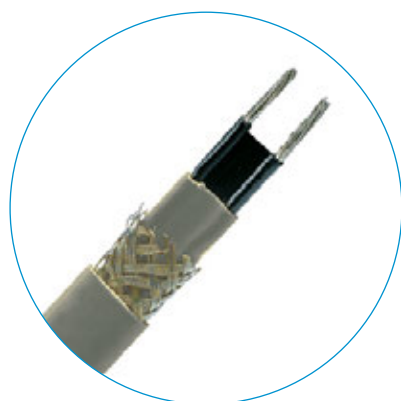

### Applications

This FSH2/TP range of self-regulating heating cables is designed for maintaining the hot water supply at a constant temperature up to +80°C.

By tracing the piping network with an FSH2/TP self-regulating heating cable under the lagging, heat losses are eliminated and the water is kept at the right temperature. Other savings are obtained by doing away with the return piping, pumps, valves, etc.

To ensure that these heating elements enjoy a long service life, we recommend using a control device.

### Standards

- CEI 62395-1
- CEI 62395-2

Power output according to pipe temperature

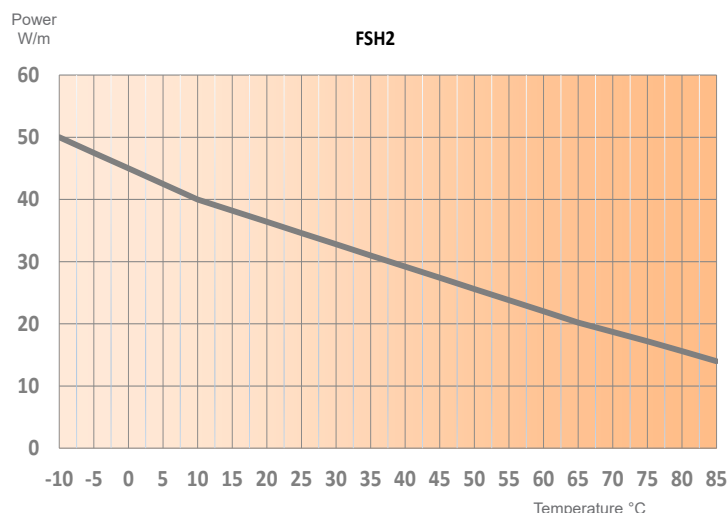

### Use

Consult the pages of the catalogue devoted to the corresponding general operating principles, general instructions for use and accessories.

		FSH2/TP 40
Insulation		Thermoplastic
Dimensions (Tol. +/-0.5mm)		6.8 x 13 mm
Power at 10°C		40 W/m
Permissible surface temperature		Unenergized circuit : max. + 100°C Energized circuit : max. + 80°C
Max. circuit length		
16 A	-10°C	75 m
	0°C	80 m
20 A	-10°C	100 m
	0°C	110 m
Ingress protection code		IP54 with our kits
Min. bending radius		6 x the thickness of cable



## TEMPERATURE MAINTENANCE SYSTEMS

### FSJ - FSJ/T - FSJ/TP Self-regulating cables



#### Characteristics

- Can be cut to length on site.
- Will not self-destruct by overheating.
- Power supply 230 V.
- Available as 15, 25 or 35 W/m at + 10°C.
- FSJ : self-regulating cables thermoplastic insulation.
- FSJ/T : with tinned copper braid for mechanical protection and heating.
- FSJ/TP : with tinned copper braid and outer thermoplastic anticorrosion sheath.
- Special production on request.

#### Applications

Self-regulating cables of the FSJ range are used to protect against freezing or to maintain moderate temperatures.

To ensure that these heating elements enjoy a long service life, we recommend using a control device.



#### Standards

- CEI 62395-1
- CEI 62395-2

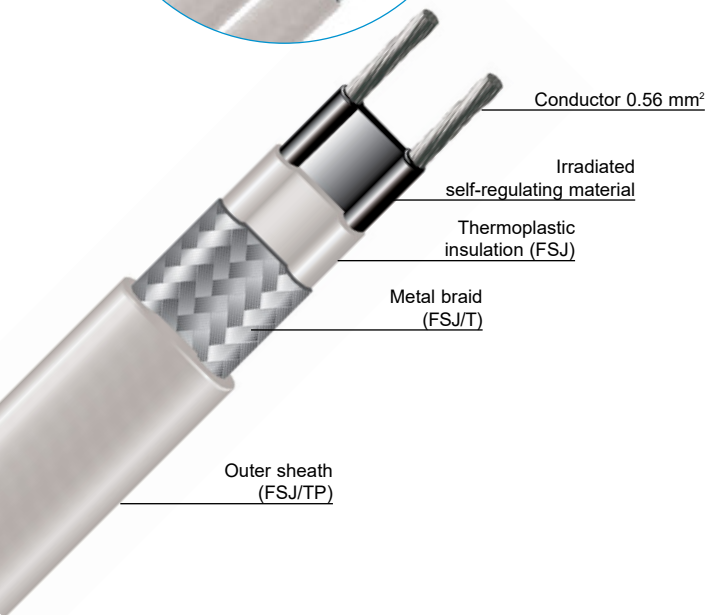
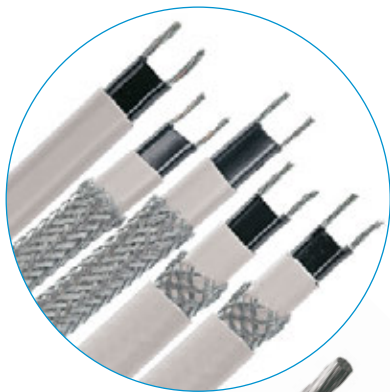

Power output according to pipe temperature

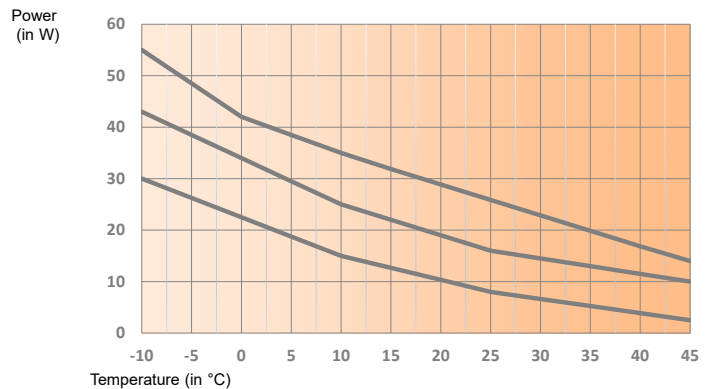

	FSJ 15	FSJ 25	FSJ 35	
Dimensions tolerances +/- 0.3 mm	FSJ : 6 x 3.7 mm			
	FSJ/T : 6.85 x 4.15 mm			
	FSJ/TP : 8.15 x 6.15 mm			
Power at 10°C	15 W/m	25 W/m	35 W/m	
Permissible surface temperature	Unenergized circuit : max. + 65°C Energized circuit : max. + 50°C			
Max. circuit length				
10A	-20°C	80 m	50 m	40 m
	10°C	100 m	70 m	60 m
Ingress protection code	IP54 with our kits			
Min. bending radius	6 x the thickness of cable			

#### Use

Consult the pages of our catalogue devoted to the corresponding general operating principles, general instructions for use and accessories.

## TEMPERATURE MAINTENANCE SYSTEMS

### FSO - FSO/T - FSO/TP Self-regulating cables



#### Characteristics

- Can be cut to length on site.
- Will not self-destruct by overheating.
- Power supply 230 V.
- Available as 10, 20, 30 or 40 W/m at + 10°C.
- FSO : self-regulating cables thermoplastic insulation.
- FSO/T : with tinned copper braid for mechanical protection and heating.
- FSO/TP : with tinned copper braid and outer thermoplastic anticorrosion sheath.
- Special production on request.

#### Applications

Self-regulating cables of the FSO range are used to protect against freezing or to maintain moderate temperatures.

To ensure that these heating elements enjoy a long service life, we recommend using a control device.



#### Standards

- CEI 62395-1
- CEI 62395-2

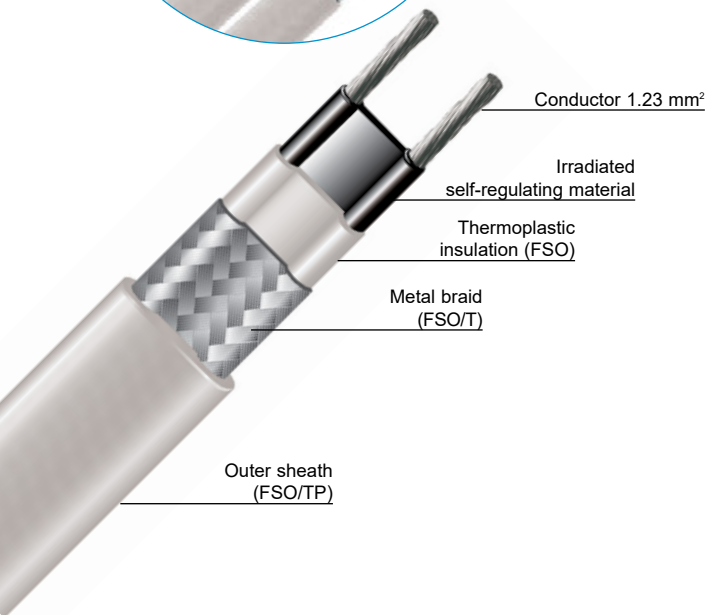

Power output according to pipe temperature

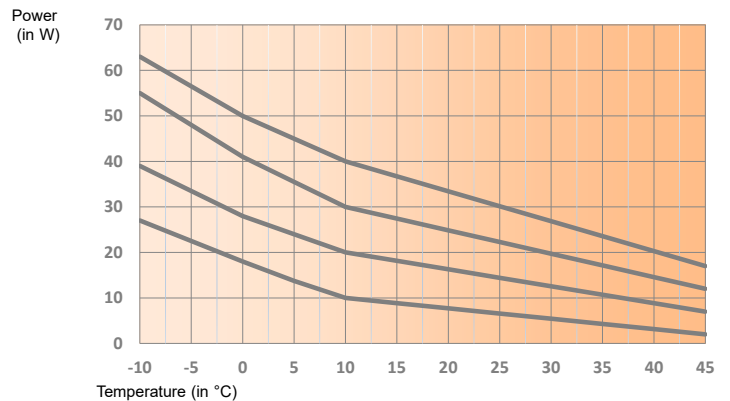

		FSO 10	FSO 20	FSO 30	FSO 40
Dimensions tolerances +/- 0.3 mm		FSO : 9.7 x 3.8 mm			
		FSO/T : 10.65 x 4.35 mm			
		FSO/TP : 12.25 x 6.35 mm			
Power at 10°C		10 W/m	20 W/m	30 W/m	40 W/m
Permissible surface temperature		Unenergized circuit : max. + 65°C			
		Energized circuit : max. + 50°C			
Max. circuit length					
16A	-20°C	180 m	90 m	70 m	50 m
	10°C	200 m	120 m	80 m	70 m
20A	-20°C	230 m	120 m	90 m	65 m
	10°C	230 m	140 m	110 m	80 m
Ingress protection code		IP 54 with our kits			
Min. bending radius		6 x the thickness of cable			

#### Use

Consult the pages of our catalogue devoted to the corresponding general operating principles, general instructions for use and accessories..

#### FLEXELEC S.A.S

10, rue des frères Lumière  
Z.A. du Bois Rond  
69720 ST BONNET DE MURE - FRANCE  
Tél : + 33 (0)4.72.48.30.90  
E-mail : flexelec@omerin.com

#### FLEXELEC Dept

OMERIN ASIA Pte Ltd  
51 Goldhill Plaza #08-11  
SINGAPORE 308900  
Tel : + 65 6255.4778  
Fax : + 65 6255.4779  
E-mail : sales@omerin.com.sg

#### FLEXELEC (UK) Ltd

Unit 11 Kings Park Industrial Estate  
Primrose Hill - KINGS LANGLEY  
Hertfordshire - WD4 8ST - UK  
Tel : + 44 (0) 1923.274477  
Fax : + 44 (0) 1923.270264  
E-mail : sales@omerin.co.uk

#### FLEXELEC Dept

OMERIN GmbH  
Buchwiese 16  
D-65510 IDSTEIN - GERMANY  
Tel : + 49 (0) 6126.94.31-0  
Fax : + 49 (0) 6126.83.999  
E-mail : omeringmbh@omerin.com

## TEMPERATURE MAINTENANCE SYSTEMS

### FST - FST/T - FST/I - FST/TP - FST/TF Self-regulating cables



#### Characteristics

- Can be cut to length on site.
- Will not self-destruct by overheating.
- Power supply 230 V.
- Available as 10, 15, 25, 30 or 40 W/m at + 10°C.
- FST : self-regulating cables thermoplastic insulation.
- FST/T : with tinned copper braid for mechanical protection and earthing.
- FST/I : with stainless steel braid for mechanical protection and earthing.
- FST/TP : with tinned copper braid and outer thermoplastic anticorrosion sheath.
- FST/TF : with tinned copper braid and outer fluoropolymer sheath, ideal for the chemical industry where corrosive products may be present.
- Special production on request.

#### Applications

Self-regulating cables of the FST range are used to protect against freezing or to maintain moderate temperatures.

Cable FST/TP/30 is recommended for protecting against freezing in gutters.

Cables of type FST/TP and FST/TF can, with the appropriate accessories, be used in an explosive atmosphere.

To ensure that these heating elements enjoy a long service life, we recommend using a control device.

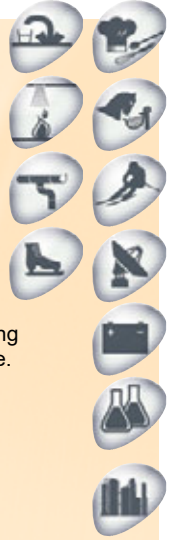

#### Standards

CEI 62395-1  
CEI 62395-2

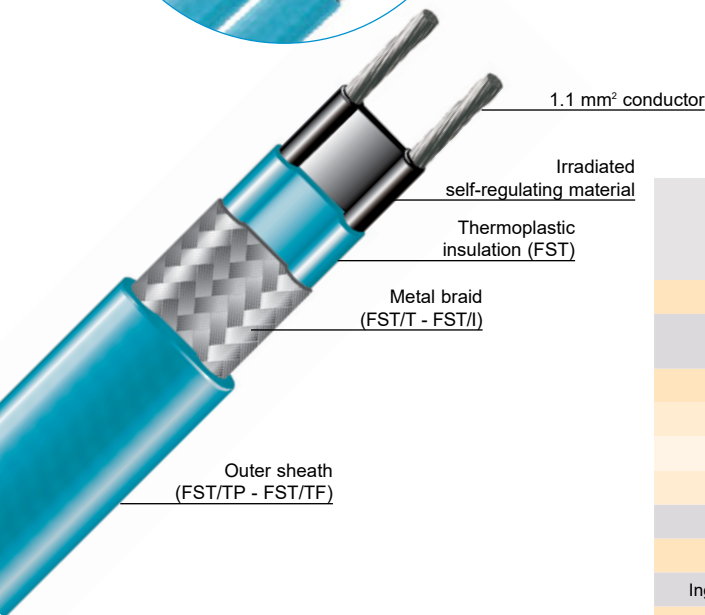

Power output according to pipe temperature

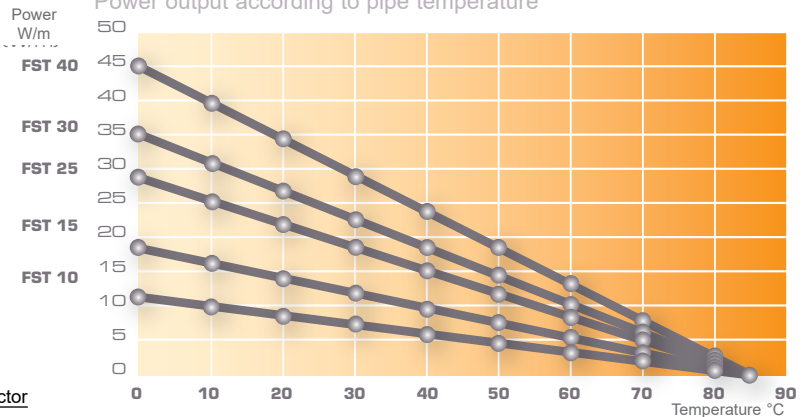

	FST 10	FST 15	FST 25	FST 30	FST 40
Dimensions	FST : 4 x 11 mm FST/T - FST/I : 4.7 x 11.8 mm FST/TP - FST/TF : 6 x 13 mm				
Power at 10°C	10 W/m	17 W/m	25 W/m	31 W/m	40W/m
Permissible surface temperature	Unenergized circuit : max. + 85°C				
Start-up current					
+10°C	0.07 A/m	0.1 A/m	0.13 A/m	0.16 A/m	0.21 A/m
0°C	0.08 A/m	0.12 A/m	0.16 A/m	0.19 A/m	0.26 A/m
- 20°C	0.12 A/m	0.15 A/m	0.21 A/m	0.24 A/m	0.32 A/m
Max. circuit length	198 m	154 m	124 m	110 m	88 m
Temperature class	T6 (85°C)		T4 (135°C)		
Ingress protection code	IP54 with our kits				
Min. bending radius	6 x the thickness of cable				

#### Use

Consult the pages of the catalogue devoted to the corresponding general operating principles, general instructions for use and accessories.

Certificat ATEX : CML 20ATEX3204 pour FST/TP et FST/TF  
Certificat IECEx : CML 20.0130 pour FST/TP et FST/TF

## TEMPERATURE MAINTENANCE SYSTEMS

### FSX - FSX/T - FSX/I - FSX/TF Self-regulating cables



#### Characteristics

- Available as 15, 30, 45, 60 or 75 W/m at + 10°C.
- Can be cut to length on site.
- Will not self-destruct by overheating.
- Power supply 230 V.
- FSX : self-regulating cables, fluoropolymer insulation.
- FSX/T : with tinned copper braid for mechanical protection and earthing.
- FSX/I : with stainless steel braid for mechanical protection and earthing.
- FSX/TF : with tinned copper braid and outer fluoropolymer sheath, ideal for the chemical industry where corrosive substances can be present
- Special production on request.

#### Applications

FSX self-regulating cables are recommended to protect against freezing or to maintain high temperatures.

Cables FSX/TF can, with the appropriate accessories, be used in an explosive atmosphere.

To ensure that these heating elements enjoy a long service life, we recommend using a control device.

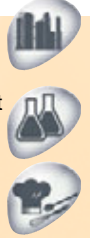

#### Standards

- CEI 62395-1
- CEI 62395-2
- CAN/CSA-C22.2 n°130-03
- NF EN 60079-30-1
- NF EN 60079-7
- NF EN IEC 60079-0

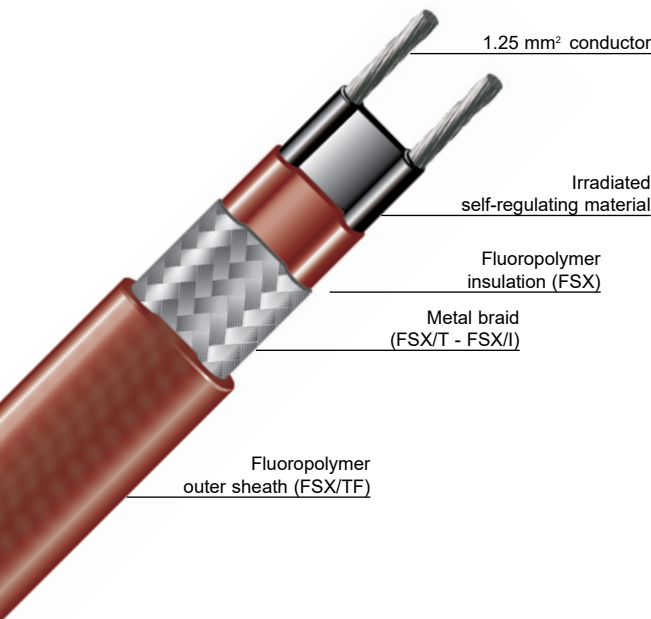
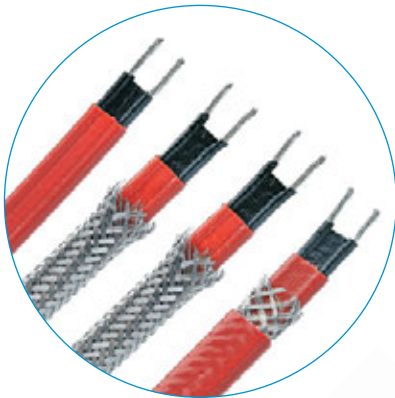

Power output according to pipe temperature

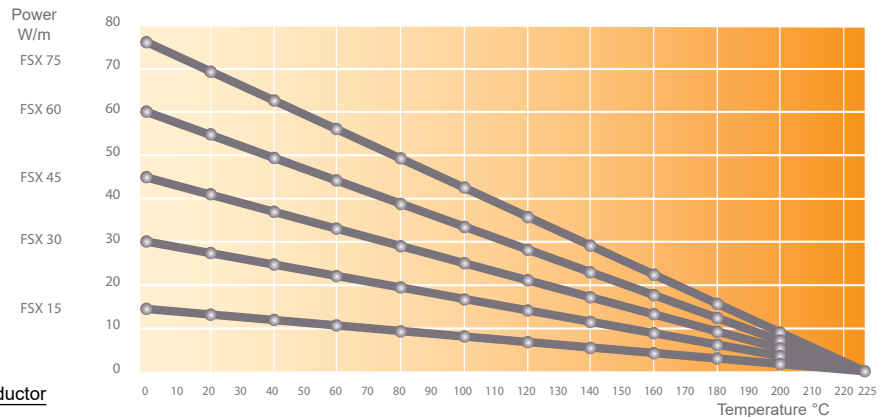

	FSX 15	FSX 30	FSX 45	FSX 60	FSX 75
Dimensions	FSX : 4,5 x 10,5 mm FSX/T - FSX/I : 5 x 11,5 mm FSX/TF : 6 x 13 mm				
Power at 10°C	15 W/m	30 W/m	45 W/m	60 W/m	75 W/m
Permissible surface temperature	Unenergized circuit : + 225°C				
Max. circuit Length	154 m	108 m	88 m	76 m	52 m
Temperature class	T3 (200°C)			T2 (300°C)	
Ingress protection code	IP54 with our kits				
Min. bending radius	6 x the thickness of cable				

#### Use

Consult the pages of the catalogue devoted to the corresponding general operating principles, general instructions for use and accessories.

ATEX certificate: CML 20ATEX3203 pour FSX/TF  
IECEx certificate: CML 20.0129 pour FSX/TF

## TEMPERATURE MAINTENANCE SYSTEMS



### FTC Constant power cables for gutters

#### Characteristics

- Hard-wearing and flexible.
- Can be cut to length on site.
- Extremely simple termination.
- Cold tail incorporated: no extra connection necessary.
- Available as 30 and 40 W/m.
- Power supply 230 V.
- Copper braid and thermoplastic outer sheath to protect against UV rays.
- Special production on request.

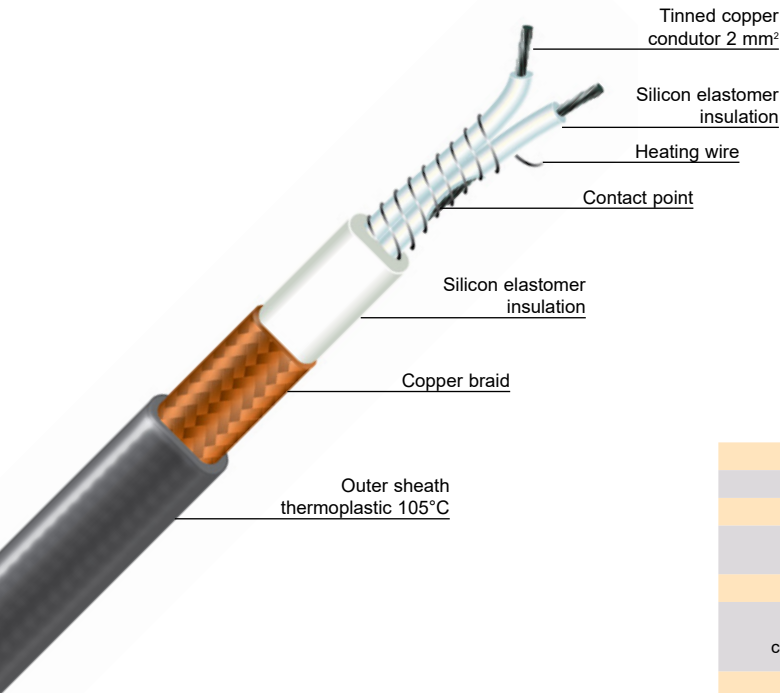

#### Applications

The FTC is a constant power cable designed to protect drainpipes and gutters against freezing.

It also guards against the consequences of two phenomena that occur in winter:

- Gutters obstructed by snowfalls: when snow on the roof melts, water cannot drain away properly and may infiltrate the facades of the building.
- Icicles hanging from gutters can be dangerous when they fall off.

Placed in the bottom of gutters and in drainpipes, the cable maintains a drainage channel for the water and prevents ice from forming.

To ensure that these heating elements enjoy a long service life, we recommend using a control device

#### Standards

- CEI 62395-1
- CEI 62395-2

#### Installation

There are two ways of fitting the cable in the gutter or drainpipe:

- Thoroughly degrease and dry the support and lay the cable, covering it completely with FTAL aluminium adhesive tape.
- Glue the cable into the bottom of the gutter every meter or so using SILT 100 silicon adhesive.

In drainpipes, hold the cable in place with an FX/CRT hook.

Controlling the installation with an FX/CDM2 or FX/CDM3 hygro-thermostat will lead to significant energy savings.

FTC	
Heating wire	Nickel-Copper or Nickel-Chrome
Dimensions	8 x 11 mm
Power	30 or 40 W/m
Permissible surface temperature	From - 30°C to + 90°C
Max. circuit length	120 m in 30 W/m - 100 m in 40 W/m
Distance between 2 consecutive contact points	700 mm
Ingress protection code	IP54 with our kits
Min. bending radius	6 x the thickness of the cable

#### Use

Consult the pages of the catalogue devoted to the corresponding general operating principles, general instructions for use and accessories.

#### FLEXELEC S.A.S

10, rue des frères Lumière  
Z.A. du Bois Rond  
69720 ST BONNET DE MURE - FRANCE  
Tél : + 33 (0)4.72.48.30.90

E-mail : flexelec@omerin.com

#### FLEXELEC Dept

OMERIN ASIA Pte Ltd  
51 Goldhill Plaza #08-11  
SINGAPORE 308900  
Tel : + 65 6255 4778  
Fax : + 65 6255 4779  
E-mail : sales@omerin.com.sg

#### FLEXELEC (UK) Ltd

Unit 11 Kings Park Industrial Estate  
Primrose Hill - KINGS LANGLEY  
Hertfordshire - WD4 8ST - UK  
Tel : + 44 (0) 1923.274477  
Fax : + 44 (0) 1923.270264  
E-mail : sales@omerin.co.uk

#### FLEXELEC Dept

OMERIN GmbH  
Buchwiese 16  
D-65510 IDSTEIN - GERMANY  
Tel : + 49 (0) 6126.94.31-0  
Fax : + 49 (0) 6126.83.999  
E-mail : omeringmbh@omerin.com

## TEMPERATURE MAINTENANCE SYSTEMS



## FTP - FTP/T - FTP/I - FTP/TP PVC insulated constant power cables

### Characteristics

- Hard-wearing and flexible.
- Can be cut to length on site.
- Extremely simple termination.
- Cold tail incorporated: no extra connection necessary.
- Available as 10, 15 and 20 W/m.
- Power supply 230 V as standard (115 V and 400 V on request).
- FTP : PVC insulated constant power cables.
- FTP/T : with tinned copper braid for mechanical protection and earthing.
- FTP/I : with stainless steel braid for mechanical protection and earthing.
- FTP/TP : with copper braid and PVC outer sheath to protect against corrosion.
- Special production on request.

### Applications

FTP cables are particularly suitable for protecting against freezing and maintaining low temperatures. Of constant power cables for industrial use, this PVC insulated version is the most economical.

The FTP 10 (10 W/m) is recommended for plastic piping.

To ensure that these heating elements enjoy a long service life, we recommend using a control device.



### Standards

CEI 62395-1  
CEI 62395-2

Power	Distance between 2 consecutive contact points	Max. circuit length	Max. maintenance temperature
10 W/m	1 m	170 m	60°C
15 W/m	0.8 m	150 m	50°C
20 W/m	0.7 m	140 m	40°C

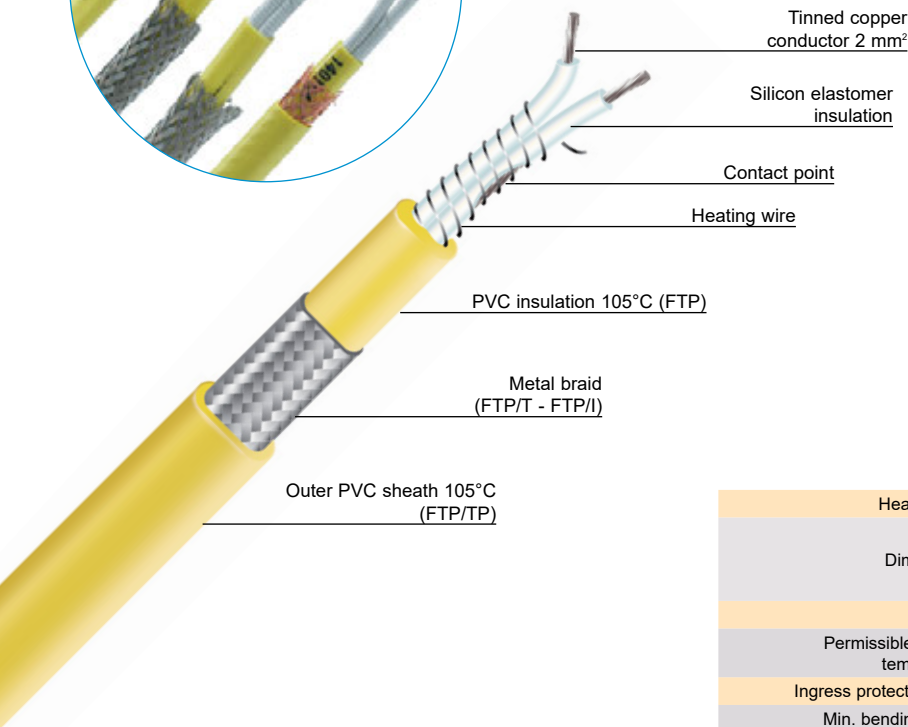

FTP	
Heating wire	Nickel-Copper or Nickel-Chrome
Dimensions	FTP : 5 x 8 mm
	FTP/T - FTP/I : 5.5 x 8.5 mm
	FTP/TP : 7 x 10 mm
Power	10, 15 or 20 W/m
Permissible surface temperature	de - 30°C to + 90°C
Ingress protection code	IP54 with our kits
Min. bending radius	6 x the thickness of cable

### Use

Consult the pages of the catalogue devoted to the corresponding general operating principles, general instructions for use and accessories.

#### FLEXELEC S.A.S

10, rue des frères Lumière  
Z.A. du Bois Rond  
69720 ST BONNET DE MURE - FRANCE  
Tél : + 33 (0)4.72.48.30.90

E-mail : [flexelec@omerin.com](mailto:flexelec@omerin.com)

#### FLEXELEC Dept

OMERIN ASIA Pte Ltd  
51 Goldhill Plaza #08-11  
SINGAPORE 308900  
Tel : + 65 6255.4778  
Fax : + 65 6255.4779  
E-mail : [sales@omerin.com.sg](mailto:sales@omerin.com.sg)

#### FLEXELEC (UK) Ltd

Unit 11 Kings Park Industrial Estate  
Primrose Hill - KINGS LANGLEY  
Hertfordshire - WD4 8ST - UK  
Tel : + 44 (0) 1923.274477  
Fax : + 44 (0) 1923.270264  
E-mail : [sales@omerin.co.uk](mailto:sales@omerin.co.uk)

#### FLEXELEC Dept

OMERIN GmbH  
Buchwiese 16  
D-65510 IDSTEIN - GERMANY  
Tel : + 49 (0) 6126.94.31-0  
Fax : + 49 (0) 6126.83.999  
E-mail : [omerinmbh@omerin.com](mailto:omerinmbh@omerin.com)

## TEMPERATURE MAINTENANCE SYSTEMS



### FTP0 - FTP0/T - FTP0/TP

## PVC insulated constant power cables for refrigeration

### Characteristics

- Can be cut to length on site.
- Extremely simple termination.
- Cold tail incorporated: no extra connection necessary.
- Available as 10 and 15 W/m.
- Power supply 230 V.
- FTP0 : PVC insulated constant power cables.
- FTP0/T : with tinned copper braid for mechanical protection and earthing.
- FTP0/TP : with copper braid and PVC outer sheath to protect against corrosion.
- Special production on request.

### Applications

FTP0 cables are the most economical constant power cables. They are extremely flexible and are designed especially for the refrigeration industry.

FTP0 10 (10 W/m) is recommended for plastic piping.

To ensure that these heating elements enjoy a long service life, we recommend using a control device

### Standards

CEI 62395-1  
CEI 62395-2

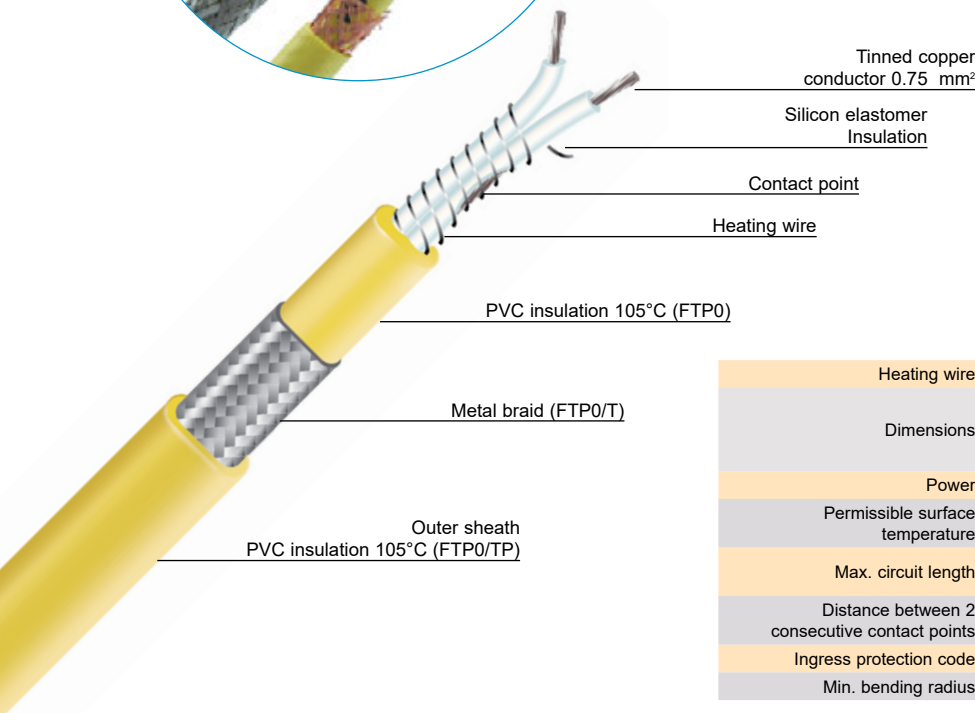
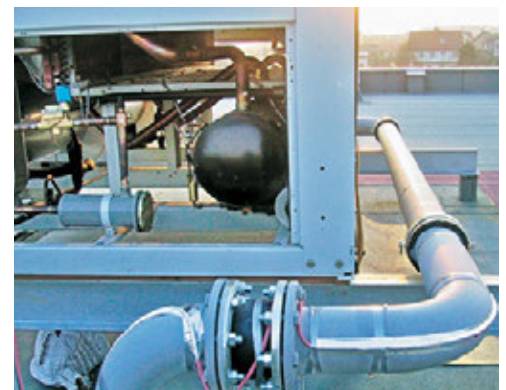

	FTP0
Heating wire	Nickel-Copper or Nickel-Chrome
Dimensions	FTP0 : 5 x 7 mm
	FTP0/T : 5.5 x 7.5 mm
	FTP0/TP : 7 x 9 mm
Power	10 W/m or 15 W/m
Permissible surface temperature	from -30°C to +90°C
Max. circuit length	10 W/m : 120 m
	15 W/m : 80 m
Distance between 2 consecutive contact points	10 W/m : 1 m
	15 W/m : 0.9 m
Ingress protection code	IP54 with our kits
Min. bending radius	6 x the thickness of cable

### Use

Consult the pages of the catalogue devoted to the corresponding general operating principles, general instructions for use and accessories.

#### FLEXELEC S.A.S

10, rue des frères Lumière  
Z.A. du Bois Rond  
69720 ST BONNET DE MURE - FRANCE  
Tél : + 33 (0)4.72.48.30.90

E-mail : [flexelec@omerin.com](mailto:flexelec@omerin.com)

#### FLEXELEC Dept

OMERIN ASIA Pte Ltd  
51 Goldhill Plaza #08-11  
SINGAPORE 308900  
Tel : + 65 6255 4778  
Fax : + 65 6255 4779  
E-mail : [sales@omerin.com.sg](mailto:sales@omerin.com.sg)

#### FLEXELEC (UK) Ltd

Unit 11 Kings Park Industrial Estate  
Primrose Hill - KINGS LANGLEY  
Hertfordshire - WD4 8ST - UK  
Tel : + 44 (0) 1923.274477  
Fax : + 44 (0) 1923.270264  
E-mail : [sales@omerin.co.uk](mailto:sales@omerin.co.uk)

#### FLEXELEC Dept

OMERIN GmbH  
Buchwiese 16  
D-65510 IDSTEIN - GERMANY  
Tel : + 49 (0) 6126.94.31-0  
Fax : + 49 (0) 6126.83.999  
E-mail : [omerinmbh@omerin.com](mailto:omerinmbh@omerin.com)

## TEMPERATURE MAINTENANCE SYSTEMS

### FTSH - FTSH/T - FTSH/I - FTSH/TS - FTSH/TF Silicon elastomer insulated constant power cables



#### Characteristics

- Welded contact points.
- Hard-wearing and flexible.
- Can be cut to length on site.
- Extremely simple termination.
- Cold tail incorporated: no extra connection necessary.
- Available as 20, 30, 40 or 50 W/m.
- Power supply: 230 V as standard (115 V and 400 V on request).
- FTSH : silicon elastomer insulated constant power cables.
- FTSH/T : with tinned copper braid for mechanical protection and earthing.
- FTSH/I : with stainless steel braid for mechanical protection and earthing.
- FTSH/TS : with tinned copper braid and silicon elastomer outer sheath.
- FTSH/TF : with tinned copper braid and fluoropolymer anti-corrosion outer sheath.
- Special production on request.

#### Applications

FTSH cables are particularly suitable for maintaining temperatures of up to + 150°C. Its great flexibility down to - 70°C means that this version is ideal for heat tracing in industrial refrigeration or in countries with very harsh climates. To ensure that these heating elements enjoy a long service life, we recommend using a control device.



#### Standards

- CEI 62395-1
- CEI 62395-2

Power	Distance between 2 consecutive contact points	Max. circuit length	Max. maintenance temperature
20 W/m	0.7 m	140 m	150°C
30 W/m	0.7 m	120 m	140°C
40 W/m	0.6 m	100 m	120°C
50 W/m	0.6 m	80 m	90°C

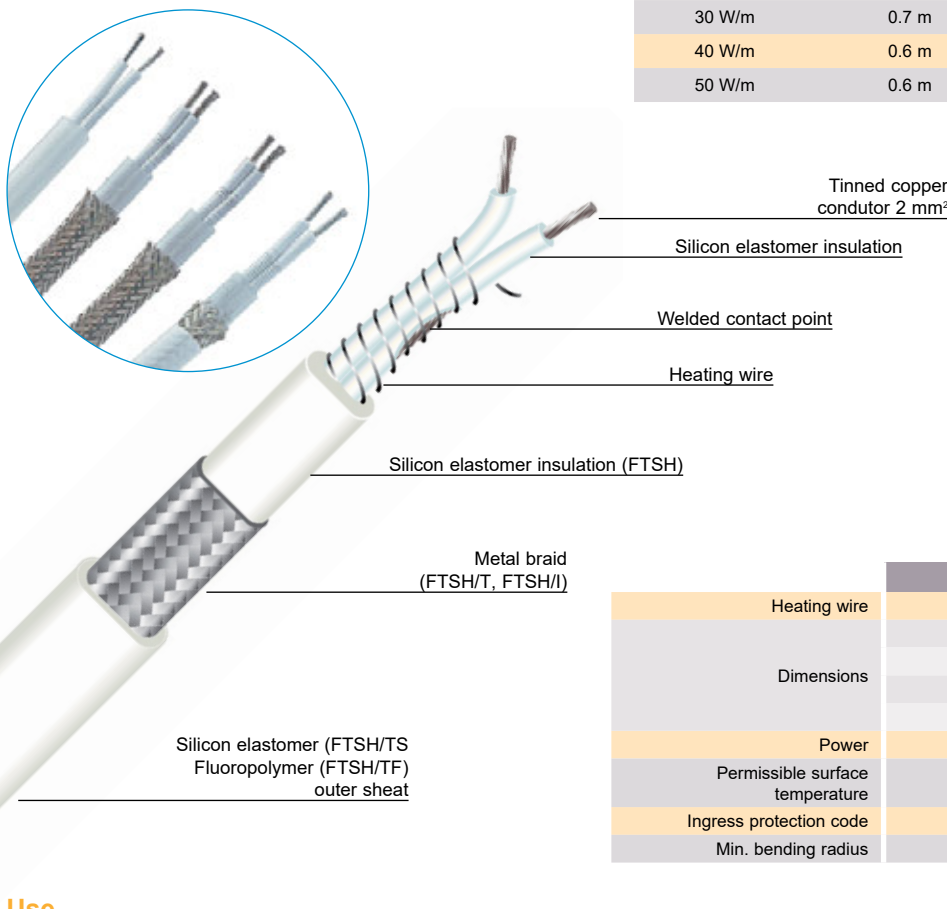

	FTSH
Heating wire	Nickel-Copper or Nickel-Chrome
Dimensions	FTSH : 6 x 10 mm
	FTSH/T - FTSH/I : 6.5 x 10.5 mm
	FTSH/TF : 7 x 10 mm
	FTSH/TS : 8 x 11 mm
Power	20, 30, 40 or 50 W/m
Permissible surface temperature	from - 70°C to + 200°C
Ingress protection code	IP54 with our kits
Min. bending radius	6 x the thickness of cable

#### Use

Consult the pages of the catalogue devoted to the corresponding general operating principles, general instructions for use and accessories.

#### FLEXELEC S.A.S

10, rue des frères Lumière  
Z.A. du Bois Rond  
69720 ST BONNET DE MURE - FRANCE  
Tél : + 33 (0)4.72.48.30.90  
E-mail : flexelec@omerin.com

#### FLEXELEC Dept

OMERIN ASIA Pte Ltd  
51 Goldhill Plaza #08-11  
SINGAPORE 308900  
Tel : + 65 6255.4778  
Fax : + 65 6255.4779  
E-mail : sales@omerin.com.sg

#### FLEXELEC (UK) Ltd

Unit 11 Kings Park Industrial Estate  
Primrose Hill - KINGS LANGLEY  
Hertfordshire - WD4 8ST - UK  
Tel : + 44 (0) 1923.274477  
Fax : + 44 (0) 1923.270264  
E-mail : sales@omerin.co.uk

#### FLEXELEC Dept

OMERIN GmbH  
Buchwiese 16  
D-65510 IDSTEIN - GERMANY  
Tel : + 49 (0) 6126.94.31-0  
Fax : + 49 (0) 6126.83.999  
E-mail : omeringmbh@omerin.com



## TEMPERATURE MAINTENANCE SYSTEMS

### FTS0 - FTS0/T - FTS0/TS

## Silicon elastomer insulated constant power cables for refrigeration



### Characteristics

- Can be cut to length on site.
- Extremely simple termination.
- Cold tail incorporated: no extra connection necessary.
- Available as 25, 40 or 50 W/m.
- Power supply: 230 V (24 V and 115 V on request).
- FTS0 : silicon elastomer insulated constant power cables.
- FTS0/T : with tinned copper braid for mechanical protection and earthing.
- FTS0/TS : with tinned copper braid and silicon elastomer insulated outer sheath.
- Special production on request.

### Applications

FTS0 cables are designed for use in industrial refrigeration. Their great flexibility means that they can be incorporated into cold room doors. They must not be used for temperature maintenance. To ensure that these heating elements enjoy a long service life, we recommend using a control device.



### Standards

CEI 62395-1  
CEI 62395-2

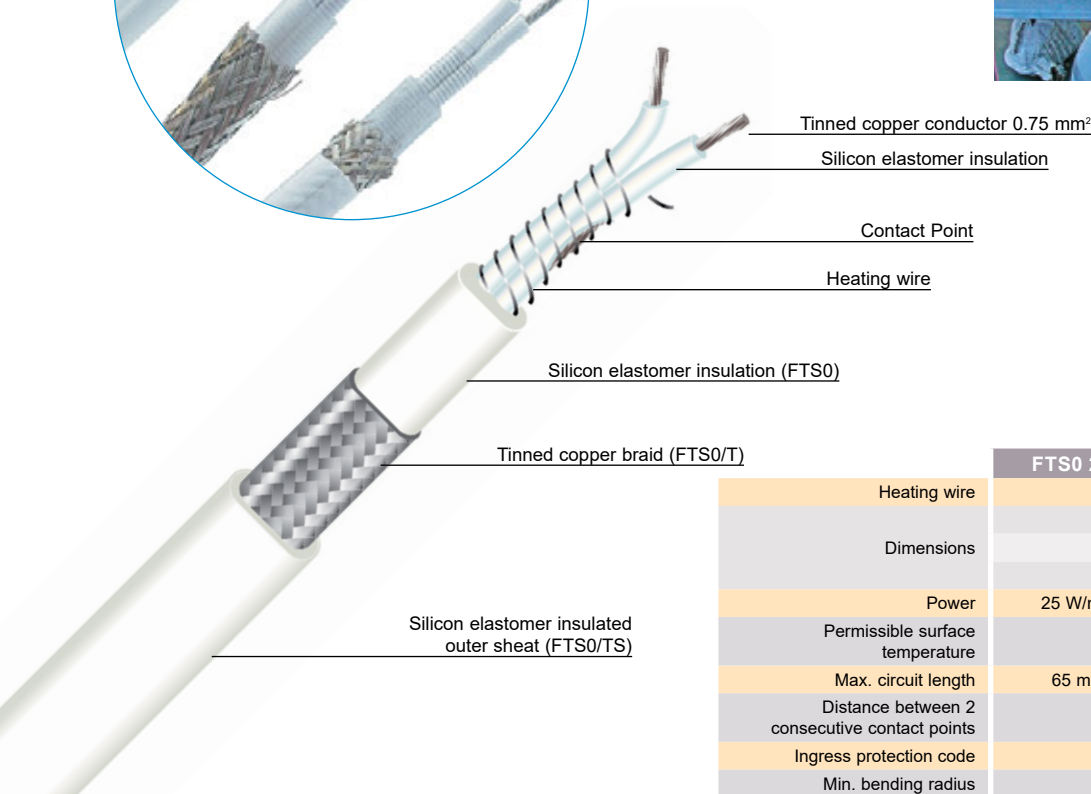
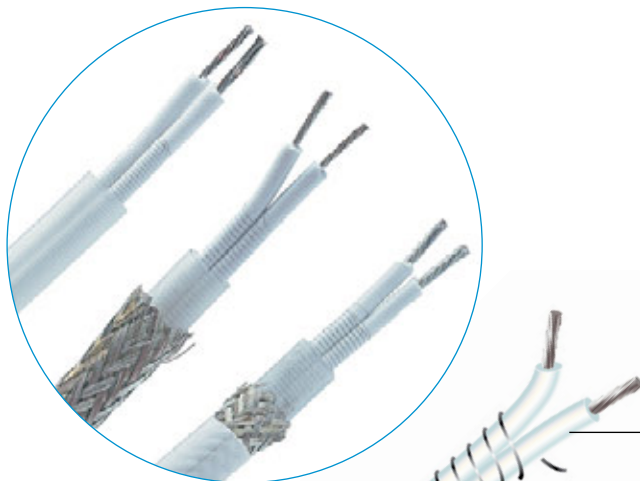

	FTS0 25	FTS0 40	FTS0 50
Heating wire	Nickel-Copper or Nickel-Chrome		
Dimensions	FTS0 : 5 x 7 mm		
	FTS0/T : 5.5 x 7.5 mm		
	FTS0/TS : 7.5 x 9.5 mm		
Power	25 W/m	40 W/m	50 W/m
Permissible surface temperature	from - 70°C to + 200°C		
Max. circuit length	65 m	50 m	44 m
Distance between 2 consecutive contact points	0.5 m		
Ingress protection code	IP54 with our kits		
Min. bending radius	6 x the thickness of cable		

### Use

Consult the pages of the catalogue devoted to the corresponding general operating principles, general instructions for use and accessories.

## TEMPERATURE MAINTENANCE SYSTEMS



# FTSL/TF - FTSL/TS Constant power cable with self-limiting effect

### Characteristics

- Welded contact points.
- Hard-wearing and flexible.
- Can be cut to length on site.
- Extremely simple termination.
- Cold tail incorporated: no extra connection necessary.
- Available as 55, 75, 95 or 115 W/m at +20°C.
- Power supply 230 V and 400 V as standard.
- FTSL/TS : with tinned copper braid and silicon elastomer outer sheath.
- FTSL/TF : with tinned copper braid and fluoropolymer anti-corrosion outer sheath.
- Special production on request.

### Applications

FTSL cables are particularly suitable for maintaining temperatures of up to + 135°C.

Its great flexibility up to - 70°C means that this version is ideal for heat tracing.

To ensure that these heating elements enjoy a long service life, we recommend using a control device.



### Standards

- CEI 62395-1
- CEI 62395-2

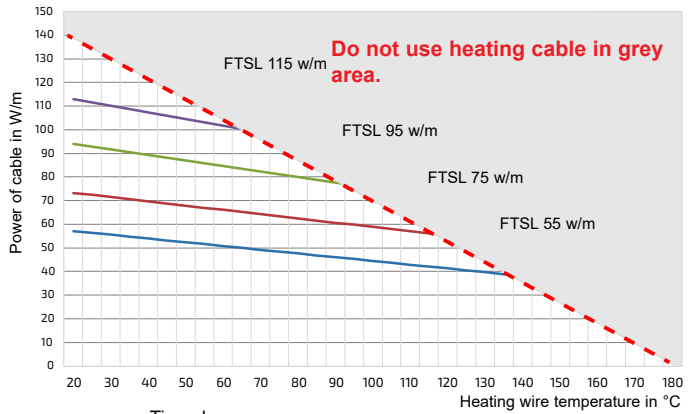
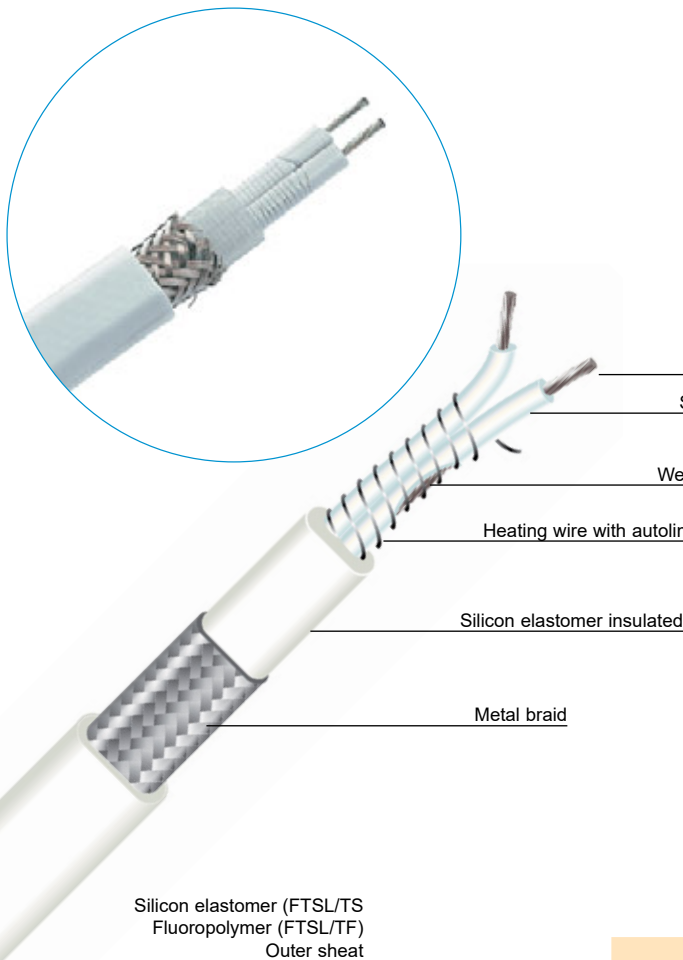

The curve above presents the power in w/m in comparison to the heating wire temperature. The heating cable must be covered 100% with an adhesive aluminium and installed on a metallic support. Consult our technical department for any informations.

FTSL Power at +20°C	Distance between 2 consecutive contact points 230 V version	Distance between 2 consecutive contact points 400 V version	Max. maintenance temperature	Max. circuit length under 230V at +20°C
55 W/m	2.0 m	2.75 m	135°C	54 m
75 W/m	1.6 m	2.75 m	115°C	46 m
95 W/m	1.4 m	2.0 m	90°C	41 m
115 W/m	1.0 m	1.5 m	60°C	37 m

	FTSL
Heating wire	Nickel
Dimensions	FTSL/TF : 8.4 x 11.9 mm
	FTSL/TS : 8.6 x 12.2 mm
Permissible surface temperature	from - 70°C to + 200°C
Ingress protection code	IP54 with our kits
Min. bending radius	6 x the thickness of cable

### Use

Consult the pages of the catalogue devoted to the corresponding general operating principles, general instructions for use and accessories.

#### FLEXELEC S.A.S

10, rue des frères Lumière  
Z.A. du Bois Rond  
69720 ST BONNET DE MURE - FRANCE  
Tél : + 33 (0)4.72.48.30.90

E-mail : flexelec@omerin.com

#### FLEXELEC Dept

OMERIN ASIA Pte Ltd  
51 Goldhill Plaza #08-11  
SINGAPORE 308900  
Tel : + 65 6255.4778  
Fax : + 65 6255.4779  
E-mail : sales@omerin.com.sg

#### FLEXELEC (UK) Ltd

Unit 11 Kings Park Industrial Estate  
Primrose Hill - KINGS LANGLEY  
Hertfordshire - WD4 8ST - UK  
Tel : + 44 (0) 1923.274477  
Fax : + 44 (0) 1923.270264  
E-mail : sales@omerin.co.uk

#### FLEXELEC Dept

OMERIN GmbH  
Buchwiese 16  
D-65510 IDSTEIN - GERMANY  
Tel : + 49 (0) 6126.94.31-0  
Fax : + 49 (0) 6126.83.999  
E-mail : omeringmbh@omerin.com

## TEMPERATURE MAINTENANCE SYSTEMS

### FTSM - FTSM/T Silicon elastomer insulated constant power cable "micro"size for refrigeration



#### Characteristics

- Very small diameter.
- Round shape.
- High flexibility
- Can be cut to length on site..
- Extremely simple termination.
- Cold tail incorporated: no extra connection necessary.
- Available as 10, 20, 30 et 40 W/m (others on request).
- Power supply: 230 V as standard (others on request).
- FTSM : silicon elastomer insulated constant power cable
- FTSM/T : with tinned copper braid for mechanical protection and earthing.

#### Applications

FTSM cables are particularly suitable for applications in the refrigeration industry.

Its very small dimensions as well as its great flexibility down to -70°C means that this version is ideal for freeze protection and door frame heating in the refrigeration sector.

They must not be used for temperature maintenance.

To ensure that these heating elements enjoy a long service life, we recommend using a control device.



#### Standards

- CEI 62395-1
- CEI 62395-2

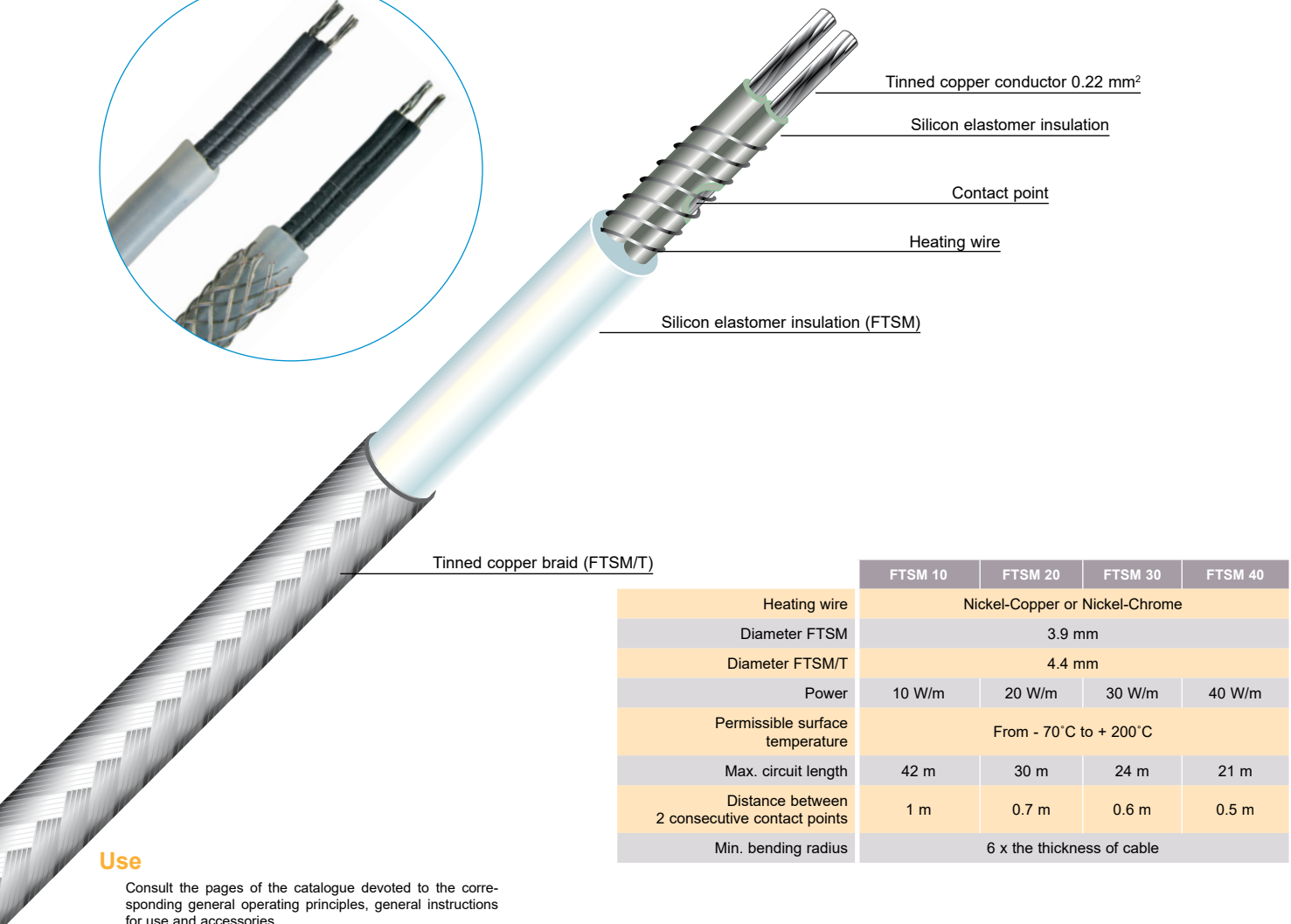

	FTSM 10	FTSM 20	FTSM 30	FTSM 40
Heating wire	Nickel-Copper or Nickel-Chrome			
Diameter FTSM	3.9 mm			
Diameter FTSM/T	4.4 mm			
Power	10 W/m	20 W/m	30 W/m	40 W/m
Permissible surface temperature	From - 70°C to + 200°C			
Max. circuit length	42 m	30 m	24 m	21 m
Distance between 2 consecutive contact points	1 m	0.7 m	0.6 m	0.5 m
Min. bending radius	6 x the thickness of cable			

#### Use

Consult the pages of the catalogue devoted to the corresponding general operating principles, general instructions for use and accessories.

#### FLEXELEC S.A.S

10, rue des frères Lumière  
Z.A. du Bois Rond  
69720 ST BONNET DE MURE - FRANCE  
Tél : + 33 (0)4.72.48.30.90

E-mail : flexelec@omerin.com

#### FLEXELEC Dept

OMERIN ASIA Pte Ltd  
51 Goldhill Plaza #08-11  
SINGAPORE 308900  
Tel : + 65 6255.4778  
Fax : + 65 6255.4779  
E-mail : sales@omerin.com.sg

#### FLEXELEC (UK) Ltd

Unit 11 Kings Park Industrial Estate  
Primrose Hill - KINGS LANGLEY  
Hertfordshire - WD4 8ST - UK  
Tel : + 44 (0) 1923.274477  
Fax : + 44 (0) 1923.270264  
E-mail : sales@omerin.co.uk

#### FLEXELEC Dept

OMERIN GmbH  
Buchwiese 16  
D-65510 IDSTEIN - GERMANY  
Tel : + 49 (0) 6126.94.31-0  
Fax : + 49 (0) 6126.83.999  
E-mail : omeringmbh@omerin.com

## TEMPERATURE MAINTENANCE SYSTEMS

### FTS3/IS - FTS3/IF High power constant power cables



#### Characteristics

- Welded contact points.
- Can be cut to length on site.
- Extremely simple termination.
- Cold tail incorporated: no extra connection necessary.
- Available as 100 W/m.
- Power supply 230 V or 400 V (option 750 V)
- FTS3/IS : Stainless steel braid and silicon elastomer outer sheath.
- FTS3/IF : Stainless steel braid and fluoropolymer outer sheath.
- Special production on request.

#### Applications

FTS3/IS and FTS3/IF cables are designed for protecting railway lines, points and power rails from freezing or for keeping them clear of snow.

To ensure that these heating elements enjoy a long service life, we recommend using a control device.



#### Standards

CEI 62395-1                      NF EN 60077-1  
CEI 62395-2                      NF EN 60077-2

#### Fitting :

As a fitting accessory, we offer a U-shaped composite profile to cover the cable. Section 10 x 24 mm - Length 3 m.

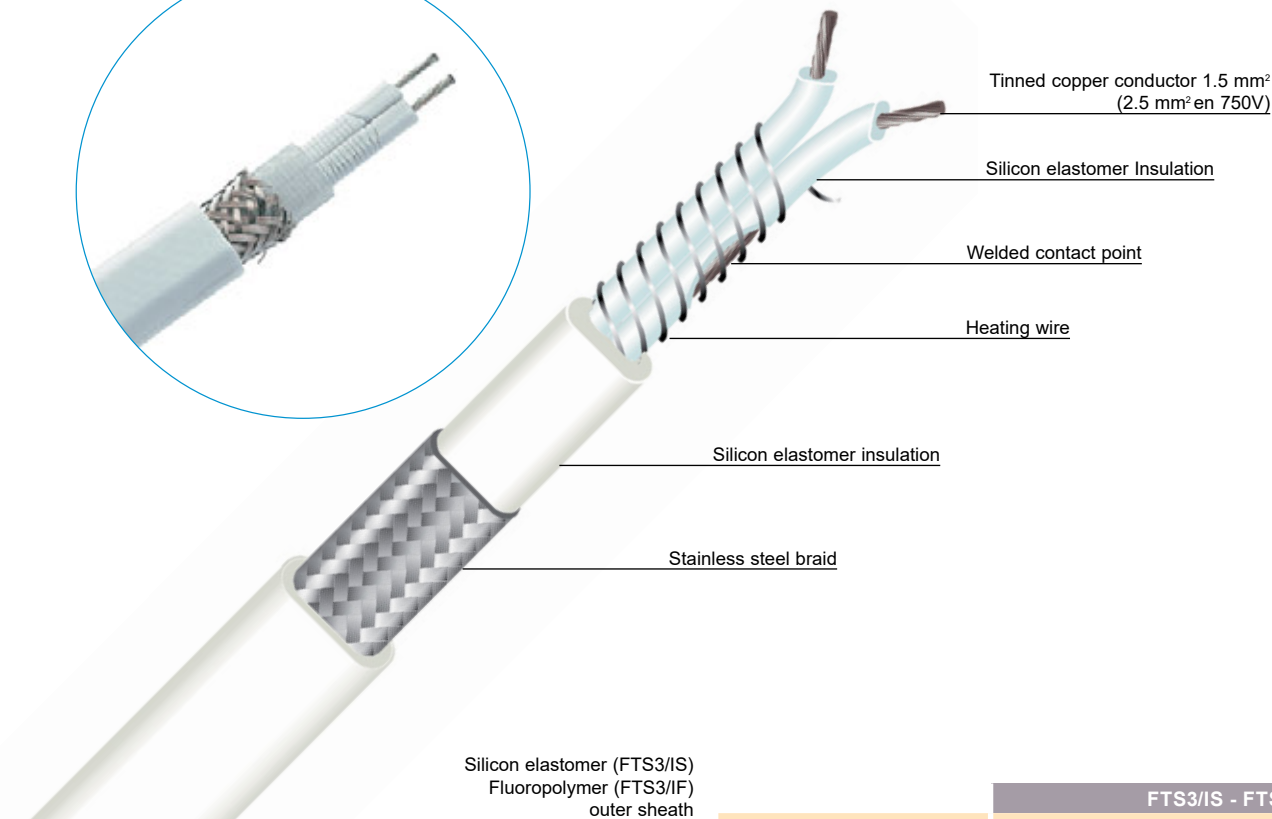

	FTS3/IS - FTS3/IF
Heating wire	Nickel-Copper or Nickel-Chrome
Dimensions	FTS3/IS : 9 x 16 mm - FTS3/IF : 7.6 x 13.6 mm
Power	100 W/m (up to 150W/m in 750v)
Permissible surface temperature	from - 70°C to + 200°C
Max. circuit length	40 m
Distance between 2 consecutive contact points	0.35 m in 230 or 750v 0.50 m in 400v
Ingress protection code	IP54 with our kits
Min. bending radius	6 x the thickness of cable

#### Use

Consult the pages of the catalogue devoted to the corresponding general operating principles, general instructions for use and accessories.

#### FLEXELEC S.A.S

10, rue des frères Lumière  
Z.A. du Bois Rond  
69720 ST BONNET DE MURE - FRANCE  
Tél : + 33 (0)4.72.48.30.90  
E-mail : flexelec@omerin.com

#### FLEXELEC Dept

OMERIN ASIA Pte Ltd  
51 Goldhill Plaza #08-11  
SINGAPORE 308900  
Tel : + 65 6255.4778  
Fax : + 65 6255.4779  
E-mail : sales@omerin.com.sg

#### FLEXELEC (UK) Ltd

Unit 11 Kings Park Industrial Estate  
Primrose Hill - KINGS LANGLEY  
Hertfordshire - WD4 8ST - UK  
Tel : + 44 (0) 1923.274477  
Fax : + 44 (0) 1923.270264  
E-mail : sales@omerin.co.uk

#### FLEXELEC Dept

OMERIN GmbH  
Buchwiese 16  
D-65510 IDSTEIN - GERMANY  
Tel : + 49 (0) 6126.94.31-0  
Fax : + 49 (0) 6126.83.999  
E-mail : omeringmbh@omerin.com

## TEMPERATURE MAINTENANCE SYSTEMS

# FTTH - FTTH/T - FTTH/I - FTTH/TF - FTTH/IS

## Fluoropolymer insulated constant power cables



### Characteristics

- Welded contact points.
- Hard-wearing and flexible.
- Can be cut to length on site.
- Extremely simple termination.
- Cold tail incorporated: no extra connection necessary.
- Available as 20, 30, 40 or 50 W/m.
- Power supply 230 V as standard (400 V on request).
- FTTH : fluoropolymer insulated constant power cables.
- FTTH/T : with tinned copper braid for mechanical protection and earthing.
- FTTH/I : with stainless steel braid for mechanical protection and earthing.
- FTTH/TF : with tinned copper braid and fluoropolymer anti-corrosion outer sheath.
- FTTH/IS : with stainless steel braid and silicon elastomer outer sheath.
- Special production on request.

### Applications

The FTTH range is particularly suitable for maintaining temperatures up to + 150°C.

Their fluoropolymer insulation endows them with the ability to withstand corrosive substances, making FTTH cables particularly well-suited for use in the chemical industry.

To ensure that these heating elements enjoy a long service life, we recommend using a control device.



### Standards

CEI 62395-1  
CEI 62395-2

Power	Distance between 2 consecutive contact points	Max. circuit length	Max. maintenance temperature
20 W/m	0.7 m	140 m	150°C
30 W/m	0.7 m	120 m	140°C
40 W/m	0.6 m	100 m	120°C
50 W/m	0.6 m	90 m	90°C

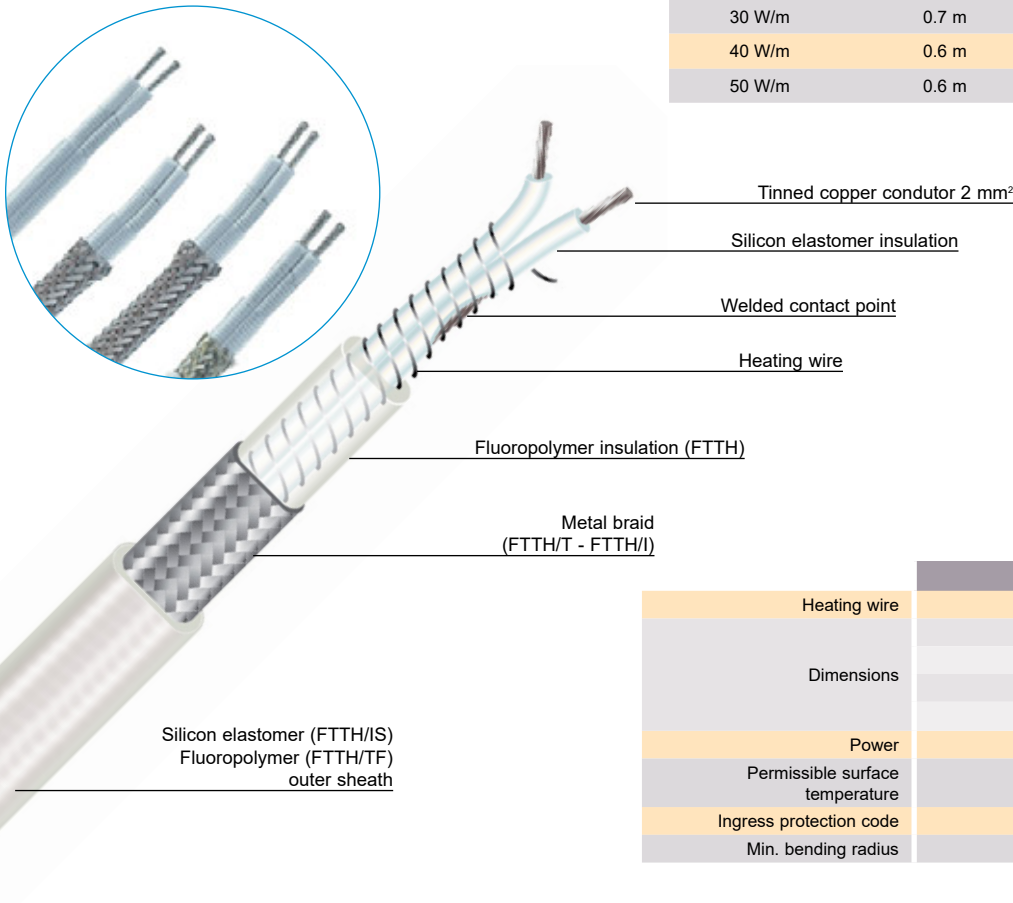

	FTTH
Heating wire	Nickel-Copper or Nickel-Chrome
Dimensions	FTTH : 5 x 8 mm
	FTTH/T - FTTH/I : 5.5 x 8.5 mm
	FTTH/TF : 6 x 9 mm
	FTTH/IS : 7 x 10 mm
Power	20, 30, 40 or 50 W/m
Permissible surface temperature	from - 70°C to + 200°C
Ingress protection code	IP54 with our kits
Min. bending radius	6 x the thickness of cable

### Use

Consult the pages of the catalogue devoted to the corresponding general operating principles, general instructions for use and accessories.

**TEMPERATURE MAINTENANCE SYSTEMS****FTX1****Polyethylene insulated constant power cables****Characteristics**

- Hard-wearing, flexible and sealed.
- Can be cut to length on site.
- Extremely simple termination.
- Cold tail incorporated: no extra connection necessary.
- Available as 10 W/m.
- Power supply 230 V.
- Copper braid and polyethylene outer sheath.
- Cable halogene free.
- Special production on request.

**Applications**

The FTX1 cable is specially designed for protecting pipes carrying water against freezing. Its completely sealed, polyethylene outer sheath means that it can be placed inside the pipes.

To ensure that these heating elements enjoy a long service life, we recommend using a control device.

**Standards**

CEI 62395-1  
 CEI 62395-2

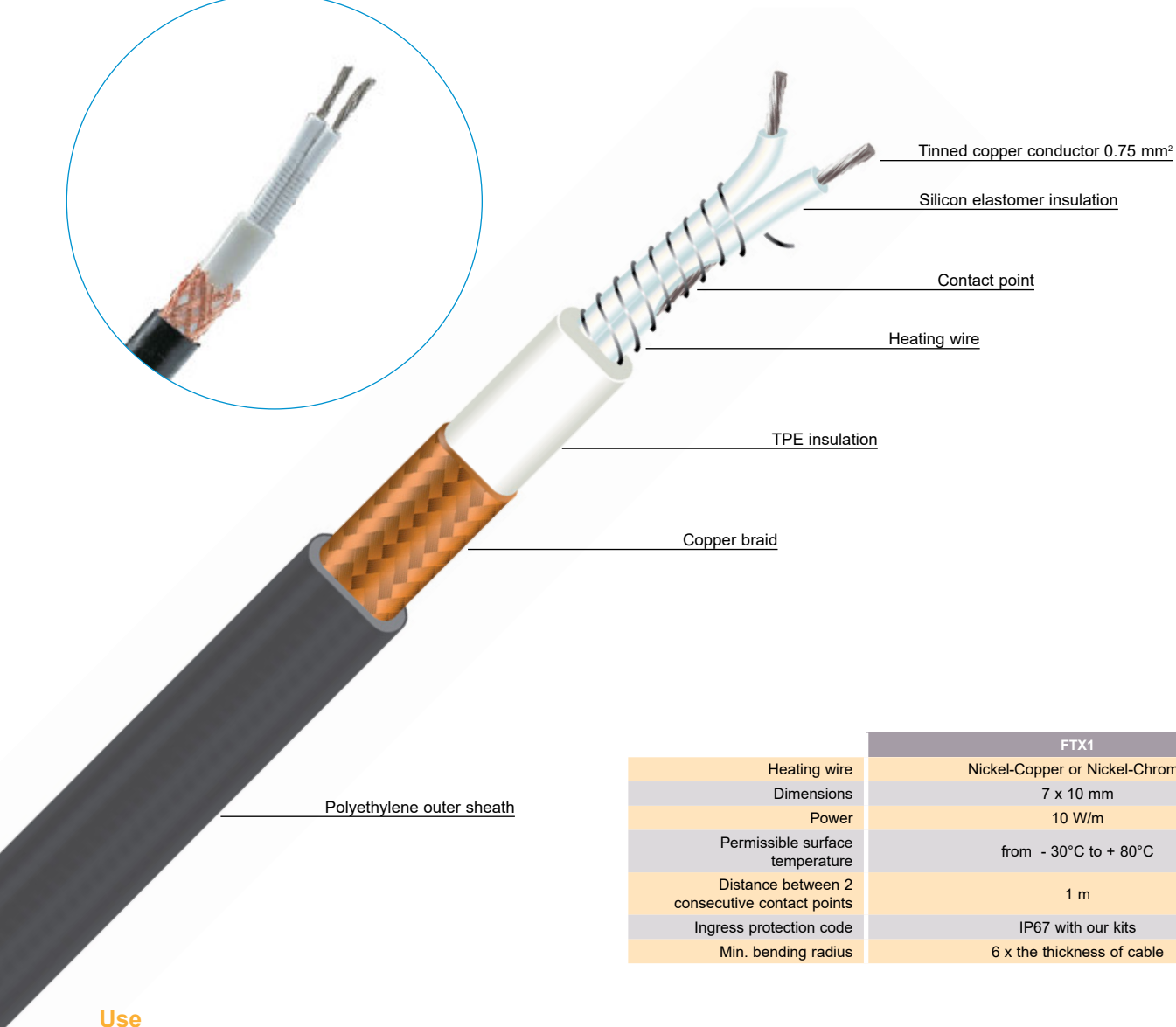
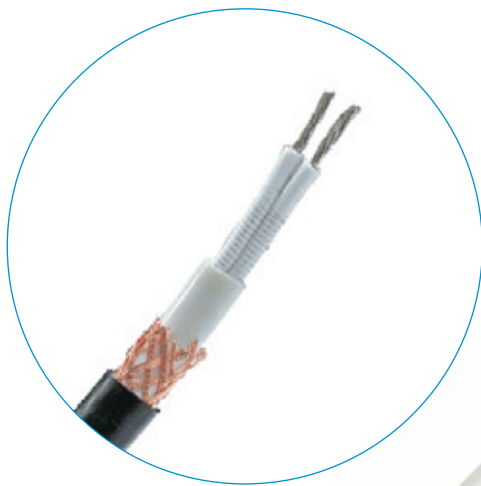

	FTX1
Heating wire	Nickel-Copper or Nickel-Chrome
Dimensions	7 x 10 mm
Power	10 W/m
Permissible surface temperature	from - 30°C to + 80°C
Distance between 2 consecutive contact points	1 m
Ingress protection code	IP67 with our kits
Min. bending radius	6 x the thickness of cable

**Use**

Consult the pages of the catalogue devoted to the corresponding general operating principles, general instructions for use and accessories.

**FLEXELEC S.A.S**

10, rue des frères Lumière  
 Z.A. du Bois Rond  
 69720 ST BONNET DE MURE - FRANCE  
 Tél : + 33 (0)4.72.48.30.90  
 E-mail : flexelec@omerin.com

**FLEXELEC Dept**

OMERIN ASIA Pte Ltd  
 51 Goldhill Plaza #08-11  
 SINGAPORE 308900  
 Tel : + 65 6255.4778  
 Fax : + 65 6255.4779  
 E-mail : sales@omerin.com.sg

**FLEXELEC (UK) Ltd**

Unit 11 Kings Park Industrial Estate  
 Primrose Hill - KINGS LANGLEY  
 Hertfordshire - WD4 8ST - UK  
 Tel : + 44 (0) 1923.274477  
 Fax : + 44 (0) 1923.270264  
 E-mail : sales@omerin.co.uk

**FLEXELEC Dept**

OMERIN GmbH  
 Buchwiese 16  
 D-65510 IDSTEIN - GERMANY  
 Tel : + 49 (0) 6126.94.31-0  
 Fax : + 49 (0) 6126.83.999  
 E-mail : omeringmbh@omerin.com

## TEMPERATURE MAINTENANCE SYSTEMS

### C1FS/I - C2FS/I - C3FS/I Long cables and tapes



#### Characteristics

- Designed according to customer requirements.
- For very long circuits.
- Highly corrosion-resistant.
- Connection via tubular connectors and heat-shrink sheath.
- Stainless steel braid.
- Mechanical protection and earthing.
- Fluoropolymer and silicon elastomer insulation.
- Special production on request.

#### Applications

C1FS/I cables are specially designed for heating concrete tracks for VAL type metros. They can be terminated into copper tubes.

C2FS/I cables are specially designed for heating metal metro tracks and rails of the VAL type. They can be slid inside a U-shaped composite profile clamped against the rail with stainless steel clips.

C3FS/I tapes are used when it is required to trace very long stretches, where a 400V, 3-phase power supply is available, for example in pits or tunnels.

To ensure that these heating elements enjoy a long service life, we recommend using a control device.

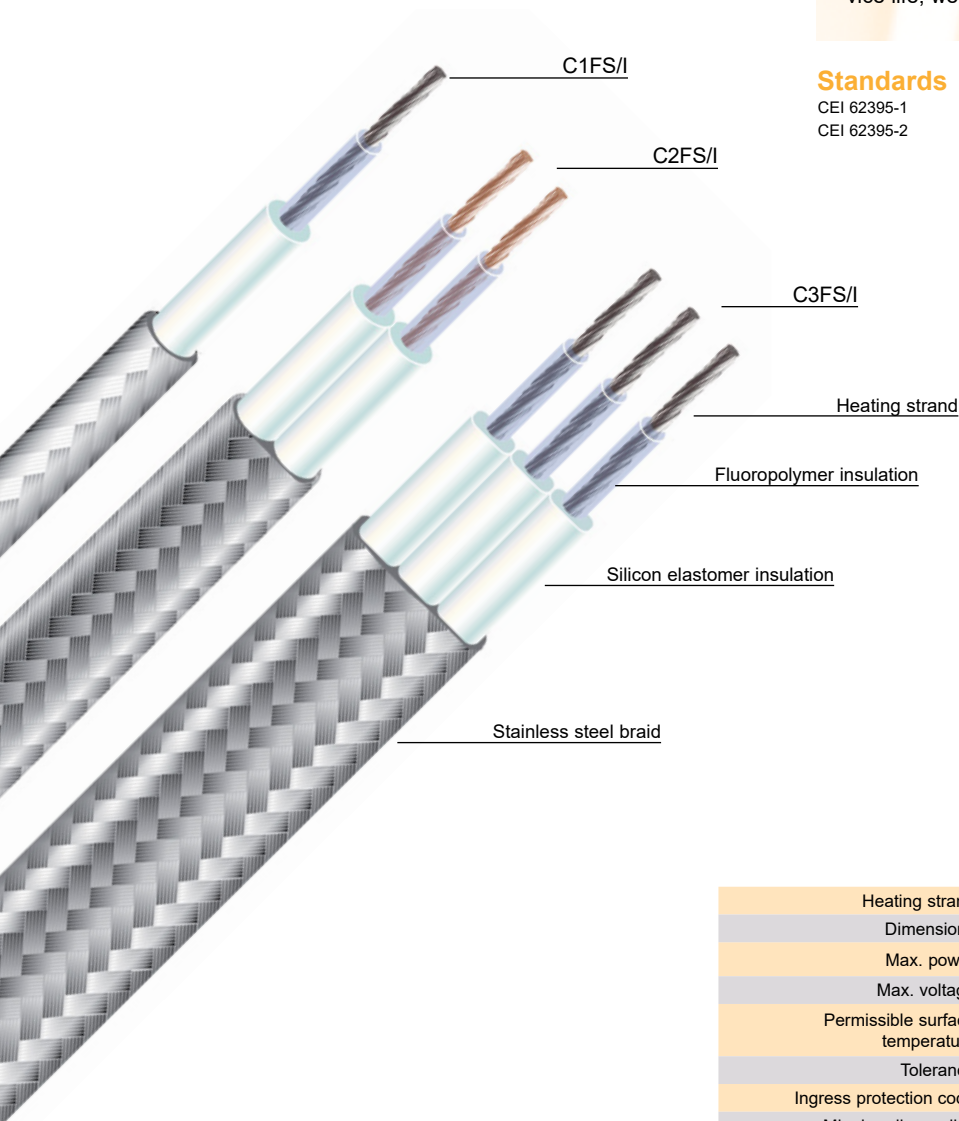

#### Standards

CEI 62395-1  
CEI 62395-2

NF EN 60077-1  
NF EN 60077-2



	C1FS/I	C2FS/I	C3FS/I
Heating strand	Nickel-Copper or Nickel-Chrome		
Dimensions	Ø 6.5 mm	5 x 9 mm	7 x 16 mm
Max. power	40 W/m	60 W/m	80 W/m
Max. voltage	750 V		
Permissible surface temperature	de - 70°C to + 200°C		
Tolerance	Resistance ± 10 %		
Ingress protection code	IP54 with our kits		
Min. bending radius	6 x the diameter or the thickness		

#### Use

Consult the pages of the catalogue devoted to the corresponding general operating principles, general instructions for use and accessories.

#### FLEXELEC S.A.S

10, rue des frères Lumière  
Z.A. du Bois Rond  
69720 ST BONNET DE MURE - FRANCE  
Tél : + 33 (0)4.72.48.30.90

E-mail : [flexelec@omerin.com](mailto:flexelec@omerin.com)

#### FLEXELEC Dept

OMERIN ASIA Pte Ltd  
51 Goldhill Plaza #08-11  
SINGAPORE 308900  
Tel : + 65 6255 4778  
Fax : + 65 6255 4779  
E-mail : [sales@omerin.com.sg](mailto:sales@omerin.com.sg)

#### FLEXELEC (UK) Ltd

Unit 11 Kings Park Industrial Estate  
Primrose Hill - KINGS LANGLEY  
Hertfordshire - WD4 8ST - UK  
Tel : + 44 (0) 1923.274477  
Fax : + 44 (0) 1923.270264  
E-mail : [sales@omerin.co.uk](mailto:sales@omerin.co.uk)

#### FLEXELEC Dept

OMERIN GmbH  
Buchwiese 16  
D-65510 IDSTEIN - GERMANY  
Tel : + 49 (0) 6126.94.31-0  
Fax : + 49 (0) 6126.83.999  
E-mail : [omerinmbh@omerin.com](mailto:omerinmbh@omerin.com)

## TEMPERATURE MAINTENANCE SYSTEMS

### C4FS/IS Long cables and tapes



#### Characteristics

- Designed according to customer requirements.
- For very long circuits.
- Highly corrosion-resistant.
- Connection via tubular connectors and heat-shrink sheath.
- Stainless steel braid.
- Mechanical protection and earthing.
- Fluoropolymer and silicon elastomer insulation.
- Special production on request.

#### Applications

C4FS/IS cables are used when it is required to trace very long stretches, where electrical supply is available only at one end, for example in case of pits, tunnels, heating tracks, pipes,...

Through their building, these heating cables allow a power modulation from single to double thanks to an adequate electrical coupling.

To ensure that these heating elements enjoy a long service life, we recommend using a control device.



#### Standards

CEI 62395-1  
CEI 62395-2

NF EN 60077-1  
NF EN 60077-2

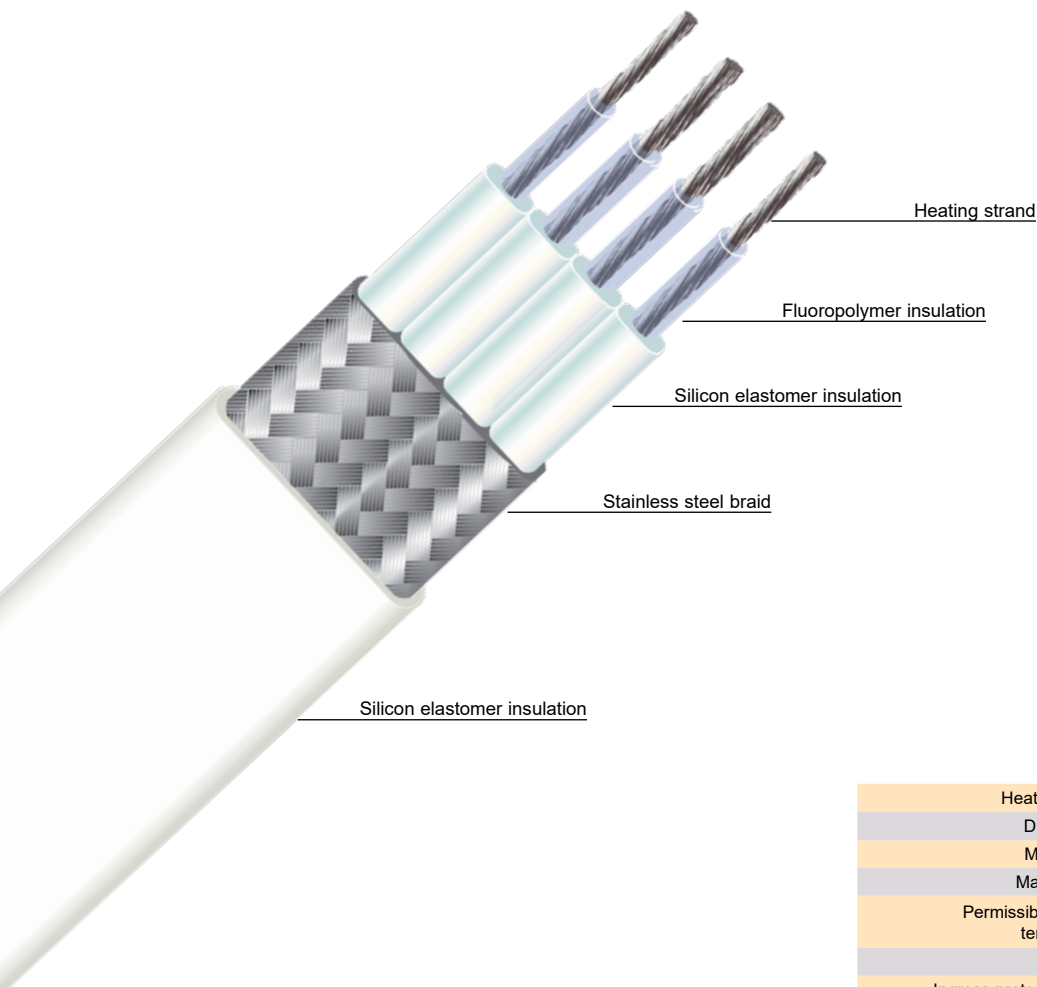

Example of electrical tracing type 1

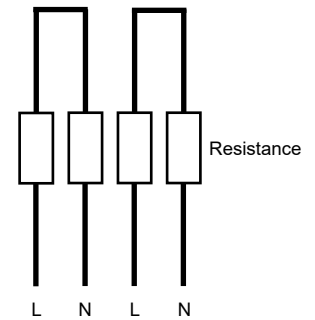

Example of electrical tracing type 2

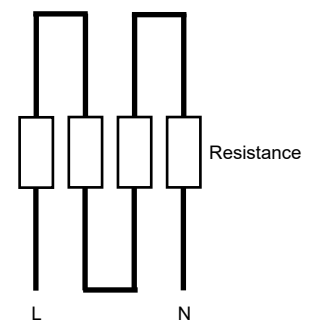

	C4FS/IS
Heating strand	Nickel-Copper or Nickel-Chrome
Dimensions	6 x 16.8 mm
Max. power	120 W/m
Max. voltage	1000 V according to IEC 62395-1
Permissible surface temperature	From - 70°C to + 200°C
Tolerance	Resistance $\pm$ 10 %
Ingress protection code	IP54 with our kits
Min. bending radius	6 x the thickness of cable

#### Use

Consult the pages of the catalogue devoted to the corresponding general operating principles, general instructions for use and accessories.

#### FLEXELEC S.A.S

10, rue des frères Lumière  
Z.A. du Bois Rond  
69720 ST BONNET DE MURE - FRANCE  
Tél : + 33 (0)4.72.48.30.90

E-mail : [flexelec@omerin.com](mailto:flexelec@omerin.com)

#### FLEXELEC Dept

OMERIN ASIA Pte Ltd  
51 Goldhill Plaza #08-11  
SINGAPORE 308900  
Tel : + 65 6255.4778  
Fax : + 65 6255.4779  
E-mail : [sales@omerin.com.sg](mailto:sales@omerin.com.sg)

#### FLEXELEC (UK) Ltd

Unit 11 Kings Park Industrial Estate  
Primrose Hill - KINGS LANGLEY  
Hertfordshire - WD4 8ST - UK  
Tel : + 44 (0) 1923.274477  
Fax : + 44 (0) 1923.270264  
E-mail : [sales@omerin.co.uk](mailto:sales@omerin.co.uk)

#### FLEXELEC Dept

OMERIN GmbH  
Buchwiese 16  
D-65510 IDSTEIN - GERMANY  
Tel : + 49 (0) 6126.94.31-0  
Fax : + 49 (0) 6126.83.999  
E-mail : [omerinmbh@omerin.com](mailto:omerinmbh@omerin.com)



### SR - SRHT Long cables and tapes



#### Characteristics

- Designed according to customer requirements.
- For very long circuits.
- Highly corrosion-resistant.
- Very good resistance to mechanical stress.
- Connection with specific accessories.
- Nickel-copper braid, for mechanical protection and earthing.
- Fluoropolymer insulation.
- Special production on request.

#### Applications

SR and SRHT cables are used when it is required to trace very long stretches, where power supply is available only at one end for example in pits, tunnels, heating tracks, pipes,...

Due to their constitution, these heating cables are particularly adapted for frost protection and temperature maintenance in corrosive areas.

To ensure that these heating elements enjoy a long service life, we recommend using a control device.



#### Standards

CEI 62395-1	NF EN 60077-1
CEI 62395-2	NF EN 60077-2
CAN/CSA-C22.2 n°130-03	NF EN 60079-30-1
C22.2 N° 210 (cUL)	NF EN IEC 60079-0
	NF EN 60079-7

#### Resistance characteristics

The table below gives the resistance values in Ohm / m at the nominal voltage and for an ambient temperature of 20 ° C.

These values indicate the linear resistance for each conductor. Power supply variations and temperature coefficients may affect the given values.

The connection and use of these products are aimed to electrical professionals.

Contact our technical service for more information.

Typ	Max. linear resistance per conductor at +20°C in Ohms/m
SR1 : 1 conductor SR2 : 2 conductors SR3 : 3 conductors	0,01939
	0,01512
	0,00955
	0,00600
	0,00348
	0,00243

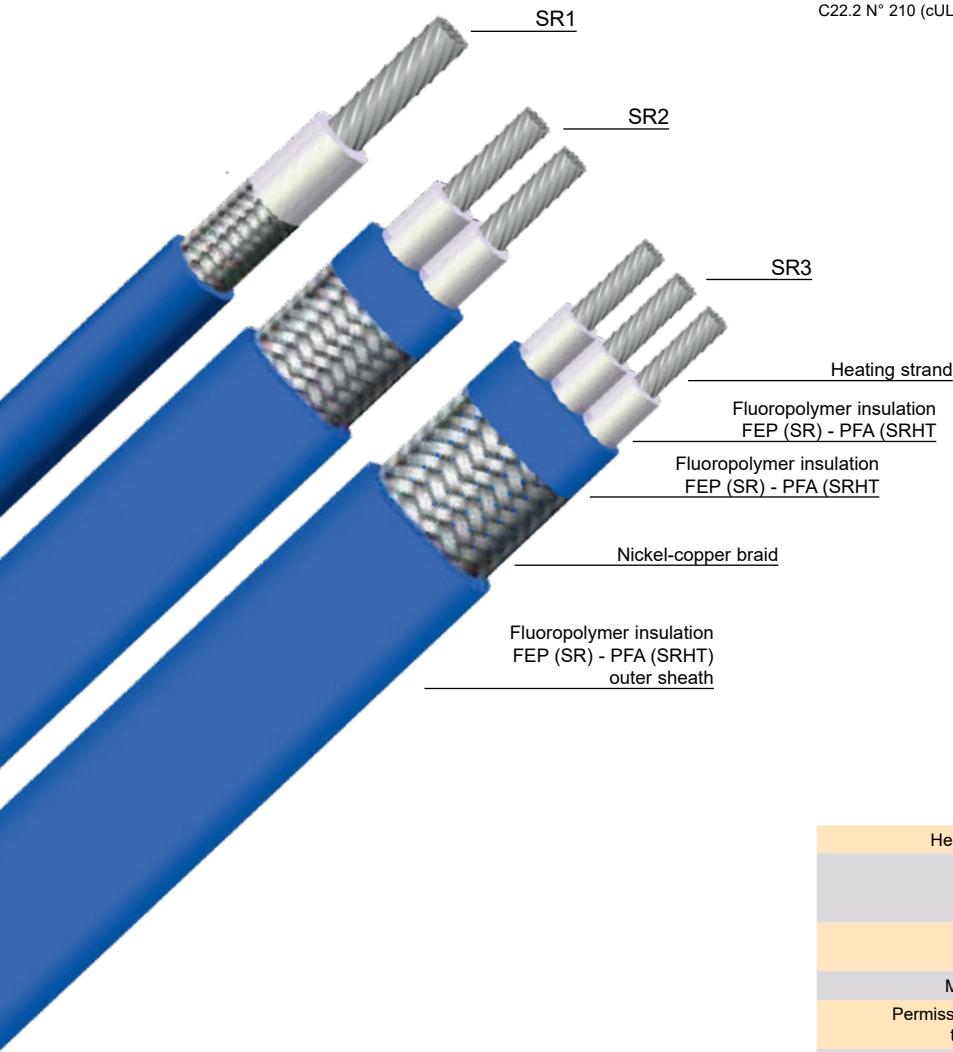

#### Use

Consult the pages of the catalogue devoted to the corresponding general operating principles, general instructions for use and accessories.

	SR	SRHT
Heating strand	Nickel-Copper or Nickel-Chrome	
Dimensions	SR1 : Diameter 5 to 8 mm SR2 : 6x9 to 10x15 mm SR3 : 6x12 to 10x19 mm	
Max. power	40 W/m of cable (UL version) others contact us	
Max. voltage	600 V	1200 V
Permissible surface temperature	From - 60°C to + 200°C	From - 60°C to + 260°C
Tolerance	Resistance ± 10 %	
Min. bending radius	6 x the diameter or the thickness	
Ingress protection code	IP54 to IP67 with our kits	

#### FLEXELEC S.A.S

10, rue des frères Lumière  
Z.A. du Bois Rond  
69720 ST BONNET DE MURE - FRANCE  
Tél : + 33 (0)4.72.48.30.90

E-mail : [flexelec@omerin.com](mailto:flexelec@omerin.com)

#### FLEXELEC Dept

OMERIN ASIA Pte Ltd  
51 Goldhill Plaza #08-11  
SINGAPORE 308900  
Tel : + 65 6255.4778  
Fax : + 65 6255.4779  
E-mail : [sales@omerin.com.sg](mailto:sales@omerin.com.sg)

#### FLEXELEC (UK) Ltd

Unit 11 Kings Park Industrial Estate  
Primrose Hill - KINGS LANGLEY  
Hertfordshire - WD4 8ST - UK  
Tel : + 44 (0) 1923.274477  
Fax : + 44 (0) 1923.270264  
E-mail : [sales@omerin.co.uk](mailto:sales@omerin.co.uk)

#### FLEXELEC Dept

OMERIN GmbH  
Buchwiese 16  
D-65510 IDSTEIN - GERMANY  
Tel : + 49 (0) 6126.94.31-0  
Fax : + 49 (0) 6126.83.999  
E-mail : [omerinmbh@omerin.com](mailto:omerinmbh@omerin.com)

**TEMPERATURE MAINTENANCE SYSTEMS**

**SR - SRHT  
Long cables and tapes**

**Circuit lengths for 2 conductors serie coupling**

The graphs below indicate the nominal power at +20°C in function of the total length of cable installed at a rated voltage. The lengths represent the totality of installed cables, in serie coupling under a single phase voltage, for SR1 and SR2 version.

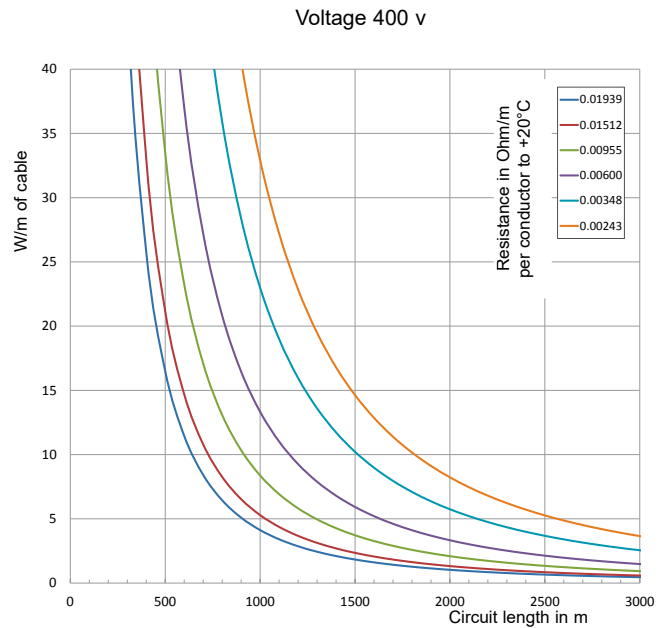
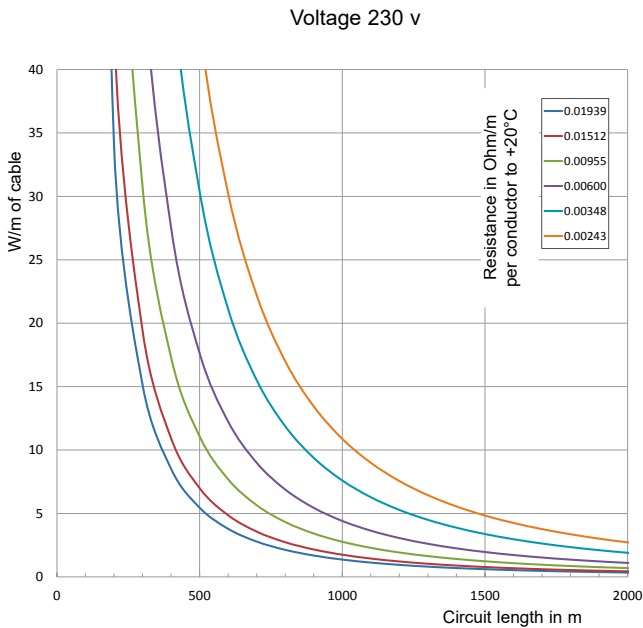

**Circuit lengths for 3 conductors star coupling**

The graphs below indicate the nominal power at +20°C in function of the total length of cable installed at a rated voltage. The lengths represent the totality of installed cables, in star coupling at the end of the circuit with a 3-phase power-supply, for SR3 versions.

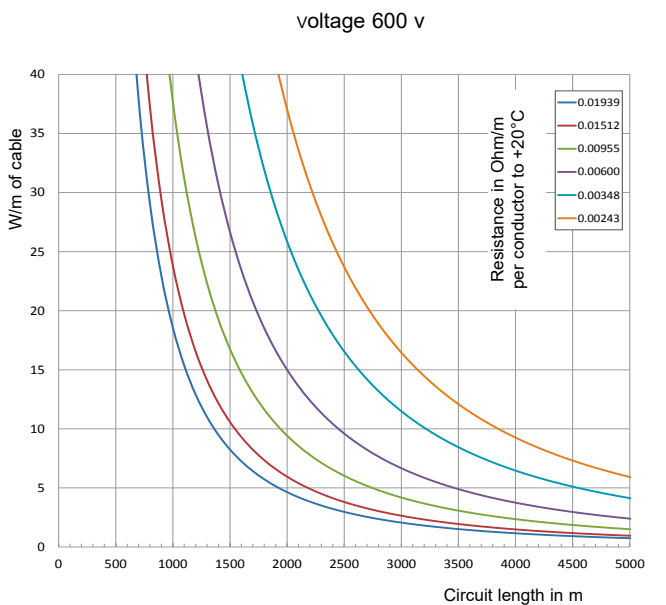
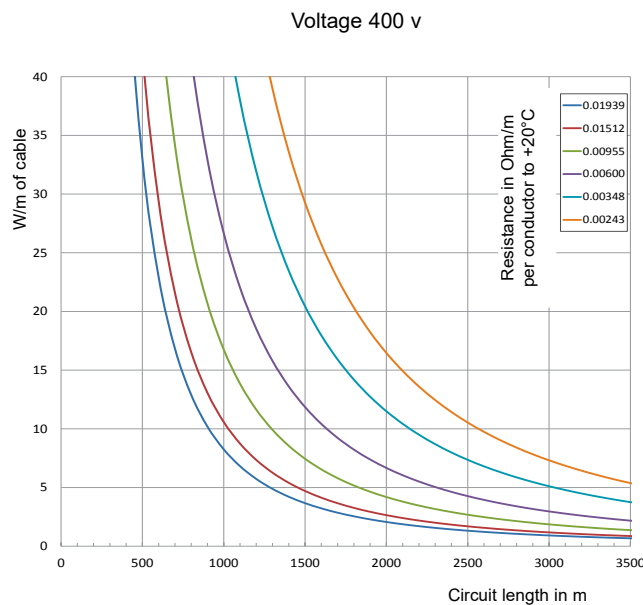

## TEMPERATURE MAINTENANCE SYSTEMS



# ZFE/CGE/ATEX - ZFA/CGA/ATEX ATEX fluoropolymer insulated constant power cables

### Characteristics

- Welded contact points.
- Can be cut to length on site.
- Extremely simple termination.
- Cold tail incorporated: no extra connection necessary.
- Available as 10, 20, 30 or 40 W/m.
- ZFA/CGA/ATEX also available as 50 W/m.
- Power supply 230 V as standard.
- ZFE/CGE/ATEX : PFE fluoropolymer insulated constant power cables with tinned copper braid and PFE fluoropolymer outer sheath.
- ZFA/CGA/ATEX : PFA fluoropolymer insulated constant power cables with tinned copper braid and PFA fluoropolymer outer sheath.
- Special production on request.
- Ingress protection code : IP54 with our kits

### Applications

ZFE/CGE/ATEX and ZFA/CGA/ATEX cables are particularly suitable for maintaining temperatures of up to + 150°C.

Their fluoropolymer insulation endows them with the ability to withstand corrosive substances, making these cables particularly well-suited for use in the chemical industry.

These cables can be used in an explosive atmosphere with the appropriate accessories.

To ensure that these heating elements enjoy a long service life, we recommend using a control device.



ATEX certificate: LCIE N° 03ATEX6302X Ex II 2G/D

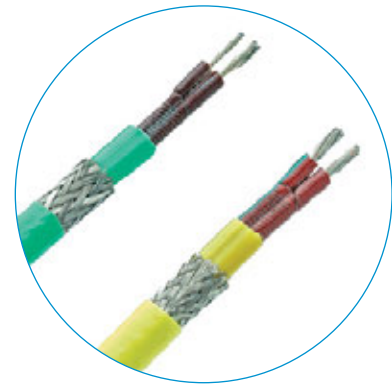
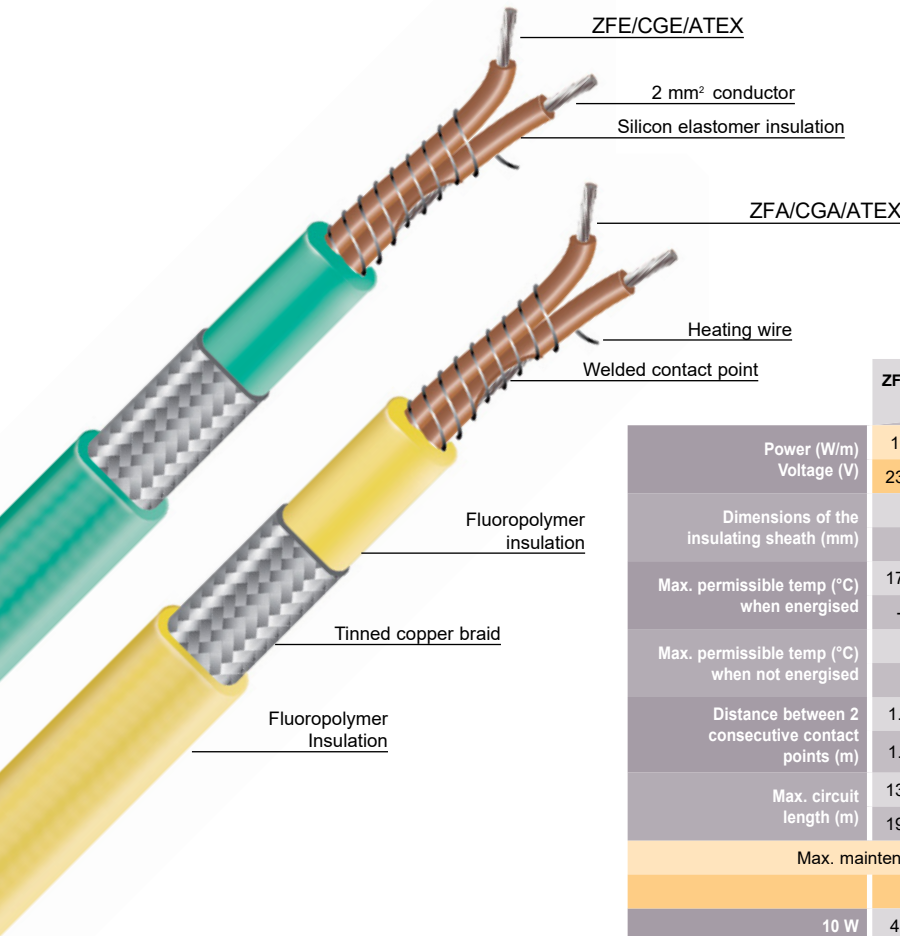

	ZFE/CGE/ATEX					ZFA/CGA/ATEX				
	10	10	20	20	30	30	40	40	50	50
Power (W/m) Voltage (V)	230	400	230	400	230	400	230	400	230	400
Dimensions of the insulating sheath (mm)	5.0 x 7.3 4.6 x 7.5									
Max. permissible temp (°C) when energised	170	-	145	-	115	-	75	-	-	-
Max. permissible temp (°C) when not energised	205 260									
Distance between 2 consecutive contact points (m)	1.2	-	1	-	1	-	1	-	-	-
	1.2	2	1	1.5	1	1.2	1	1	1	1
Max. circuit length (m)	130	-	90	-	70	-	60	-	-	-
	190	220	120	170	100	160	90	150	75	135
Max. maintenance temperature for a given temperature class (°C)										
	T6		T5		T4		T3		T2	
10 W	45	45	60	60	95	95	160	160	160	215
20 W	X	X	30	30	70	70	135	135	135	190
30 W	X	X	X	X	40	40	115	115	115	170
40 W	X	X	X	X	X	X	90	90	90	145
50 W	-	X	-	X	-	X	-	53	-	95

### Use

Consult the pages of the catalogue devoted to the corresponding general operating principles, general instructions for use and accessories.

# Flexible heating cables and elements temperature maintenance systems



## **FLEXFLOOR®**

### UNDERFLOOR HEATING CABLES

KY - KYCY	CABLES FOR UNDERFLOOR HEATING	68
KYCYR	SERIE CABLES FOR UNDERFLOOR HEATING	69
KYX	SERIE CABLES FOR ROAD HEATING	70

## TEMPERATURE MAINTENANCE SYSTEMS

### KY - KYCY Underfloor heating cables



#### Characteristics

- Hard-wearing and flexible.
- Mechanical protection and earthing.
- KYCY sold by the meter or as a flex with 5 m of power cable at each end.
- **KY** : series cables, silicon elastomer insulated and PVC sheath.
- **KYCY** : series cables with an identical base to that of KY cables, with copper braided shielding and an extra PVC outer sheath.
- Special production on request.
- Ingress protection code : IP54 terminated cable by ourself, KY cable IK07, KYCY cable IK08.

#### Applications

KYCY cables are particularly hard-wearing and are used for applications set in concrete slabs to protect against freezing or to maintain a temperature.

The cables must be set in accordance with the local regulations in force: in France these include DTU 65-7 published by AFNOR.

KY cables are for applications in which mechanical resistance is not so critical.

To ensure that these heating elements enjoy a long service life, we recommend using a control device



#### Standards

CEI 62395-1  
CEI 62395-2

NF P 52-302-1 + annex A1  
NF P 52-302-2 (DTU 65.7)

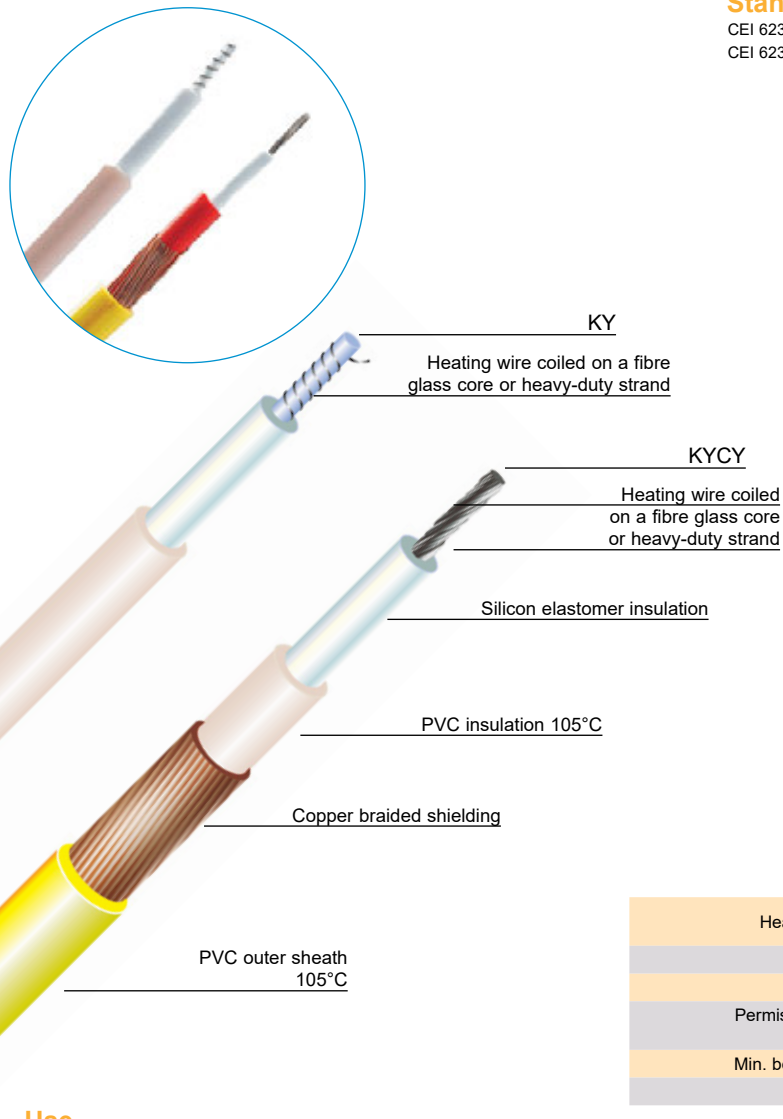

#### Minimum useable lengths (m)

Resistance (Ω/m)	KY		KYCY	
	230 V	400 V	230 V	400 V
0.03	297	516	265	462
0.058	214	372	191	333
0.078	185	321	165	287
0.11	151	270	139	241
0.14	138	239	123	214
0.17	125	217	112	194
0.24	105	183	94	163
0.34	89	154	79	137
0.47	75	131	67	117
0.65	64	111	57	99
1	52	90	46	80
1.47	43	74	38	66
1.9	38	65	34	58
2.9	31	53	27	47
4	26	45	23	40
8	18.5	32	16.5	28.5
18	12.5	21	11	19

	KY	KYCY
Heating element	Heavy-duty strand or coiled heating wire Nickel-Copper or Nickel-Chrome	
Diameter	4 to 5 mm	6 to 7 mm
Max. power	20 W/m	25 W/m
Permissible surface temperature	up to + 80°C	
Min. bending radius	6 x the diameter	
Tolerance	Resistance : - 5% / + 10%	

#### Use

Consult the pages of the catalogue devoted to the corresponding general operating principles, general instructions for use and accessories.

## TEMPERATURE MAINTENANCE SYSTEMS

### KYCYR Series cables for underfloor heating



#### Characteristics

- Hard-wearing and flexible.
- For mechanical protection and earthing.
- 3 m power cable on one end only, integrated return conductor.
- Power supply : 230 V as standard.
- Series resistance, silicon elastomer and PVC insulation, with copper braided shielding and an extra PVC outer sheath.
- Special production on request.
- Ingress protection code : IP65 terminated cable by ourself, - IK08.

#### Applications

KYCYR heating cables are particularly hard-wearing and are used for applications set in concrete slabs to protect against freezing or to maintain a temperature.

The cables must be set in accordance with the local regulations in force: in France these include DTU65-7 published by AFNOR.

To ensure that these heating elements enjoy a long service life, we recommend using a control device



#### Standards

CEI 62395-1  
CEI 62395-2

NF P 52-302-1 + annex A1  
NF P 52-302-2 (DTU 65.7)

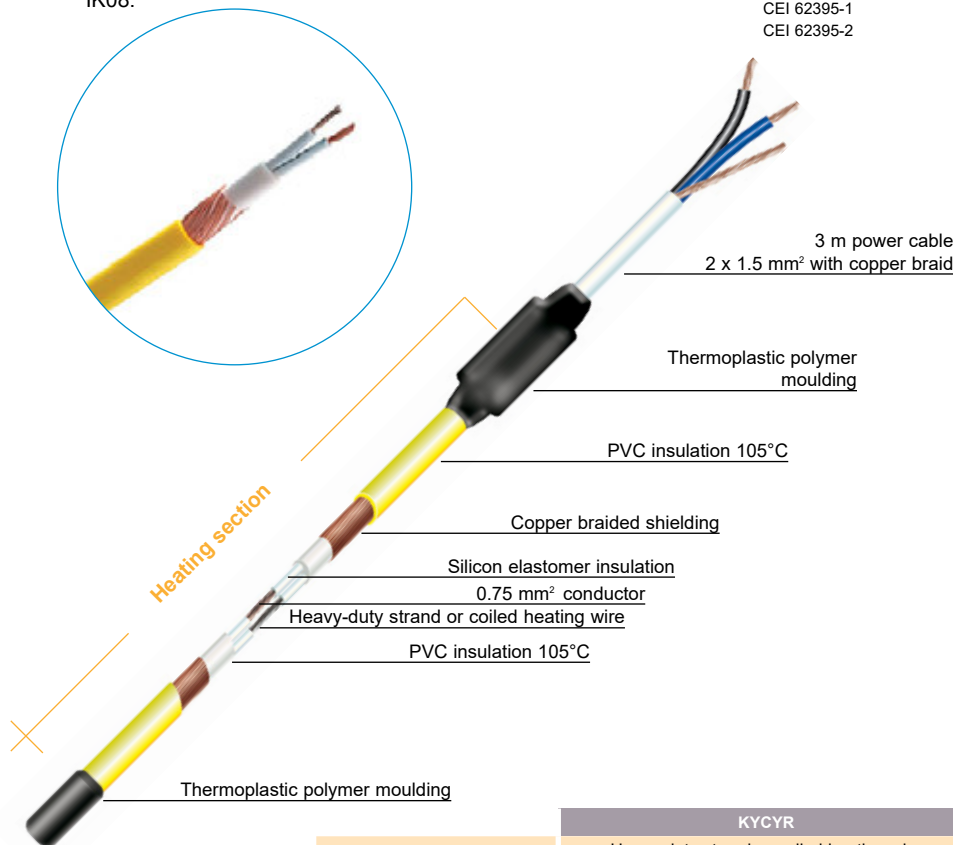

#### Standard 230 V models

20 W/m		
Length (m)	Power (W)	Resistance (Ω/m)
10	200	27.0
15	300	11.8
20	400	6.7
30	600	2.8
40	800	1.65
48	940	1.15
55	1100	0.87
75	1500	0.47
90	1800	0.30
113	2100	0.20

10 W/m		
Length (m)	Power (W)	Resistance (Ω/m)
13	100	41.0
14	140	27.0
15.5	206	16.0
18	180	16.0
20	160	16.0
20	285	9.2
21	210	11.8
24	240	9.2
28	280	6.7
36	360	4.0
44	430	2.8
49	480	2.24
57	560	1.65
68	660	1.15
78	780	0.87
92	920	0.6
104	1040	0.47
128	1280	0.3
155	1550	0.2

KYCYR	
Heating element	Heavy-duty strand or coiled heating wire (Nickel-Copper or Nickel-Chrome)
Diameter	7 to 8 mm
Max. power	27 W/m
Permissible surface temperature	up to + 80°C
Min. bending radius	6 x the diameter
Tolerance	Resistance : - 5% / + 10% Length ± 1 %

#### Use

Consult the pages of the catalogue devoted to the corresponding general operating principles, general instructions for use and accessories.

#### FLEXELEC S.A.S

10, rue des frères Lumière  
Z.A. du Bois Rond  
69720 ST BONNET DE MURE - FRANCE  
Tél : + 33 (0)4.72.48.30.90

E-mail : [flexelec@omerin.com](mailto:flexelec@omerin.com)

#### FLEXELEC Dept

OMERIN ASIA Pte Ltd  
51 Goldhill Plaza #08-11  
SINGAPORE 308900  
Tel : + 65 6255.4778  
Fax : + 65 6255.4779  
E-mail : [sales@omerin.com.sg](mailto:sales@omerin.com.sg)

#### FLEXELEC (UK) Ltd

Unit 11 Kings Park Industrial Estate  
Primrose Hill - KINGS LANGLEY  
Hertfordshire - WD4 8ST - UK  
Tel : + 44 (0) 1923.274477  
Fax : + 44 (0) 1923.270264  
E-mail : [sales@omerin.co.uk](mailto:sales@omerin.co.uk)

#### FLEXELEC Dept

OMERIN GmbH  
Buchwiese 16  
D-65510 IDSTEIN - GERMANY  
Tel : + 49 (0) 6126.94.31-0  
Fax : + 49 (0) 6126.83.999  
E-mail : [omerinmbh@omerin.com](mailto:omerinmbh@omerin.com)

## TEMPERATURE MAINTENANCE SYSTEMS

### KYX Series cables for road heating



#### Characteristics

- Hard-wearing and flexible.
- Mechanical protection and earthing.
- Will withstand at the temperature at which asphalt is laid.
- Series resistance: 0.058 at 1 Ω /m.
- Silicon elastomer insulation, with copper braided shielding and an outer XLPE cross linked polyethylene sheath.
- Special production on request.
- Ingress protection code : IP67 terminated cable by ourself - IK09.

#### Applications

KYX cables are used for heating floors, roads or access ramps.

They are specially designed to be laid between 2 layers of road surface.

Cables must be set in roads in accordance with local regulations.

To ensure that these heating elements enjoy a long service life, we recommend using a control device



#### Standards

CEI 62395-1  
CEI 62395-2

NF P 52-302-1 + annex A1  
NF P 52-302-2 (DTU 65.7)

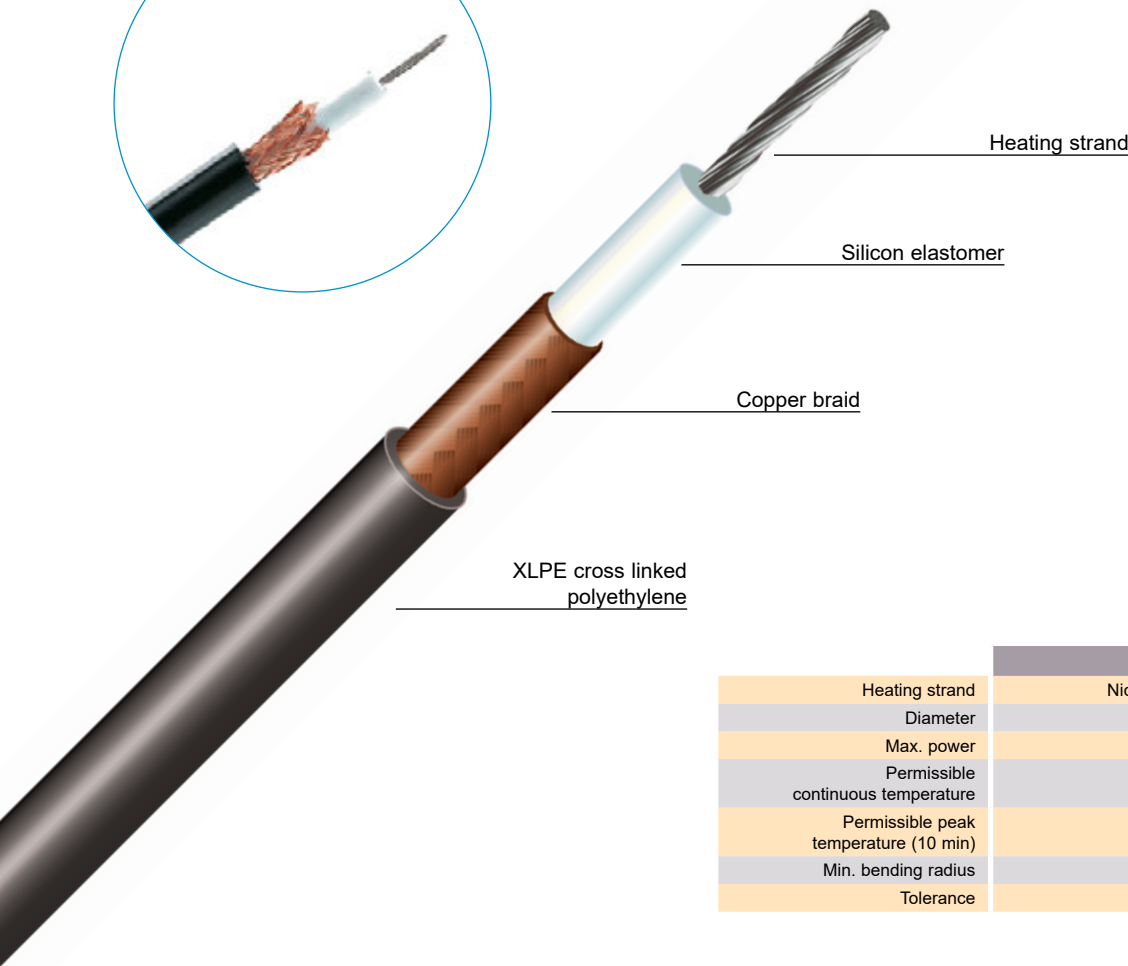
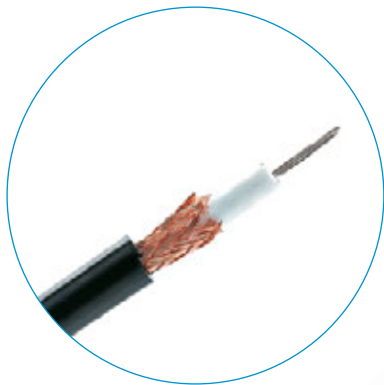

	KYX
Heating strand	Nickel-Copper or Nickel-Chrome
Diameter	7 mm
Max. power	30 W/m
Permissible continuous temperature	up to + 90°C
Permissible peak temperature (10 min)	up to + 250°C
Min. bending radius	6 x the diameter
Tolerance	Resistance - 5% + 10%

#### Use

Consult the pages of the catalogue devoted to the corresponding general operating principles, general instructions for use and accessories.

#### FLEXELEC S.A.S

10, rue des frères Lumière  
Z.A. du Bois Rond  
69720 ST BONNET DE MURE - FRANCE  
Tél : + 33 (0)4.72.48.30.90

E-mail : flexelec@omerin.com

#### FLEXELEC Dept

OMERIN ASIA Pte Ltd  
51 Goldhill Plaza #08-11  
SINGAPORE 308900  
Tel : + 65 6255 4778  
Fax : + 65 6255 4779  
E-mail : sales@omerin.com.sg

#### FLEXELEC (UK) Ltd

Unit 11 Kings Park Industrial Estate  
Primrose Hill - KINGS LANGLEY  
Hertfordshire - WD4 8ST - UK  
Tel : + 44 (0) 1923.274477  
Fax : + 44 (0) 1923.270264  
E-mail : sales@omerin.co.uk

#### FLEXELEC Dept

OMERIN GmbH  
Buchwiese 16  
D-65510 IDSTEIN - GERMANY  
Tel : + 49 (0) 6126.94.31-0  
Fax : + 49 (0) 6126.83.999  
E-mail : omeringmbh@omerin.com

# Flexible heating cables and elements temperature maintenance systems



## **FLEXBELT®**

### HEATING BELTS

FCH	HEATING BELTS FOR REFRIGERATION COMPRESSORS	72
FCHK	HEATING BELTS FOR REFRIGERATION COMPRESSORS WITH INTEGRATED THERMOSTAT	73



## TEMPERATURE MAINTENANCE SYSTEMS



# FCH Heating belts for refrigeration compressors

### Characteristics

- Quick, safe and easy to fit.
- Sealed silicon insulated heating element.
- Metal braid for earthing.
- Voltage 230 V as standard.
- belts on request.
- Special production on request.
- Ingress protection code : IP54

### Applications

FCH heating belts are fitted to refrigerating compressors to prevent the coolant from being absorbed by the oil.

The lower the temperature, the quicker and the more complete the absorption, which can seriously damage the compressor, especially when starting up, through lack of lubrication.

To ensure that these heating elements enjoy a long service life, we recommend using a control device

### Standards

- CEI 62395-1
- CEI 62395-2
- C22.2 N° 210 (cUL) on request
- UL758 (UL) on request

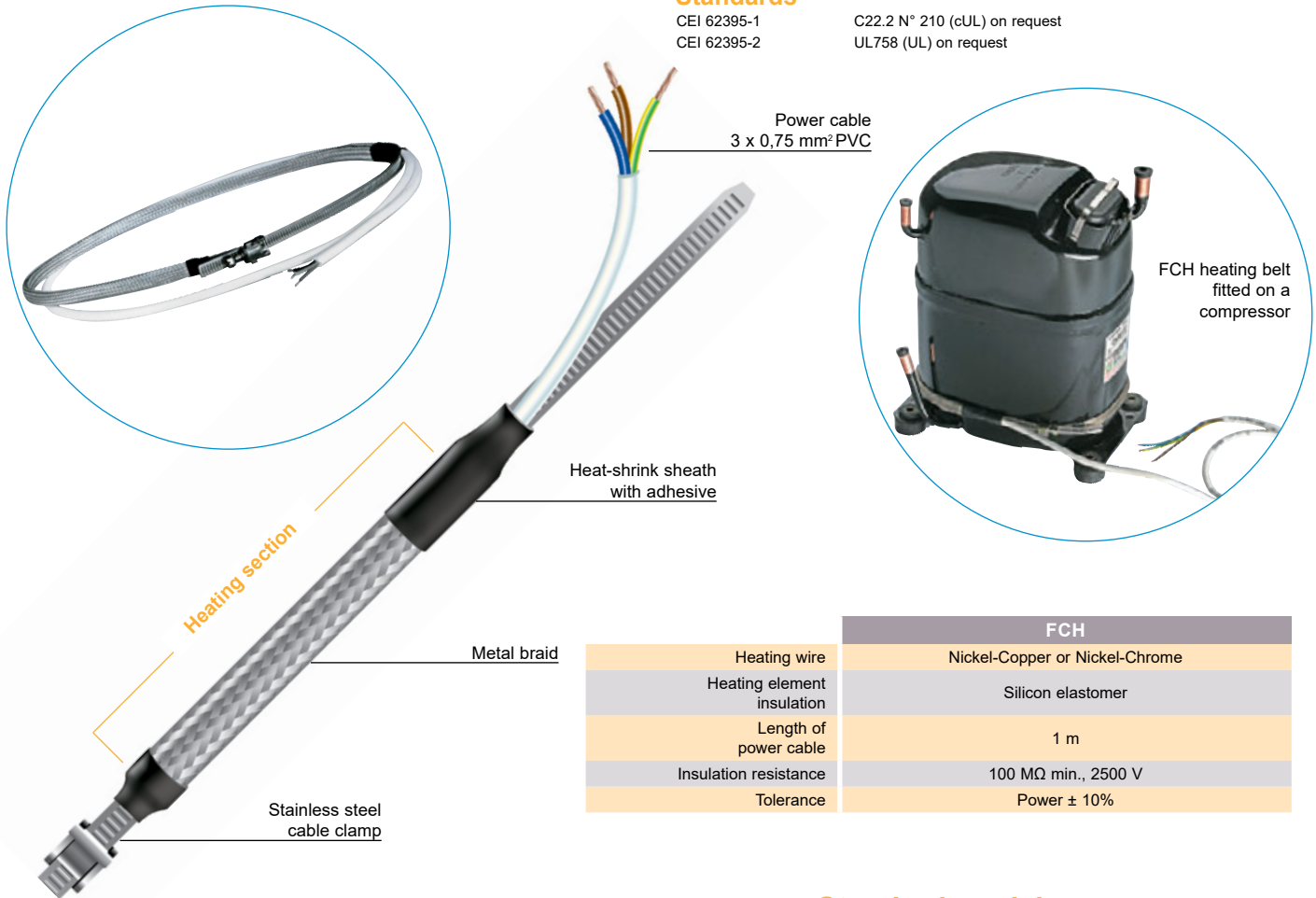

	FCH
Heating wire	Nickel-Copper or Nickel-Chrome
Heating element insulation	Silicon elastomer
Length of power cable	1 m
Insulation resistance	100 MΩ min., 2500 V
Tolerance	Power ± 10%

### Standard models

	FCH-10	FCH-20	FCH-30	FCH-40	FCH-50	FCH-60
Power (W)	35	40	45	55	65	75
Min. clamping Ø (mm)	120	140	150	180	220	245
Max. clamping Ø (mm)	175	175	280	280	320	370

### Use

Heating belts are series resistors. Consult the pages of the catalogue devoted to the corresponding general operating principles, general instructions for use and accessories.

**FLEXELEC S.A.S**  
 10, rue des frères Lumière  
 Z.A. du Bois Rond  
 69720 ST BONNET DE MURE - FRANCE  
 Tél : + 33 (0)4.72.48.30.90  
 E-mail : flexelec@omerin.com

**FLEXELEC Dept**  
 OMERIN ASIA Pte Ltd  
 51 Goldhill Plaza #08-11  
 SINGAPORE 308900  
 Tel : + 65 6255 4778  
 Fax : + 65 6255 4779  
 E-mail : sales@omerin.com.sg

**FLEXELEC (UK) Ltd**  
 Unit 11 Kings Park Industrial Estate  
 Primrose Hill - KINGS LANGLEY  
 Hertfordshire - WD4 8ST - UK  
 Tel : + 44 (0) 1923.274477  
 Fax : + 44 (0) 1923.270264  
 E-mail : sales@omerin.co.uk

**FLEXELEC Dept**  
 OMERIN GmbH  
 Buchwiese 16  
 D-65510 IDSTEIN - GERMANY  
 Tel : + 49 (0) 6126.94.31-0  
 Fax : + 49 (0) 6126.83.999  
 E-mail : omeringmbh@omerin.com

## TEMPERATURE MAINTENANCE SYSTEMS

# FCHK

## Heating belts for refrigeration compressors with integrated thermostat



### Characteristics

- Quick, safe and easy to fit.
- Sealed silicon insulated heating element.
- Metal braid for earthing.
- Voltage 230 V as standard.
- Integrated thermostat.
- Patented product.
- Special production on request.
- Ingress protection code : IP54

### Applications

FCHK heating belts are fitted to refrigerating compressors to prevent the coolant from being absorbed by the oil.

The lower the temperature, the quicker and the more complete the absorption, which can seriously damage the compressor, especially when starting up, through lack of lubrication.

The integrated thermostat on the crankcase heater makes it completely autonomous.

### Standards

CEI 62395-1  
CEI 62395-2

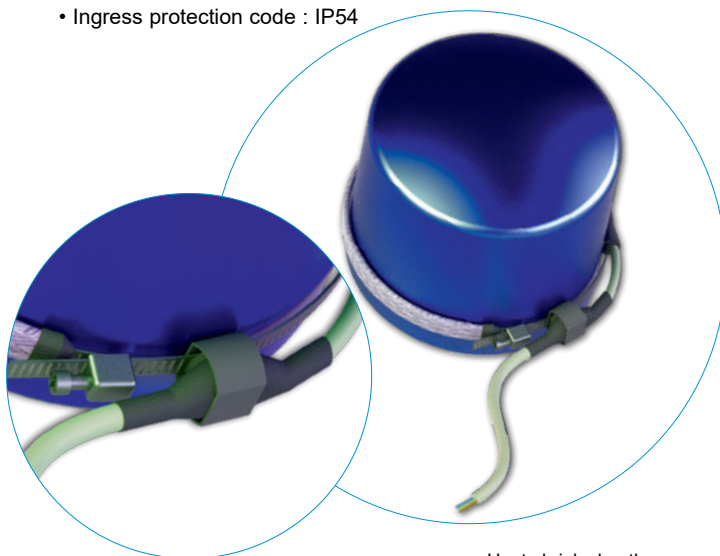

Heat-shrink sheath with adhesive

Thermostat

Power cable  
3x0.75 mm<sup>2</sup> PVC

Stainless steel cable clamp

Heating section with metal braid



FCHK heating belt fitted on a compressor

	FCHK
Heating wire	Nickel-Copper or Nickel-Chrome
Heating element insulation	Silicon elastomer
Length of power cable	1 m
Insulation resistance	100 MΩ min., 2500 V
Tolerance	Power ± 10%
Thermostat	Temperature on request

### Standard models

	FCHK-10	FCHK-20	FCHK-30	FCHK-40	FCHK-50	FCHK-60
Power (W)	35	40	45	55	65	75
Min. clamping Ø (mm)	145	165	175	205	245	270
Max. clamping Ø (mm)	175	175	280	280	320	370

### Use

Heating belts are series resistors. Consult the pages of the catalogue devoted to the corresponding general operating principles, general instructions for use and accessories.

#### FLEXELEC S.A.S

10, rue des frères Lumière  
Z.A. du Bois Rond  
69720 ST BONNET DE MURE - FRANCE  
Tél : + 33 (0)4.72.48.30.90

E-mail : flexelec@omerin.com

#### FLEXELEC Dept

OMERIN ASIA Pte Ltd  
51 Goldhill Plaza #08-11  
SINGAPORE 308900  
Tel : + 65 6255.4778  
Fax : + 65 6255.4779  
E-mail : sales@omerin.com.sg

#### FLEXELEC (UK) Ltd

Unit 11 Kings Park Industrial Estate  
Primrose Hill - KINGS LANGLEY  
Hertfordshire - WD4 8ST - UK  
Tel : + 44 (0) 1923.274477  
Fax : + 44 (0) 1923.270264  
E-mail : sales@omerin.co.uk

#### FLEXELEC Dept

OMERIN GmbH  
Buchwiese 16  
D-65510 IDSTEIN - GERMANY  
Tel : + 49 (0) 6126.94.31-0  
Fax : + 49 (0) 6126.83.999  
E-mail : omeringmbh@omerin.com

# Flexible heating cables and elements temperature maintenance systems



## **FLEXMAT®**

### HEATING MATS

A	ALUMINIUM HEATER MATS	75
T - TA - TV - TP	SILICON ELASTOMER HEATER MATS	76 - 77

**TEMPERATURE MAINTENANCE SYSTEMS**



**A Aluminium heater mats**

**Characteristics**

- Takes up little space.
- Highly flexible.
- Rectangular shapes.
- Quick and easy to fit.
- Any voltage on request.
- mats on request.
- Length of power cable : 1 m as standard.
- Special production on request.
- Ingress protection code : IP54

**Applications**

Aluminium heater mats are used in many cases where large surfaces are to be heated and the power required is relatively low, for protecting against freezing or maintaining at temperatures up to + 80°C.

To ensure that these heating elements enjoy a long service life, we recommend using a control device.

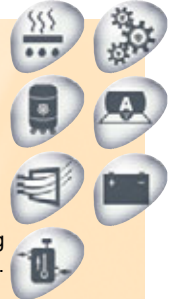

**Standards**

- CEI 62395-1
- CEI 62395-2
- C22.2 N° 210 (cUL) on request
- UL758 (UL) on request

**Notes :**

- Options
- CLASS II insulation
  - Temperature limit device.
  - Cut-outs.
  - Aluminium foil can be earthed.

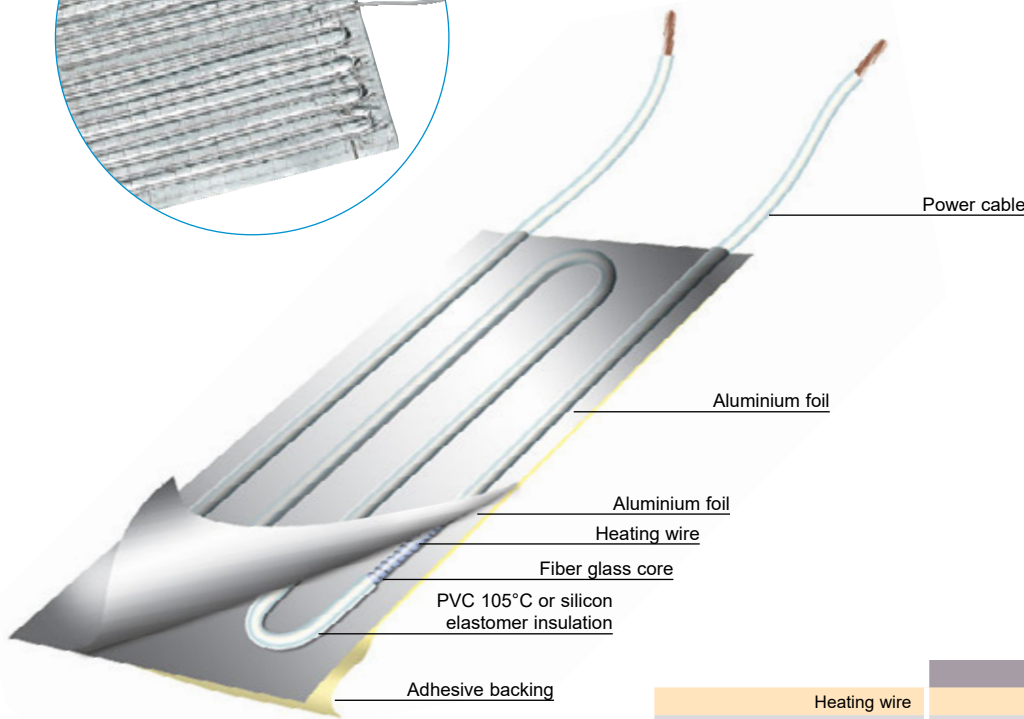
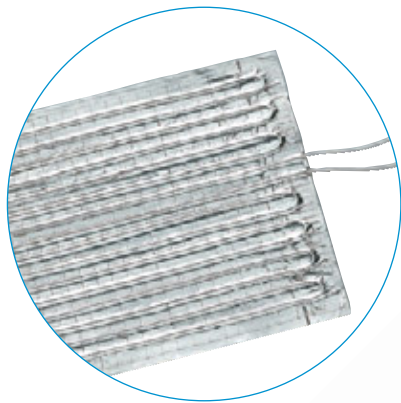

	Aluminium plates
Heating wire	Nickel-Copper or Nickel-Chrome
Max.surface	1.5 m <sup>2</sup>
Max.length	3 m
Max. width	1 m
Thickness	~ 3 mm (thicker at connection point)
Max. power	0.25 W/cm <sup>2</sup>
Permissible surface temperature	from - 60°C to + 110°C
Max. maintenance temperature	+ 80°C
Tolerance	Power ± 10%

**Use**

Consult the pages of the catalogue devoted to the corresponding general operating principles, general instructions for use and accessories.

## TEMPERATURE MAINTENANCE SYSTEMS

## T - TA - TV - TP

### Silicon elastomer heater mats



### Characteristics

- Takes up little space.
- Highly flexible.
- A variety of shapes.
- Quick and easy to fit.
- Any voltage on request.
- Length of power cable : 1 m as standard.
- T : silicon elastomer insulated mats.
- TA : with adhesive back for permanent fitting.
- TV : factory vulcanised on metal backing.
- TP : factory preformed version.
- Special production on request.
- **EN 45545** certification on request.
- Ingress protection code : IP53 (others on request).



### Applications

Military: radars, missiles, temperature maintenance of electronic circuits or protective housings anti-condensation for aiming devices, etc.

Office equipment: photocopiers, printers.

Rolling stock: rear-view mirrors, batteries, vehicle floors, driving cabs for locomotives, locks, tank wagons, etc.

Food service industry: electric hot-plates, double boilers, trays, etc.

Photography: developing and fixing trays.

Medical: X-rays, trays for wax impressions, apparatus for bacteria cultures or blood tests, transformation of cosmetic products, etc.

Various industries: substances in drums, heating trays, distillers, boilers, ultrasound vessels, tanks for electrolysis, process tanks, storage silos and vats, hoppers, conveyor belts, control desks, presses, repair kits for composite materials, etc.

Miscellaneous: photoelectric cells, decomposition toilets, various drying devices, etc.

To ensure that these heating elements enjoy a long service life, we recommend using a control device.



### Standards

CEI 62395-1  
CEI 62395-2

NF EN 45545-2 on request  
NF EN 60077-1 on request  
NF EN 60077-2 on request

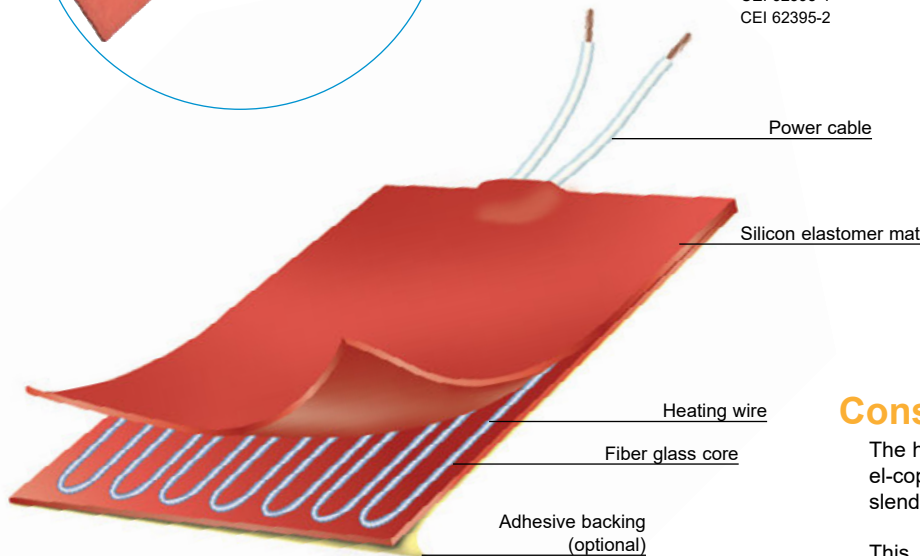

### Constitution

The heating part is made up of a nickel-chrome or nickel-copper alloy heating wire wound in a spiral around a slender fiber glass core.

This heating element is then placed between two layers of woven fiber glass impregnated with silicon elastomer.

This material is an excellent electrical insulator (approx. 12 kV/mm), a good conductor of heat (7.10-4 W/cm/K) and flexible. It can withstand continuous temperatures of around 200°C. The fiber glass weave endows the assembly with good mechanical resistance, while allowing it to remain very flexible.

### Use

Consult the pages of the catalogue devoted to the corresponding general operating principles, general instructions for use and accessories.

#### FLEXELEC S.A.S

10, rue des frères Lumière  
Z.A. du Bois Rond  
69720 ST BONNET DE MURE - FRANCE  
Tél : + 33 (0)4.72.48.30.90

E-mail : flexelec@omerin.com

#### FLEXELEC Dept

OMERIN ASIA Pte Ltd  
51 Goldhill Plaza #08-11  
SINGAPORE 308900  
Tel : + 65 6255.4778  
Fax : + 65 6255.4779  
E-mail : sales@omerin.com.sg

#### FLEXELEC (UK) Ltd

Unit 11 Kings Park Industrial Estate  
Primrose Hill - KINGS LANGLEY  
Hertfordshire - WD4 8ST - UK  
Tel : + 44 (0) 1923.274477  
Fax : + 44 (0) 1923.270264  
E-mail : sales@omerin.co.uk

#### FLEXELEC Dept

OMERIN GmbH  
Buchwiese 16  
D-65510 IDSTEIN - GERMANY  
Tel : + 49 (0) 6126.94.31-0  
Fax : + 49 (0) 6126.83.999  
E-mail : omeringmbh@omerin.com

**TEMPERATURE MAINTENANCE SYSTEMS**

**T - TA - TV - TP  
Silicon elastomer heater mats**



Heating mats are manufactured to order and their sizes and shapes can be adapted to each situation.

They can be fixed using eyelets or hooks incorporated into the heating mat and, in some cases, vulcanized directly by us onto your metal parts. An adhesive backing can also be provided.

Other options such as double insulation, fuses, thermal cut-out devices or temperature sensors (PT100, PT1000, thermocouple,...) are available.

T - TA - TV - TP	
Heating wire	Nickel-Copper or Nickel-Chrome
Heating element insulation	Silicon elastomer
Max. surface	1.5 m <sup>2</sup>
Max. length	3 m
Max. width	1 m
Thickness	~ 3 mm (thicker at connection point)
Max. power	0.5 W/cm <sup>2</sup>
Permissible surface temperature	From - 60°C to + 200°C
Max. temperature maintenance	+ 160°C
Tolerance	Power ± 10%

**Surface temperature according to power**

Power W/cm <sup>2</sup>	Surface temperature (°C)
0.05	50
0.10	70
0.15	90
0.20	110
0.25	130
0.30	145
0.35	160
0.40	175
0.45	190
0.50	205
0.55	215
0.60	230
0.70	250
0.80	265
0.90	280
1.00	290

For information, silicon elastomer will rapidly degrade beyond these values.

The above table gives surface temperatures for heating mats according to their power level in W/cm<sup>2</sup>, measured in the following conditions:

Heating mats placed on a 1.5mm thick horizontal aluminium plate in a calm atmosphere at +20°C. The plate is suspended in the air. Temperatures are recorded after stabilising.

**Use**

Consult the pages of the catalogue devoted to the corresponding general operating principles, general instructions for use and accessories.

Flexible heating cables and elements  
temperature maintenance systems



**FLEXPLATE®**

HEATING PLATES

## TEMPERATURE MAINTENANCE SYSTEMS



### PLA Heating plates

#### Characteristics

- Easy to fit.
- Stands up well to the climatic, physical and chemical conditions encountered in the railway environment.
- Special production on request.

#### Applications

Heating plates are specially designed for protecting railway switches from freezing.

They are fixed by means of stainless steel clips.

Several plates can be connected in series (15 maximum). Connections between plates are made by means of tubular connectors and heat-shrink sheaths.

To ensure that these heating elements enjoy a long service life, we recommend using a control device.



#### Standards

CEI 62395-1  
CEI 62395-2

NF EN 60077-1  
NF EN 60077-2

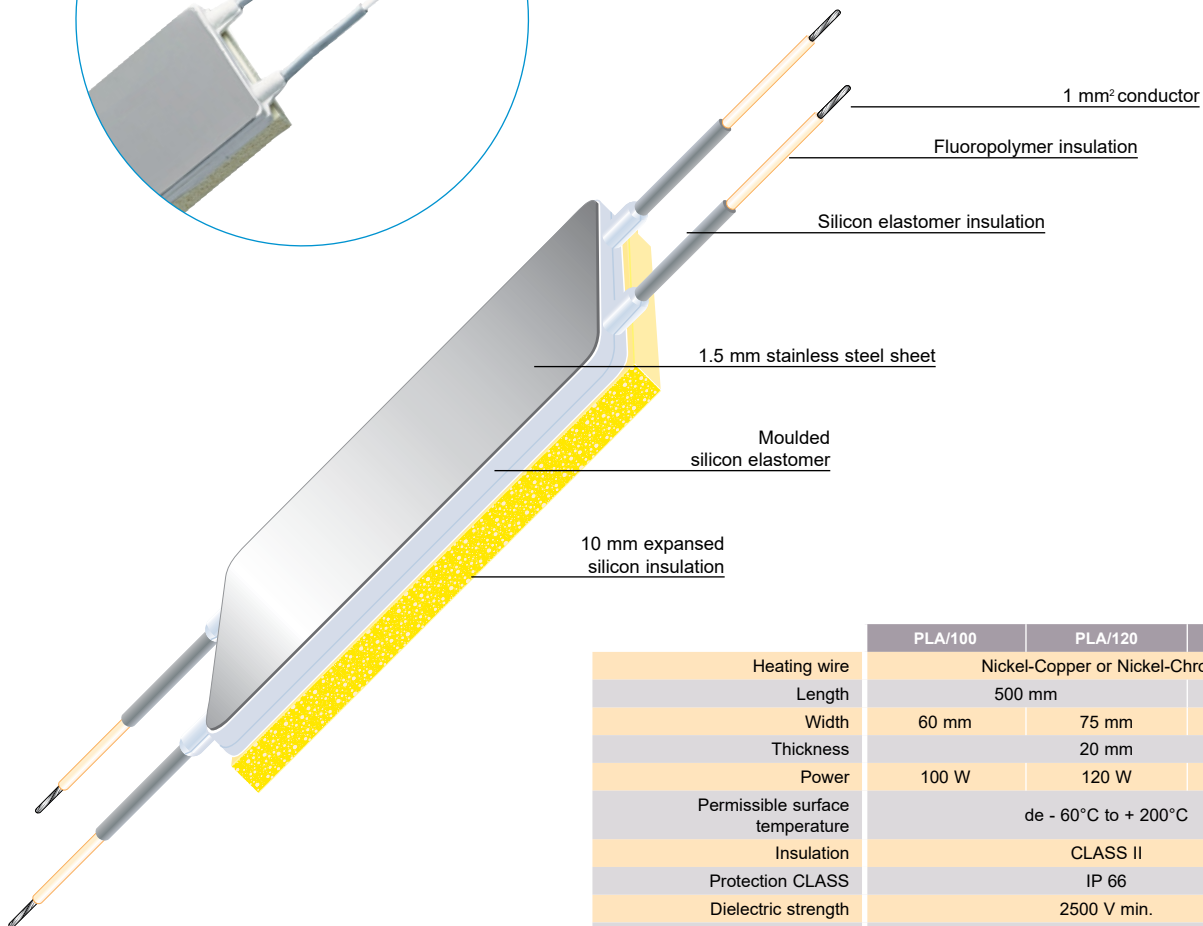
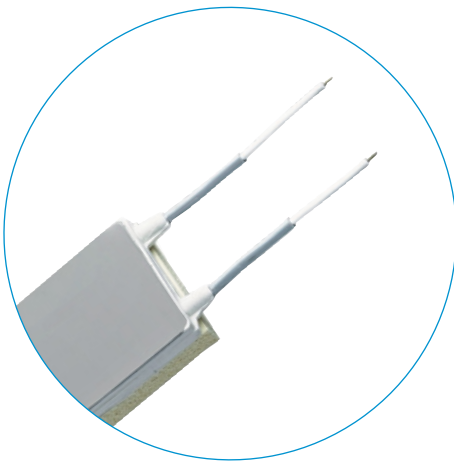

	PLA/100	PLA/120	PLA/200
Heating wire	Nickel-Copper or Nickel-Chrome		
Length	500 mm		
Width	60 mm	75 mm	110 mm
Thickness	20 mm		
Power	100 W	120 W	200 W
Permissible surface temperature	de - 60°C to + 200°C		
Insulation	CLASS II		
Protection CLASS	IP 66		
Dielectric strength	2500 V min.		
Insulation resistance	100 MΩ min.		
Weight	Approx. 1 kg		

#### Use

Consult the pages of the catalogue devoted to the corresponding general operating principles, general instructions for use and accessories.

#### FLEXELEC S.A.S

10, rue des frères Lumière  
Z.A. du Bois Rond  
69720 ST BONNET DE MURE - FRANCE  
Tél : + 33 (0)4.72.48.30.90  
E-mail : flexelec@omerin.com

#### FLEXELEC Dept

OMERIN ASIA Pte Ltd  
51 Goldhill Plaza #08-11  
SINGAPORE 308900  
Tel : + 65 6255.4778  
Fax : + 65 6255.4779  
E-mail : sales@omerin.com.sg

#### FLEXELEC (UK) Ltd

Unit 11 Kings Park Industrial Estate  
Primrose Hill - KINGS LANGLEY  
Hertfordshire - WD4 8ST - UK  
Tel : + 44 (0) 1923.274477  
Fax : + 44 (0) 1923.270264  
E-mail : sales@omerin.co.uk

#### FLEXELEC Dept

OMERIN GmbH  
Buchwiese 16  
D-65510 IDSTEIN - GERMANY  
Tel : + 49 (0) 6126.94.31-0  
Fax : + 49 (0) 6126.83.999  
E-mail : omeringmbh@omerin.com



Flexible heating cables and elements  
temperature maintenance systems



**FLEXDRUM®**

**DRUM HEATERS**

## TEMPERATURE MAINTENANCE SYSTEMS

## TCF - TCF/TV

### Silicon elastomer insulated drum heaters



### Characteristics

- Silicon elastomer insulated heating mats.
- Damp-proof and splash-proof.
- Double insulation.
- Power supply: 230 V as standard.
- Fixed by means of hooks and a stainless steel spring.
- If an accurate temperature is necessary, use either a thermometer or a thermostat immersed in the liquid.
- TCF : Silicon elastomer insulated drum heater without thermostat.
- TCF/TV : with adjustable thermostat graduated from 0 to 11 (approx + 20°C to + 150°C).
- Ingress protection code : TCF IP55, TCF/TV IP54.



TCF

The graphs show the increase in temperature of a 200 liter drum filled with a liquid of density 1 and specific heat 1 Kcal/kg.°C



TCF/TV

### Applications

TCF and TCF/TV drum heaters are specially designed to heat the contents of drums of 30, 60, 120 and 200 liter capacity from around the outside.

They are recommended for obtaining relatively low temperatures with a fairly long heating time, or for maintaining medium temperatures.

A typical example is heating fluids to reduce their viscosity ready for pumping or transfer operations: glucose, honey, fat, wax and oil.

To reach the required temperature more quickly, drums can be heated or maintained at temperature with 1, 2 or 3 drum-heaters.

To ensure that these heating elements enjoy a long service life, we recommend using a control device, especially for TCF drum-heaters.



### Standards

CEI 62395-1 CEI 62395-2

### Temperature increase with time

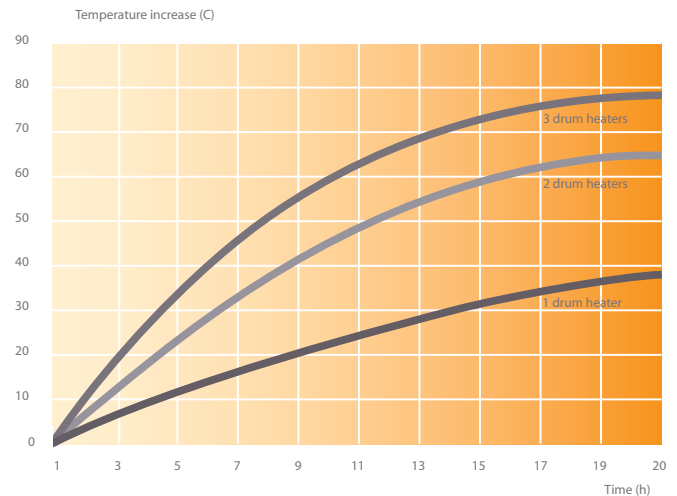

	TCF/300 TCF/TV/300	TCF/500 TCF/TV/500	TCF/750 TCF/TV/750	TCF/1000 TCF/TV/1000
Heating element	Nickel-Copper or Nickel-Chrome heating wire			
Heating wire insulation	Silicon elastomer			
Second insulation	Fiber glass mat impregnated with silicon elastomer			
Length of heating section	770 mm	935 mm	1280 mm	1660 mm
Width	150 mm			
Drum diameter (± 10 mm)	296 mm	350 mm	460 mm	580 mm
Standard capacity (as a guide)	30 L	60 L	120 L	200 L
Power	300 W	500 W	750 W	1000 W
Voltage	230 V			
Permissible surface temperature	up to + 200°C			
Length of power cable	2 m			

### Use

Consult the pages of the catalogue devoted to the corresponding general operating principles, general instructions for use and accessories.

#### FLEXELEC S.A.S

10, rue des frères Lumière  
Z.A. du Bois Rond  
69720 ST BONNET DE MURE - FRANCE  
Tél : + 33 (0)4.72.48.30.90

E-mail : flexelec@omerin.com

#### FLEXELEC Dept

OMERIN ASIA Pte Ltd  
51 Goldhill Plaza #08-11  
SINGAPORE 308900  
Tel : + 65 6255.4778  
Fax : + 65 6255.4779  
E-mail : sales@omerin.com.sg

#### FLEXELEC (UK) Ltd

Unit 11 Kings Park Industrial Estate  
Primrose Hill - KINGS LANGLEY  
Hertfordshire - WD4 8ST - UK  
Tel : + 44 (0) 1923.274477  
Fax : + 44 (0) 1923.270264  
E-mail : sales@omerin.co.uk

#### FLEXELEC Dept

OMERIN GmbH  
Buchwiese 16  
D-65510 IDSTEIN - GERMANY  
Tel : + 49 (0) 6126.94.31-0  
Fax : + 49 (0) 6126.83.999  
E-mail : omeringmbh@omerin.com

# Flexible heating cables and elements temperature maintenance systems

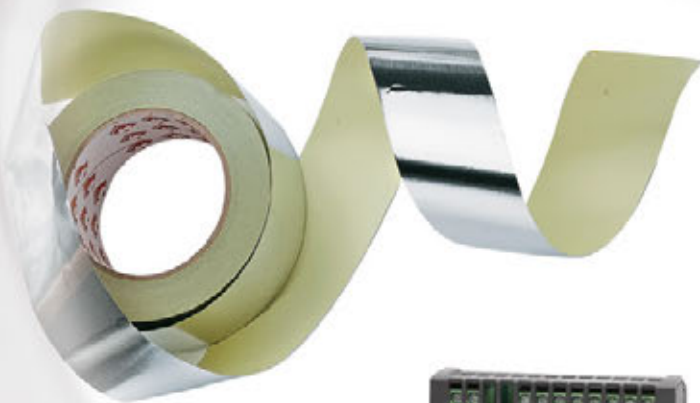

## FLEXKIT®

## ACCESSORIES

TERMINATION	CONNECTION KITS	83
MOUNTING	FITTING ACCESSORIES	84
FX/AT2 - FX/AT - FX/ST	THERMOSTATS	85
FX/TM3	ELECTRONIC THERMOSTATS	86
FX/CDM2	HYGROTHERMOSTATS	87
FX/CDM3	HYGROTHERMOSTATS	88
FX/DC1P	POWER MODULATORS	89

## TEMPERATURE MAINTENANCE SYSTEMS

### Connection kits

ITEM	SAFE AREAS															HAZARDOUS AREAS							
	FS/KIT	FS/KIT5	FS/KIT7	FS/KIT9T	FS/KIT11P	FS/KIT15/TP	FS/KITX	FS/KITXF	FS/KITIC	FT/KITC	FT/KIT1	FT/KIT15	FT/KIT0-1	FT/KIT0-5	FT/KIT1G	FT/KIT5G	FT/KITX-1	FT/KITX-5	on request	FS/KITEX3	FS/KITEX4	Z0112012	
FSH2/TP																							
FSJ																							
FSO																							
FST																							
FSJ/T																							
FSO/T																							
FST/T																							
FST/I																							
FSJ/TP																							
FSO/TP																							
FST/TP																							
FST/TF																							
FSX																							
FSX/T																							
FSX/I																							
FSX/TF																							
FTSM																							
FTSM/T																							
FTC																							
FTP																							
FTP/T																							
FTP/I																							
FTP/TP																							
FTP0																							
FTP0/T																							
FTSH																							
FTSH/T																							
FTSH/I																							
FTSH/TF																							
FTSH/TS																							
FTS0																							
FTS0/T																							
FTS0/TS																							
FTS3/IF																							
FTS3/IS																							
FTTH																							
FTTH/T																							
FTTH/I																							
FTTH/TF																							
FTX1																							
C1FS/I																							
C2FS/I																							
C3FS/I																							
ZFE CGE																							
ZFA CGA																							

For use in gutters

## TEMPERATURE MAINTENANCE SYSTEMS

## Fitting accessories

**FX/JB**

Junction box 85 x 85 x 45mm – IP 55 (IP 65 fitted with FX/G) – 7 entries 20 mm for the connection or derivation of heating cables.

**FX/JBG**

Junction box 98 x 98 x 61mm – IP 55 (IP65 if equipped with the FLEXKIT FS/KIT/...) - 7 entries 5 mm. For the connection or derivation of heating cables : FSTTP, FSX, FSXT, FSXI, FSXTF.

**FX/BOITIER/2**

Junction box IP 65 (195 x 195 x 110 mm) for FX/CDM2, FX/CDM3 hydrothermostat, FX/DC1P power modulator, FX/TM3 thermostat.

**FX/PBY**

Pipe bracket with bending strip and screws for FLEXKIT FX/JB junction box or FLEXKIT FX/AT2 thermostat.

**FX/PBA**

Pipe bracket for FLEXKIT FX/AT, FX/BOITIER/2, FX/JB,FX/JBG, FX/JBE2, FX/ST.

**SILT 25**

Tube of silicon sealant 25 g

**SILT 100**

Tube of silicon sealant 100 g

**Caps P**

Silicon end-piece for FTP/FTTH

**Caps G**

Silicon end-piece for FTSH

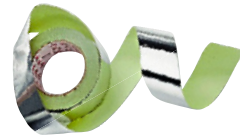
**FTAL**

Aluminium adhesive tape. 50 mm wide, 50 m long

**FX/G**

Cable gland 20 mm

**FX/GX**

Cable gland for FTX1 cable

**FX/ETIQ**

Self-adhesive "ELECTRICAL HEAT TRACING" label

**FX/JBE2**

ATEX EEx "e" IIC – T6 junction box with 4 M20 outputs and 2 caps

**FX/CRT**

Hook to hold cable in place for drain pipe

**KYCY/FIXATION**

Box of 25 m metal fixing strip

**FIXATION/INOX**

Box of 25 m stainless steel fixing strip.

**FLEXELEC S.A.S**

10, rue des frères Lumière  
Z.A. du Bois Rond  
69720 ST BONNET DE MURE - FRANCE  
Tél : + 33 (0)4.72.48.30.90

E-mail : flexelec@omerin.com

**FLEXELEC Dept**

OMERIN ASIA Pte Ltd  
51 Goldhill Plaza #08-11  
SINGAPORE 308900  
Tel : + 65 6255 4778  
Fax : + 65 6255 4779  
E-mail : sales@omerin.com.sg

**FLEXELEC (UK) Ltd**

Unit 11 Kings Park Industrial Estate  
Primrose Hill - KINGS LANGLEY  
Hertfordshire - WD4 8ST - UK  
Tel : + 44 (0) 1923.274477  
Fax : + 44 (0) 1923.270264  
E-mail : sales@omerin.co.uk

**FLEXELEC Dept**

OMERIN GmbH  
Buchwiese 16  
D-65510 IDSTEIN - GERMANY  
Tel : + 49 (0) 6126.94.31-0  
Fax : + 49 (0) 6126.83.999  
E-mail : omeringmbh@omerin.com

## TEMPERATURE MAINTENANCE SYSTEMS

## FX/AT2 - FX/AT - FX/ST Thermostats



FX/AT2 thermostat



FX/AT thermostat



FX/ST thermostat



### Applications

In order to maintain the right temperature, a control device will provide the following advantages:

- the heating element is energised only when necessary.
- the heating element lifetime is increased.
- the heating element will not overheat.
- the energy consumed is kept to a minimum.

#### FX/AT2 ambient thermostat

To protect vessels and piping from freezing, this thermostat is preset at + 3°C.

#### FX/AT ambient thermostat

To protect vessels and piping from freezing, this thermostat can be set from - 5°C to + 40°C.

#### FX/ST bulb thermostat and capillary tube

The stainless steel bulb and capillary tube allow the temperature at the surface of the vessel or the piping to be read. Three temperature ranges from - 5°C to + 220°C (see below).

### Standards

CEI 62395-2

	FX/AT2 ambient thermostat	FX/AT ambient thermostat
Temperature range	preset to + 3°C	- 5°C to + 40°C
Current rating	5 A	16 A
Box protection level	IP 65	IP 65
Box dimensions	80 x 80 x 45 mm	125 x 125 x 75 mm
Accuracy	± 3°C	± 2.5°C
Differential	5°C	2.5°C
Connection	2 inputs with cable gland	
Voltage	220 V / 240 V	

	FX/ST - 40	FX/ST - 120	FX/ST - 220
Temperature range	- 5°C to + 40°C	+ 20°C to + 120°C	+ 20°C to + 220°C
Accuracy	+ 4°C at + 40°C	+ 5°C at + 120°C	+ 10°C at + 220°C
Differential	2.5°C	5°C	7°C
Capillary tube length	1.2 m		
Bulb dimensions	155 mm x 0.6 mm	86 mm x 0.6 mm	211 mm x 0.3 mm
Max. bulb temperature	+ 77°C	+ 202°C	+ 262°C
Bulb and capillary tube material	Stainless steel		
Current rating	16 A		
Box material	Polycarbonate		
Protection level	IP 65		
Box dimensions	175 x 125 x 75 mm		
Max. box temperature	+ 50°C		
Voltage	220 V / 240 V		

### Use

Consult the pages of the catalogue devoted to the corresponding general operating principles, general instructions for use and accessories.

#### FLEXELEC S.A.S

10, rue des frères Lumière  
Z.A. du Bois Rond  
69720 ST BONNET DE MURE - FRANCE  
Tél : + 33 (0)4.72.48.30.90

E-mail : flexelec@omerin.com

#### FLEXELEC Dept

OMERIN ASIA Pte Ltd  
51 Goldhill Plaza #08-11  
SINGAPORE 308900  
Tel : + 65 6255.4778  
Fax : + 65 6255.4779  
E-mail : sales@omerin.com.sg

#### FLEXELEC (UK) Ltd

Unit 11 Kings Park Industrial Estate  
Primrose Hill - KINGS LANGLEY  
Hertfordshire - WD4 8ST - UK  
Tel : + 44 (0) 1923.274477  
Fax : + 44 (0) 1923.270264  
E-mail : sales@omerin.co.uk

#### FLEXELEC Dept

OMERIN GmbH  
Buchwiese 16  
D-65510 IDSTEIN - GERMANY  
Tel : + 49 (0) 6126.94.31-0  
Fax : + 49 (0) 6126.83.999  
E-mail : omeringmbh@omerin.com

## TEMPERATURE MAINTENANCE SYSTEMS



### FX/TM3

## Electronic thermostats with double digital display

### Characteristics

- Current rating 8 A (resistive) by changeover contact.
- Power supply from 100 to 240 V - 50/60 Hz.
- Accuracy +/- 1% of temperature range.
- Dimensions 70 x 87 x 61 mm, 4 DIN modules.
- Double temperature display (value and setup) at +/- 1°C.
- Adjustable differential from 1 to 30°C.
- Thermostat is fitted to a DIN rail (omega 3)
- The sensor can be extended and positioned 50m away from the thermostat (cable not included)
- Alarm up and down via free contact, current rating 8 A (resistive)
- Exposure temperature -5 to +55°C.
- Screw terminals for conductors up to 2,5mm<sup>2</sup>.

#### Thermostat FX/TM3/140

- Temperature range: from - 5°C to + 140°C.
- PTC sensor.
- Sensor length: 3 m ( can be extended up to 50m with 2x1.5mm<sup>2</sup> cable).

#### Thermostat FX/TM3/200

- Temperature range: from - 5°C to + 200°C.
- PT100 sensor.
- Sensor length: 3 m( can be extended up to 50m with 3x1.5mm<sup>2</sup> cable).



### Applications

The range of FX/TM3 electronic thermostats allow precise control of temperatures.

To maintain a desired temperature of the pipes, tank or other container and their contents, a control device provides the following advantages:

- the heating element is energised only when necessary.
- the heating element lifetime is increased.
- the heating element will not overheat.
- the energy consumed is kept to a minimum.

The FX/TM3 thermostat is fitted to a DIN rail (omega3) in an electrical cabinet or waterproof electrical junction box.

### Standards

CEI 62395-2

### Electrical connection diagram

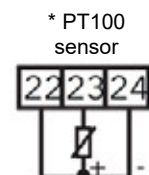
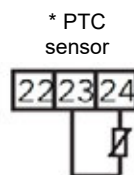
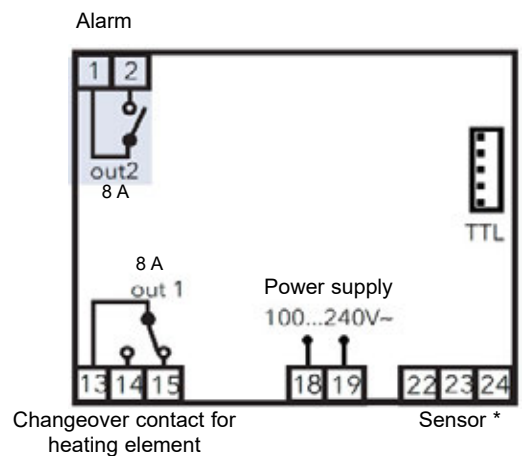

### Use

Consult the pages of the catalogue devoted to the corresponding general operating principles, general instructions for use and accessories.

#### FLEXELEC S.A.S

10, rue des frères Lumière  
Z.A. du Bois Rond  
69720 ST BONNET DE MURE - FRANCE  
Tél : + 33 (0)4.72.48.30.90

E-mail : flexelec@omerin.com

#### FLEXELEC Dept

OMERIN ASIA Pte Ltd  
51 Goldhill Plaza #08-11  
SINGAPORE 308900  
Tel : + 65 6255 4778  
Fax : + 65 6255 4779  
E-mail : sales@omerin.com.sg

#### FLEXELEC (UK) Ltd

Unit 11 Kings Park Industrial Estate  
Primrose Hill - KINGS LANGLEY  
Hertfordshire - WD4 8ST - UK  
Tel : + 44 (0) 1923.274477  
Fax : + 44 (0) 1923.270264  
E-mail : sales@omerin.co.uk

#### FLEXELEC Dept

OMERIN GmbH  
Buchwiese 16  
D-65510 IDSTEIN - GERMANY  
Tel : + 49 (0) 6126.94.31-0  
Fax : + 49 (0) 6126.83.999  
E-mail : omeringmbh@omerin.com

## TEMPERATURE MAINTENANCE SYSTEMS

## FX/CDM2 Hygrothermostat



### Characteristics

Electronic regulator **FX/CDM2** :

- Power supply 230 V +/- 10%, 50/60 Hz.
- Current rating 16 A.
- Fit on DIN rail.
- Dimensions: 86 x 52 x 59 mm (3 modules).
- Ingress protection code IP20.
- Temperature range preset from 0 to +10°C.
- Heating time preset from 1 to 5 hours.
- Ambient temperature : -10 to +50°C.

For others characteristics, refer to instructions given with the product.

FX/CDM2



FX/CDM2/TEMP



FX/CDM2/NEIGE



FX/CDM2/PARK



FX/BOITIER/2



Option **FX/BOITIER/2**

- Box IP 65 (195 x 195 x 110 mm) for hygrothermostat

### Applications

The **FX/CDM2** hygrothermostat permanently checks for the presence of snow or black ice in gutters or access ramps...

The heating cables are powered according to the outside temperature and the presence of humidity.

The energy required is calculated by an interval timer switch.

This regulator is particularly adapted for small installations and ensure an energy saving.

Usefull for gutter ice protection:

**FX/CDM2 + FX/CDM2/TEMP + FX/CDM2/NEIGE**

Usefull for access ramps ice protection:

**FX/CDM2 + FX/CDM2/TEMP + FX/CDM2/PARK**

### Standards

CEI 62395-2

NF P 52-302-1 + annex A1

NF P 52-302-2 (DTU 65.7)

External temperature sensor **FX/CDM2/TEMP** :

- Dimensions: box 86X45X35 mm, wall fixation.
- Power supply: By standard 2x1.5mm<sup>2</sup> conductor cable,(not supplied) from the electronic box to the sensor terminals (50 m maximum).

Humidity sensor **FX/CDM2/NEIGE** :

- Use in case of ice protection of roof or gutter
- Dimensions of the box: 105 x 30 x 13 mm.
- Ingress protection code IP68.
- Power supply by conductor cable (10m long, can be extended up to 50 m with 6x1.5mm<sup>2</sup> conductor).
- The sensor is automatically heated to transform snow into humidity.

Humidity sensor **FX/CDM2/PARK** :

- Use in case of ice protection of access ramps.
- Dimensions Diam. 60 mm high 32mm.
- Ingress protection code IP68.
- Power supply by conductor cable (10m long, can be extended up to 50 m with 6x1.5mm<sup>2</sup> conductor).
- The sensor is automatically heated to transform snow into humidity.

### Connection diagram

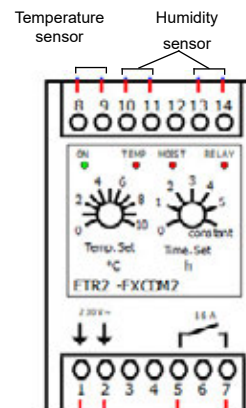

#### FLEXELEC S.A.S

10, rue des frères Lumière  
Z.A. du Bois Rond  
69720 ST BONNET DE MURE - FRANCE  
Tél : + 33 (0)4.72.48.30.90

E-mail : flexelec@omerin.com

#### FLEXELEC Dept

OMERIN ASIA Pte Ltd  
51 Goldhill Plaza #08-11  
SINGAPORE 308900  
Tel : + 65 6255.4778  
Fax : + 65 6255.4779

E-mail : sales@omerin.com.sg

#### FLEXELEC (UK) Ltd

Unit 11 Kings Park Industrial Estate  
Primrose Hill - KINGS LANGLEY  
Hertfordshire - WD4 8ST - UK  
Tel : + 44 (0) 1923.274477  
Fax : + 44 (0) 1923.270264

E-mail : sales@omerin.co.uk

#### FLEXELEC Dept

OMERIN GmbH  
Buchwiese 16  
D-65510 IDSTEIN - GERMANY  
Tel : + 49 (0) 6126.94.31-0  
Fax : + 49 (0) 6126.83.999

E-mail : omeringmbh@omerin.com



## TEMPERATURE MAINTENANCE SYSTEMS

# FX/CDM3 Hygrothermostat



### Characteristics

Electronic regulator with digital display **FX/CDM3**

- Power supply 230 V +/- 10%, 50/60 Hz.
  - Current rating 16 A.
  - Fit on DIN rail.
  - Dimensions: 106 x 90 x 58 mm (6 modules).
  - Ingress protection code IP20.
  - LCD display 2 lines of 16 characters.
  - 3 adjustment buttons: MENU / VALUE / ENTER.
  - Temperature range preset from 0 to +6°C.
  - After run time preset from 10 min to 24 hours.
  - Temperature unit in °C or °F.
  - Operating time counter.
  - Switching contact for alarm messages 230v - 2A.
  - Ambient temperature: -20 to +50°C.
  - Alarm messages on display.
  - Program menu available in following languages: Deutsch, English, Français, Suomi, Svenska, Cesky, Dutch, Magyar, Italiano, Turkce and Polski.
- For others characteristics, refer to instructions given with the product.

FX/CDM3



FX/CDM3/TEMP



FX/CDM3/NEIGE



FX/CDM3/PARK



FX/BOITIER/2



Option **FX/BOITIER/2**

- Box IP 65 (195 x 195 x 110 mm) for hygrothermostat.

### Applications

The **FX/CDM3** hygrothermostat is used to control permanently the presence of snow or black ice in gutters or access ramps, parking...

The heating cables are powered according to the outside temperature and the presence of humidity.

The energy required is calculated by an interval timer switch.

This regulator is particularly adapted for installations which need a precise management of energy.

Equipped with a switching contact for alarm messages, it allows a permanent control of your installations.

Use for freeze protection of gutter:

**FX/CDM3 + FX/CDM3/TEMP + FX/CDM3/NEIGE**

Use for freeze protection of access ramps:

**FX/CDM3 + FX/CDM3/TEMP + FX/CDM3/PARK**

### Standards

CEI 62395-2

NF P 52-302-1 + annex A1

NF P 52-302-2 (DTU 65.7)

External temperature sensor **FX/CDM3/TEMP** :

- Dimensions: Dia. 9 mm, length 35 mm, wall fixation
- Power cable of 4m (can be extended up to 50 m with 2x1.5mm<sup>2</sup> cable).

Humidity sensor **FX/CDM3/NEIGE** :

- Use for freeze protection for roof and gutter.
- Dimensions: box 225 x 108 x 13 mm.
- Ingress protection code IP68.
- Length of conductor cable 4 m (can be extended up to 50 m with 5x1.5mm<sup>2</sup> cable).
- The sensor is automatically heated to transform snow into humidity.

Humidity sensor **FX/CDM3/PARK** :

- Use for freeze protection for of access ramps.
- Dimensions: Dia. 70 mm / high 40mm.
- Ingress protection code IP68.
- Power supply by 15m long cable (can be extended up to 50 m with 5x1.5mm<sup>2</sup> cable)
- The sensor is automatically heated to transform snow into humidity.

### Connection diagram

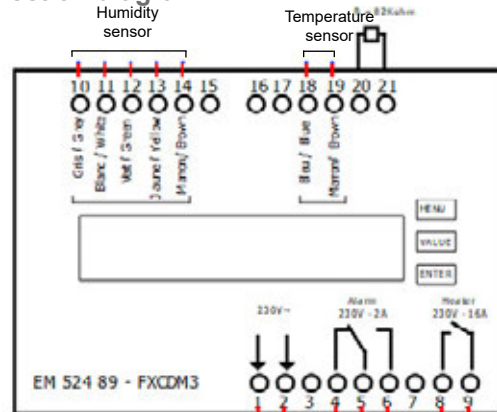

#### FLEXELEC S.A.S

10, rue des frères Lumière  
 Z.A. du Bois Rond  
 69720 ST BONNET DE MURE - FRANCE  
 Tél : + 33 (0)4.72.48.30.90

E-mail : flexelec@omerin.com

#### FLEXELEC Dept

OMERIN ASIA Pte Ltd  
 51 Goldhill Plaza #08-11  
 SINGAPORE 308900  
 Tel : + 65 6255 4778  
 Fax : + 65 6255 4779

E-mail : sales@omerin.com.sg

#### FLEXELEC (UK) Ltd

Unit 11 Kings Park Industrial Estate  
 Primrose Hill - KINGS LANGLEY  
 Hertfordshire - WD4 8ST - UK  
 Tel : + 44 (0) 1923.274477  
 Fax : + 44 (0) 1923.270264

E-mail : sales@omerin.co.uk

#### FLEXELEC Dept

OMERIN GmbH  
 Buchwiese 16  
 D-65510 IDSTEIN - GERMANY  
 Tel : + 49 (0) 6126.94.31-0  
 Fax : + 49 (0) 6126.83.999

E-mail : omeringmbh@omerin.com

## TEMPERATURE MAINTENANCE SYSTEMS

### FX/DC1P Power modulators



#### Characteristics

- Principle: Analogue chrono-proportional.
- Setting: Percentage 0 to 100 %.
- Time base: 30 seconds fixed.
- Power supply: 230 V ± 10 %.
- Output : 230 V, 20 A maximum.
- Dimensions : 87 x 55 x 55 mm.
- Fit on DIN rail.



#### Schematic diagram

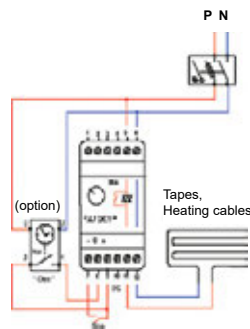

#### Applications

The FX/DC1P power modulator is used to adjust the power of an installation to the real need.

It is particularly suited for heating cables used in hot water networks.

#### Operation

The power can be set from 0 to 100 %.

Power is modified by limiting the power supply time to the cable in a 30 second cycle.

Two controls are used to force the cycle to 100 % (impulse) or to 0 % (stop). For hot water, the sterilise function can be obtained with an external timer (option).

#### Option FX/BOITIER/2

The power modulator can be fitted in an IP 65 (195 x 195 x 110 mm).

#### External timer option FX/HOR

- Weekly programm
- Programming in 2 h segments
- Output: 16 A rated contact
- Vertical analogue face
- Power reserve 100 h
- Dimensions: 1 x 17.5 mm module

#### Setting the modulator according to the power required

Use the FSH/TP 30 self-adjusting heating tape. The tables below give heat losses in W/m, and the modulator setting (the figure in brackets) for straight heat tracing along the piping. This setting is given as a guide only and must be adjusted according to the results obtained. For the sterilise function, please consult us.

Vertical risers Ambient temperature : 15°C Insulation 0.042 W/m.°C								
Nominal diameter Ext. diameter (mm)	1/2"	3/4"	1"	1 1/4"	1 1/2"	2"	2 1/2"	3"
	21	27	34	42	48	60	76	89
Maintenance temperature 45°C								
Thermal lagging th. mm								
9	14.07 (70)	17.05 (85)						
13	10.81 (55)	12.91 (65)	15.33 (80)	18.07 (90)				
19	8.43 (45)	9.91 (50)	11.61 (60)	13.52 (70)	14.93 (75)	17.75 (90)		
32	6.23 (30)	7.17 (35)	8.23 (40)	9.41 (50)	10.28 (50)	12.00 (60)	14.25 (70)	16.07 (80)
Maintenance temperature 50°C								
9	16.41 (90)							
13	12.61 (70)	15.06 (80)						
19	9.84 (55)	11.56 (65)	13.54 (75)	15.77 (85)				
32	7.27 (40)	8.36 (45)	9.60 (50)	10.97 (60)	11.99 (65)	14.00 (75)	16.63 (90)	
Maintenance temperature 55°C								
9								
13	14.41 (85)							
19	11.24 (65)	13.22 (80)	15.48 (90)					
32	8.30 (50)	9.56 (55)	10.97 (65)	12.54 (75)	13.70 (80)	15.99 (95)		
Basement Aera Ambient temperature: 5°C Insulation 0.036 W/mK								
Nominal diameter Ext. diameter (mm)	1/2"	3/4"	1"	1 1/4"	1 1/2"	2"	2 1/2"	3"
	21	27	34	42	48	60	76	89
Maintenance temperature 45°C								
Thermal lagging th. mm								
25	8.17 (40)	9.50 (50)	11.00 (55)	12.69 (65)	13.94 (70)	16.42 (80)		
30	7.37 (35)	8.51 (45)	9.79 (50)	11.22 (55)	12.27 (60)	14.36 (70)	17.10 (85)	
40	6.34 (30)	7.23 (35)	8.23 (40)	9.33 (45)	10.15 (50)	11.75 (60)	13.84 (70)	15.52 (80)
50	5.68 (30)	6.43 (35)	7.26 (35)	8.17 (40)	8.84 (45)	10.15 (50)	11.85 (60)	13.22 (65)
Maintenance temperature 50°C								
25	9.19 (50)	10.68 (60)	12.38 (70)	14.28 (80)	15.69 (85)			
30	8.29 (45)	9.57 (50)	11.01 (60)	12.62 (70)	13.81 (75)	16.15 (90)		
40	7.13 (40)	8.13 (45)	9.25 (50)	10.50 (60)	11.42 (60)	13.21 (70)	15.57 (85)	
50	6.39 (35)	7.23 (40)	8.16 (45)	9.19 (50)	9.94 (55)	11.42 (60)	13.33 (75)	14.87 (80)

# GENERAL INSTALLATION

AND INSTRUCTIONS FOR USE OF ALL FLEXELEC PRODUCTS



## BASIC RULES

Persons involved in the installation and testing of electrical trace heating systems shall be suitably trained in all special techniques required. Installations are intended to be carried out under the supervision of a qualified person. Your temperature maintenance system will give trouble-free operation provided it is fitted in accordance with good engineering practice. You should fit and connect up the cables and flexible heating elements as indicated below. Read the instructions carefully: it will be more costly to have to carry out repair work afterwards than to "waste" time reading these instructions to the end and installing your system in keeping with the recommendations given. It is prohibited to use the system in any way that does not respect the precautions for use. Before beginning to fit the heating element, make sure that thermal insulation is fitted immediately afterwards: our products could be damaged by tools or solder, etc. falling on them if too much time elapses between these two operations.

### Warning :

In no event should the heating element be held in the air or enclosed within insulating material while it is operating.  
Do not energise the heating element before fitting it.  
Do not immerse the heating element.  
Do not fit the heating element if it is damaged.  
Do not touch the heating element when it is energised.

Assembly and commissioning are subject to standards (BS 6351 Part3), safety instructions and accident prevention rules in force in each country. **It is prohibited to modify the devices in any way.**

Clean and wipe the outside of the part to be heated. Also check that no sharp parts such as welds, welding flash, metal parts, etc. could damage the heating element. The whole of the heating element must be in contact with the part to be heated. In no circumstances should the heating element cross over or overlap itself. Cover the whole of the heating element and the part to be heated with thermal insulation of recommended thickness. Stick the warning label on the thermal insulation. The heating element should be energised only when fitting operations are finished. Connect up to a suitable, properly protected electric power supply. The electrical protection systems (fuses, circuit-breakers, etc.) must be provided on the site as per the applicable standards in force.

## SPECIAL INSTRUCTIONS

Ensure that the flexible heating element chosen is fully appropriate for the requirements of the installation. For this purpose, consult the FLEXELEC technical documents. Check whether the project requires straight or spiral heat tracing and if extra lengths need to be provided for valves, flanges, pumps, etc. Heat loss calculations for flanges, valves, piping supports or other elements may turn out to be complex because of difficulty in measuring the exact heat transfer surfaces. Many accessories such as flanges and valves are manufactured according to standards, while others, such as filters or pumps differ from one manufacturer or application to another. To determine heat losses, follow the recommendations below:

Type	Diameter	Equivalent cable length
Flanges	≤ DN 200	0.3 m
	> DN 200	1.0 m
Valves	≤ DN 200	1.0 m
	> DN 200	3.0 m

**Notes :** The extra length of cable calculated in these 4 cases may not be used in full for practical reasons. All constant poPower cables or self-regulating heating tapes have maximum circuit lengths depending on their power rating and voltage. Consult the FLEXELEC technical documentation.

When fitting heating elements, do not:

- allow them to come into contact with sharp edges,
- apply excessive pulling force to them,
- allow them to be crushed in any way.

The cables must be terminated as soon as possible after fitting to prevent damp entering by non-sealed ends.

- Inspect the heating elements and accessories as soon as you receive them to check that they have not been damaged during transit. It is recommended to carry out measurement of insulation resistance at this stage.
- For constant poPower cables, check that sufficient length has been provided to allow for the incorporated cold tails.
- Allow an extra 0.5 m of self-regulating heating cable to connect to another cable or for a branch joint.
- Always begin heat tracing at the power supply end.

In the case of an installation in an explosive atmosphere, please read carefully paragraph "INSTALLATION IN ATEX OR EXPLOSIVE ATMOSPHERE AREA".

## FITTING THERMOSTATS AND JUNCTION BOXES

To protect against freezing, air thermostats are generally used. These must be fitted in the area most exposed to freezing and can be fixed to the piping or any other support. If they are fitted to piping the heating cable can be connected directly into the thermostat. Self-regulating heating cables can be connected directly to a junction box (a thermostat is not strictly necessary, but strongly recommended). Supports exist for fixing the junction box or thermostat onto the piping. Bulb and capillary or temperature probe thermostats are normally used for production lines to control the surface temperature and must be fitted immediately adjacent to the power point. Supports exist for fixing the thermostat onto the piping.

First fix the thermostats and junction boxes in the planned locations. For bulb thermostats, the bulb must always be fixed as shown below:

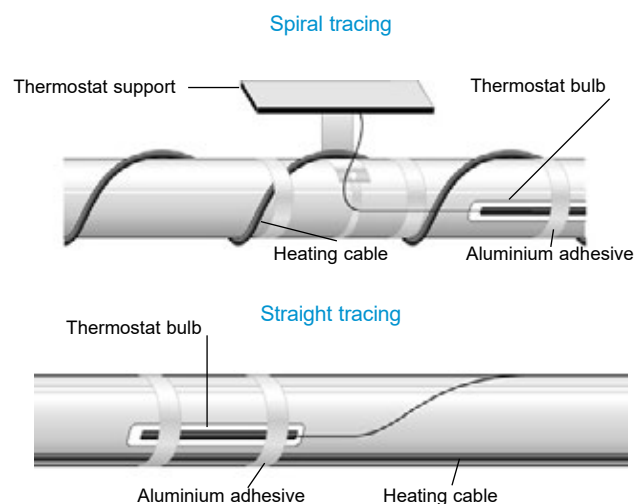

# INSTRUCTIONS

(the term "cables" also refers to other flexible heating elements).

The first rule is never to cross heating cables or lay one on top of another.

It is not essential to completely cover the heating element with aluminium adhesive, but this is recommended for the following reasons:

- The heating cable will not be trapped in the thermal insulation.
- Thermal efficiency will be improved through better contact between the heating cable and the piping.
- This eliminates the risk of hot spots on the heating cable.
- This type of fitting is strongly recommended on flanges, valves, taps, etc.

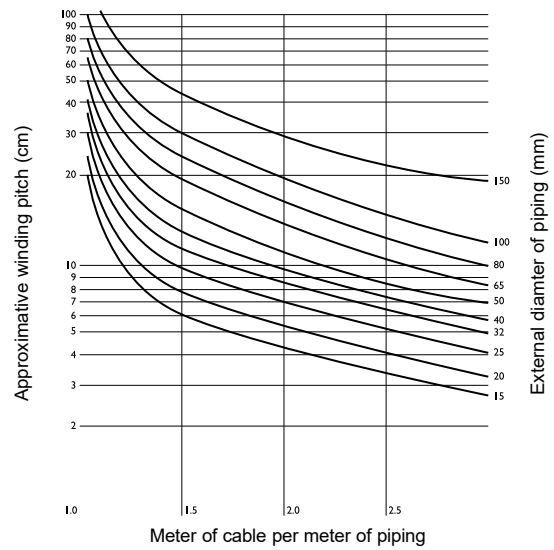
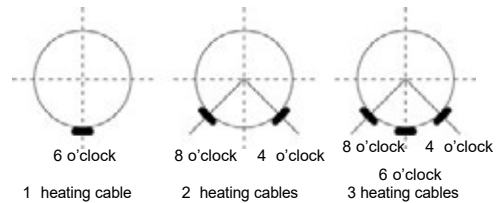

## Straight tracing

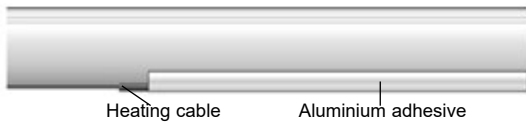

## Spiral tracing

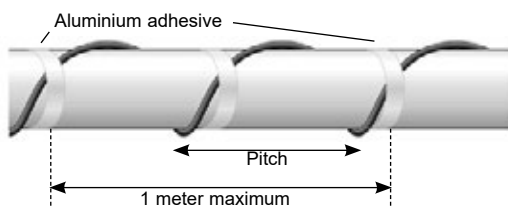

## TRACING PIPING EQUIPMENT: ELBOWS, FLANGES, VALVES AND PIPING SUPPORTS

- Notes :**
- Inverting the screw pitch either side of the equipment makes it easier to remove.
  - Ensure that the heating cable is properly in contact with the equipment.
  - Smooth over any sharp edges as necessary (with an aluminium tape, for example).

Type	Straight tracing	Spiral tracing
Elbows	 Trace on the outside of the elbow	 Regular pitch, adjacent turns must not touch on the inside
Flanges		
Small diameter valves		
Large diameter valves		

## PIPING SUPPORTS

Type	Straight tracing	Spiral tracing
Screwed collars		
Welded flat iron bars		
Welded columns		

## TRACING A BRANCH JOINT

Branch joints or nozzles are often of a smaller diameter than the main pipe. Return tracing must therefore be avoided on long nozzles as these would increase the installed power to the point of multiplying it by two (straight tracing) and causing local overheating.

Short nozzles: 1.5 m maximum.

Long nozzles: greater than 1.5 m.

For long nozzles, break the circuit and fit a junction box to allow the heating circuit to branch off.

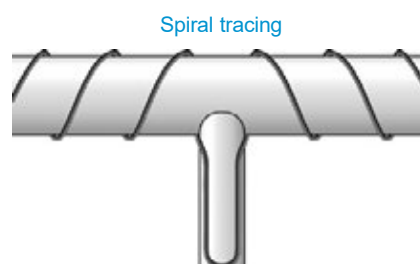

## FITTING A HEATING CABLE TO PIPING WITH A STEAM TRACER

Check that the cable sheath will withstand the temperature of the steam.

Never use spiral tracing, which would cause the cable to come into contact with the steam tracer.

Use single or double straight tracing.

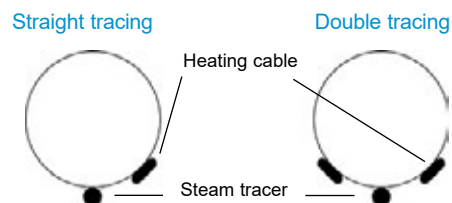

## TRACING TWO PIPES SIDE BY SIDE

Never spiral the heating cable over the piping.

Use double straight tracing.

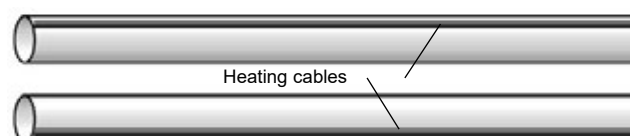

Before fitting the thermal insulation, perform the following inspections:

- Throughout the cable installation process.
- As soon as possible once the installation is finished and before connecting up to the electric power supply.
- If applicable, check that the metal sheath, braid, screen or equivalent electrically conductive covering of the trace heater is connected to an earth terminal.

### Installation inspection

The following inspections must be made:

- The heating cables and temperature probes (if any) are in close contact with the piping; there is no air gap between these devices and the piping.
- No cable loops are hanging in mid air.
- No heating cable is trapped under piping supports, thermostat supports or junction boxes, etc.
- No heating cable is crossed over or laid on top of another, or twisted about itself.
- All the heating cables are fixed to the piping with appropriate fixing materials.

### Circuit continuity and insulation resistance inspection

The following procedure is designed to check that the various heating cables are operating properly.

- Constant power cables

- 1 Check the resistance and continuity of the circuits using a multimeter.
- 2 Check the insulation resistance between the conductors and the earth using a 2500 V DC (500V DC min) megohmmeter.

Whatever the length of the cable, the minimum insulation resistance must be 10 megohms.

- 3 The results of the above tests must be recorded and stored.

- Self-regulating heating cables

Check the insulation resistance using a 2500 V DC (500V DC min) megohmmeter. Whatever the length of the cable, the minimum insulation resistance must be 10 megohms. (in case of ATEX area the minimum value should be 20 megohms)

- 1 Between conductors and piping if the cable is not braided.
- 2 Between conductors and braid if any.
- 3 For cables with braid and sheath, perform 2 tests:
  - Test 1: between conductor and braid,
  - Test 2: between braid and metal piping
- 4 As before, record and store the test results.

## MAINTENANCE

### Visual inspection

Visually inspect the piping with tracers to check that neither the insulation nor the cable have been damaged.

### Tracer inspection

The following inspection procedures must be carried out at least once a year (before winter) for installations protecting against freezing or twice a year for production installations.

### Thermal insulation

- The heating cables must always be protected by thermal insulation.
- During inspection operations, be very careful not to damage the heating cables.
- The thermal insulation must always have the same temperature limit as the heating cables.
- The heating cables must never be trapped within the thermal insulation.
- The thermal insulation must be appropriate for the environmental conditions prevailing.
- Apply labels warning that electrical heat tracing is in use on the outside of the thermal insulation at intervals which make it possible for them to be seen clearly, wherever the person working on the piping may be. Do not forget to place them on both sides of the thermal insulation.

### Repair / Modification / Trouble shooting / Others issues

In case you do not find the appropriate information, please contact the technical service on [www.flexelec.com](http://www.flexelec.com).

### Before any inspection work, switch off the electric power supply

- Remove the lid from junction boxes and thermostats. • Disconnect the heating cable from the electric power supply.
- Check, as described above, the insulation resistance rating and, for constant power cables, the resistance rating. Make a note of these figures and store them.
- Compare these figures with those from the previous inspection. If they are the same, reconnect the heating cable and replace the junction box lids.
- With the thermostat still electrically insulated, carry out the inspection as above. Check that the power cables are properly connected to the right terminal block. Using a multimeter, check that the thermostat cuts off power to the heating cables by lowering and raising the temperature setpoint to minimum and then to maximum.
- If the thermostat operates, do not forget to put the setpoint back to the initial temperature.
- Replace the thermostat lid.
- Visually inspect the installation in order to detect any damage to piping or insulation.

## INSTALLATION IN ATEX OR EXPLOSIVE ATMOSPHERE AREA

In case of installation of ATEX products, the following conditions are imperative:

- The personnel involved in the installation and controls must have the appropriate qualification.
- Use the products and accessories in line with the installation requirement.
- The equipment must be certified and suitable for the installation area.
- Documents must be kept for the entire life of the product.

# PIPING QUESTIONNAIRES

THESE QUESTIONNAIRES ARE INTENDED TO HELP YOU TO CHOOSE THE RIGHT PRODUCT



## A Temperature maintenance

Temperature maintenance is the operation which aims to keep the temperature of a device constant. This implies that the products and their containments must already be at this same temperature.

If this is not the case, then the application comprises a heating dimension, and part B of the questionnaire must also be completed.

Temperature to be maintained  °C

Min. ambient temperature  °C

Nominal Diameter  mm OR outside diameter of the piping  mm

Length of piping  m

Piping material   
*The material that the piping is made of is important information since it will influence the choice of power rating of the cable or braid.*

Max. surface temperature of the piping  °C  
*The max. temperature of the piping is sometimes a decisive criterion, for example if there are high temperature steam cleaning cycles*

Type of substance being conveyed   
*This is important, as it must be ensured that, in the event of leakage the insulation of the heating cable will not be chemically attacked.*

Thickness of the insulation  mm

Type of insulation

Thermal conductivity of the insulation  W/m.K

Max. temperature acceptable for the insulation  °C

Available voltage  V

Safe area  OR ATEX hazardous area   
*(indicate the temperature class)*

Network geometry: nozzles, "T", any diagram

Others   
*flanges, pumps, valves, max. or min. temperature acceptable by the fluid, etc...*

PHOTOCOPIY - FILL IN - FAX with your name, address, phone n°, email

## B Heating

Heating may be static or involve a flow.

Fluid density  kg/dm<sup>3</sup>

Specific heat of the fluid  kJ/kg.K

Initial temperature  °C

Temperature to be reached  °C

Min. ambient temperature  °C

Time allowed for heating  h

Fluid flow rate  kg/h

Inside diameter  mm OR Piping thickness  mm

Specific heat of the piping material  kJ/kg.K

# VESSEL - HOPPER QUESTIONNAIRES

THESE QUESTIONNAIRES ARE INTENDED TO HELP YOU TO CHOOSE THE RIGHT PRODUCT



## A Temperature maintenance

Temperature maintenance is the operation which aims to keep the temperature of a device constant. This implies that the products and their containments must already be at this same temperature.

If this is not the case, then the application comprises a heating dimension, and part B of the questionnaire must also be completed.

Temperature to be maintained	<input type="text"/>	°C
Min. ambient temperature	<input type="text"/>	°C
Outside diameter of the vessel or dimension of the edges if rectangular	<input type="text"/>	mm
Height or length of the vessel	<input type="text"/>	mm
Cylindrical height available for tracing	<input type="text"/>	mm
Bottom: flat, rounded, etc.	<input type="text"/>	
Feet: number, insulation, etc.	<input type="text"/>	
Vessel material <small>The material that the vessel is made of is important information since it will influence the choice of power rating of the cable or braid</small>	<input type="text"/>	
Max. surface temperature of the vessel <small>The max. temperature of the vessel can be a decisive criterion, for example if there are steam cleaning cycles.</small>	<input type="text"/>	°C
Type of substance contained <small>This is important, as it must be ensured that, in the event of leakage, the insulation of the heating cable will not be chemically attacked.</small>	<input type="text"/>	
Thickness of the insulating lagging	<input type="text"/>	mm
Type of insulating lagging	<input type="text"/>	
Thermal conductivity of the insulation	<input type="text"/>	W/m.K
Max. temperature acceptable for the insulation	<input type="text"/>	°C
Available voltage	<input type="text"/>	V
Safe area	OR	ATEX hazardous area <small>(indicate the temperature class)</small>
<input type="text"/>		
Obstacle on the surface of the vessel: nozzles, feet, ... any diagrams	<input type="text"/>	
Other <small>flanges, pumps, valves, max. or min. temperature acceptable by the fluid, etc....</small>	<input type="text"/>	

PHOTOCOPIY - FILL IN - FAX with your name, address, phone n°, email

## B Heating

Heating may be static or involve a flow.

Fluid density	<input type="text"/>	kg/dm <sup>3</sup>
Specific heat of the fluid	<input type="text"/>	kJ/kg.K
Initial temperature	<input type="text"/>	°C
Temperature to be reached	<input type="text"/>	°C
Min. ambient temperature	<input type="text"/>	°C
Time allowed for heating	<input type="text"/>	h
Fluid flow rate	<input type="text"/>	kg/h
Max. vessel capacity	<input type="text"/>	kg or m <sup>3</sup>
Max. fill rate	<input type="text"/>	%
Vessel thickness	<input type="text"/>	mm
Specific heat of the vessel material	<input type="text"/>	kJ/kg.K



# PRODUCTS QUESTIONNAIRES

IN ORDER TO DETERMINE A SPECIAL PRODUCT MADE TO THE MEASUREMENTS YOU REQUIRE, ANSWERS TO THE FOLLOWING QUESTIONS ARE NECESSARY. THESE WILL BE USED TO DEFINE THE BEST PRODUCT FOR YOUR NEEDS.



## A Cords

Linear ohmic value	<input type="text"/>	ohm/m
Type of insulation <i>PVC/Silicon elastomer/Fluoropolymer</i>	<input type="text"/>	
Outside diameter	<input type="text"/>	mm
<b>OR</b>		
Final circuit length	<input type="text"/>	m
Power	<input type="text"/>	W
Voltage	<input type="text"/>	V
Type of insulation <i>PVC/Silicon elastomer/Fluoropolymer</i>	<input type="text"/>	

## B Cables - Tapes

Total length	<input type="text"/>	mm
Heating length	<input type="text"/>	mm
Power	<input type="text"/>	W
Voltage	<input type="text"/>	V
Nature of insulation	<input type="text"/>	
Braid	<input type="text"/>	
Braid material <i>tinned copper, stainless steel, glass silk</i>	<input type="text"/>	
Outside diameter	<input type="text"/>	mm
Number of power cables	<input type="text"/>	1 or 2
Length of power cables	<input type="text"/>	mm
Type of insulation for the connection between heating and cold part(s) <i>(sleeving, moulding, etc.)</i>	<input type="text"/>	
Other	<input type="text"/>	

## C Mats

Length	<input type="text"/>	mm
Width	<input type="text"/>	mm
Other geometry details <i>diagram and dimensions</i>	<input type="text"/>	
Power	<input type="text"/>	W
Voltage	<input type="text"/>	V
Power cable length	<input type="text"/>	mm
Location of power cable <i>diagram and dimensions</i>	<input type="text"/>	

### OPTIONS

Adhesive surface for permanent fitting <i>(YES / NO)</i>	<input type="text"/>
Type of removable fitting <i>Hook + spring / Velcro / Eyelets + silicon tape</i>	<input type="text"/>
Location for thermostat sensor <i>(YES : state diameter / NO)</i>	<input type="text"/>
Temperature limiter <i>(60°C / 80°C / 150°C / NO)</i>	<input type="text"/>
PT 100, J Thermocouple <i>(YES / NO)</i>	<input type="text"/>
Location of options <i>diagram and dimensions</i>	<input type="text"/>

## D Hoses

There are so many different types of pipe that these questions are only a basis to help us define the product. Please contact us to provide us with more complete information.

Nominal inside diameter <i>standard : maximum = 25 mm</i>	<input type="text"/>	mm
Total hose length	<input type="text"/>	m
Operating temperature	<input type="text"/>	°C
Max. operating temperature	<input type="text"/>	°C
Voltage	<input type="text"/>	V
Power	<input type="text"/>	W
Sensor type <i>(P = PT 100, N = NiCr-Ni or F = Fe-CuNi)</i>	<input type="text"/>	
Max. pressure	<input type="text"/>	bar
Type de connections	<input type="text"/>	
Other	<input type="text"/>	

PHOTOCOPY - FILL IN - FAX with your name, address, phone n°, email

**FLEXELEC S.A.S**  
10, rue des frères Lumière  
Z.A. du Bois Rond  
69720 ST BONNET DE MURE - FRANCE  
Tel : + 33 (0)4.72.48.30.90  
Fax : + 33 (0)4.78.40.82.81  
E-mail : flexelec@omerin.com

**FLEXELEC Dept**  
OMERIN ASIA Pte Ltd  
51 Goldhill Plaza #08-12/01  
SINGAPORE 308900  
Tel : + 65 6255.4778  
Fax : + 65 6255.4779  
E-mail : sales@omerin.com.sg

**FLEXELEC (UK) Ltd**  
Unit 11 Kings Park Industrial Estate  
Primrose Hill - KINGS LANGLEY  
Hertfordshire - WD4 8ST - UK  
Tel : + 44 (0) 1923.274477  
Fax : + 44 (0) 1923.270264  
E-mail : sales@omerin.co.uk

**FLEXELEC Dept**  
OMERIN GmbH  
Bushwiese 16  
D-65510 IDSTEIN - GERMANY  
Tel : + 49 (0) 6126.94.31-0  
Fax : + 49 (0) 6126.83.999  
E-mail : omeringmbh@omerin.com

# TECHNICAL GUIDE

# OPERATING PRINCIPLES



## CONSTANT POWER CABLES

A constant power cable is a succession of identical resistors R connected in parallel, which makes it possible to have the same power dissipation on each of these sections.

These resistors are made up of a heating wire coiled around insulated conductor cables, with which it comes into contact at each contact point. These sections, between 2 consecutive contact points, are known as modules.

This is why the cable can only heat between 2 contact points, as shown in the following diagram:

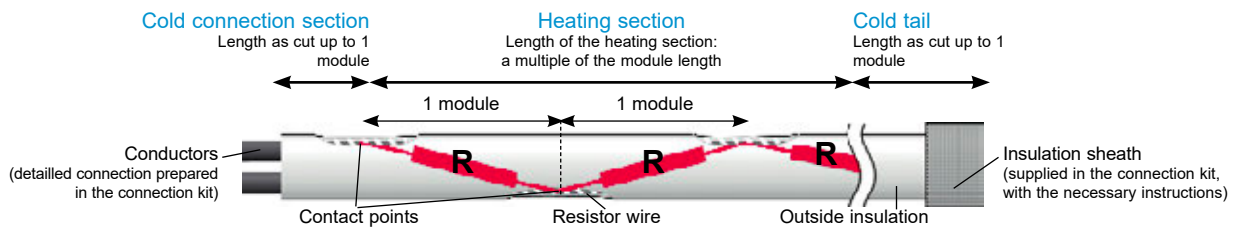

## SELF-REGULATING CABLES

Between the conductors, the dark material which makes up the heating element is a polymer enriched with carbon as a conductor. The resistivity of this material varies with temperature because of the dilation of the internal structures which reduce the space available for the current to pass.

Consequently, when the temperature rises, the power dissipated by the cable decreases. This is the phenomenon referred to as self-regulation. This prevents overheating which could damage the cable and allows the part of the cable placed in a colder environment to produce more energy in that zone.

When in operation, the cable will therefore always reach a balance between the power it dissipates and the losses due to the outside environment. However, it is impossible to accurately determine at what temperature the surface of the cable will stabilise, because of the complexity and variability of its environment. Similarly, in order to keep control over the installation and to make significant energy savings, it is always recommended to adjust these cables by means of a thermostat.

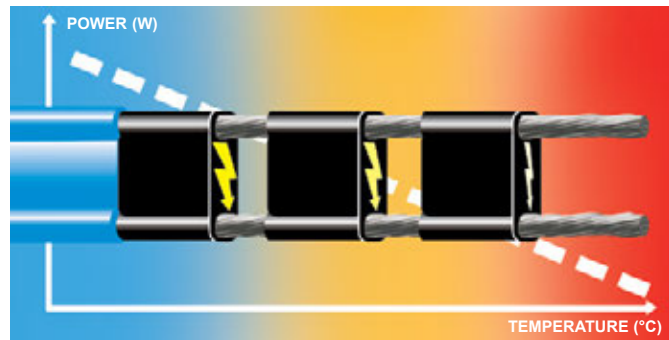

**NB :** unlike the other heating elements, it is impossible to check that a self-regulating cable is operating correctly by measuring resistance with an ohmmeter. This can be done instead by measuring the voltage/current.

## SERIES RESISTORS

A series resistor is an element with an electric current running between its two ends. It dissipates an amount of power governed by Ohm's law (cf. formula). As a result, any change in length, voltage or current is extremely tricky and means that we have to perform a new, in-depth study.

For series resistors sold by their Ohm/m rating (semi-finished products ordered by the metre or kilometre), a prior study is absolutely essential to at least be sure that the final cut length will produce a maximum power level that is in keeping with the recommendations of our technical documentation.

For finished products sold by their wattage (ordered individually), the power supply voltage must be strictly respected and the length never modified

## TECHNICAL FORMULAE

### OHM'S LAW :

The formulae linking the electrical variables of a purely resistive element are as follows:

$$U = R \times I = P/I = \sqrt{P \times R}$$

$$I = U/R = \sqrt{P/R} = P/U$$

$$R = U/I = P/I^2 = U^2/P$$

$$P = U \times I = I^2 \times R = U^2/R$$

Where :  
 U : voltage in Volt (V)  
 I : current in Amps (A)  
 R : resistance in Ohm (Ω)  
 P : power in Watt (W)

### WINDING PITCH:

The winding pitch is the distance between two successive turns of a cable wound round a cylindrical support. This winding should be used when the linear power obtained by straight tracing is insufficient or when very uniform heating is required.

$$P = \frac{\pi \times D \times L}{\sqrt{T^2 - L^2}} \quad T = \sqrt{\frac{(\pi \times D \times L)^2}{P^2} + L^2}$$

All measurement in mm :  
 P : winding pitch in mm  
 D : outside diameter of the support  
 L : Total length of the piping  
 T : Total length of the cable

### USUAL METAL PIPE DIAMETERS

Nominal diameter DN (inches)	1/4	3/8	1/2	3/4	1	1 <sup>1/4</sup>	1 <sup>1/2</sup>	2	2 <sup>1/2</sup>	3	3 <sup>1/2</sup>	4	5	6	8	10	12
Outside diameter D (mm)	13.71	17.14	21.34	26.67	33.4	42.16	48.26	60.32	73.02	88.9	101.6	114.3	141.3	168.27	219.07	273.05	323.85

### LOSSES PER m OF PIPING: HEAT LOSSES TO BE COMPENSATED FOR IN ORDER TO MAINTAIN A TEMPERATURE

$$Q = \frac{\pi \times (T_m - T_a)}{2 \times \lambda} \times L \ln \left( \frac{D + 2 \times e}{D} \right)$$

Where :

Ambient temperature	T <sub>a</sub>	°C
Maintenance temperature	T <sub>m</sub>	°C
Outside dia. of piping	D	mm
Thickness of heat lagging	e	mm
Heat lagging lambda	λ	W/m.K
Theoretical losses	Q	W/m

**IMPORTANT :** this is a theoretical calculation and must be weighted using a safety coefficient which depends on how the installation will be used. Please consult us to evaluate this coefficient.

### LOSSES in W/m FOR INSULATED PIPING

Thermal insulation thickness (mm)	dT in °C	Dimension of the piping																			
		ND (mm)	8	15	20	25	32	40	50	65	80	100	150	200	250	300	350	400	450	500	600
		Out.D (mm)	14	21	27	34	42	48	60	76	89	114	168	219	273	324	356	406	457	508	610
10	20	6.2	7.2	8.5	10	12	14	16	19	23	28.8	41.1	52.6	64.7	76.1	83.3	94.6	106	117	140	
	30	9.4	11	13	15	19	21	25	29	35	43.8	62.5	80	98.5	116	127	144	161	178	213	
	40	13	15	18	21	25	28	34	40	47.3	59.2	84.5	108	133	157	171	195	218	241	287	
20	20	4	4.6	5.3	6.2	7.3	8	9.5	11	13	16	22.5	28.5	34.9	40.9	44.7	50.7	56.7	62.6	74.6	
	30	6.2	7	8.1	9.4	11	12	15	17	19.8	24.4	34.2	43.4	53.2	62.3	68	77.1	86.2	95.3	113	
	40	8.3	9.5	11	13	15	17	20	23	26.7	33	46.3	58.7	71.9	84.2	92	104	117	129	153	
25	20	3.6	4.1	4.6	5.3	6.2	6.9	8.1	9.3	10.9	13.4	18.6	23.5	28.7	33.5	36.5	41.4	46.2	51.1	60.7	
	30	5.4	6.2	7.1	8.1	9.5	10	12	14	16.6	20.3	28.3	35.7	43.6	51	55.6	63	70.3	77.7	92.4	
	40	7.4	8.4	9.5	11	13	14	17	19	22.4	27.5	38.2	48.3	59	69	75.2	85.2	95.1	105	125	
30	20	3.3	3.7	4.2	4.8	5.5	6.1	7.1	8.1	9.5	11.6	15.9	20.1	24.4	28.5	31	35.1	39.2	43.2	51.3	
	30	5	5.6	6.3	7.3	8.4	9.2	11	12	14.4	17.6	24.3	30.5	37.1	43.3	47.2	53.4	59.6	65.8	78.1	
	40	6.7	7.6	8.6	9.8	11	13	15	17	19.5	23.8	32.8	41.3	50.2	58.6	63.8	72.2	80.6	88.9	106	
40	20	2.8	3.2	3.6	4	4.6	5	5.8	6.6	7.6	9.2	12.6	15.7	19	22.1	24	27.1	30.2	33.3	39.4	
	30	4.3	4.8	5.4	6.1	7	7.7	8.9	10	11.6	14.1	19.1	23.9	28.9	33.6	36.6	41.3	45.9	50.6	60	
	40	5.8	6.5	7.3	8.3	9.5	10	12	14	15.7	19	25.9	32.3	39.1	45.5	49.4	55.8	62.1	68.5	81.1	
50	20	2.6	2.8	3.2	3.6	4.1	4.4	5	5.7	6.5	7.8	10.5	13.1	15.7	18.2	19.8	22.3	24.7	27.2	32.2	
	30	3.9	4.3	4.8	5.4	6.2	6.7	7.7	8.7	9.9	11.9	16	19.9	23.9	27.7	30.1	33.9	37.6	41.4	48.9	
	40	5.3	5.9	6.5	7.3	8.4	9.1	10	12	13.4	16.1	21.7	26.9	32.3	37.5	40.7	45.8	50.9	56	66.2	
60	20	2.1	2.3	2.6	2.8	3.2	3.4	3.8	4.3	4.8	5.7	7.4	9	10.7	12.3	13.3	14.9	16.4	18	21.1	
	30	3.2	3.5	3.9	4.3	4.8	5.2	5.8	6.5	7.3	8.6	11.3	13.7	16.3	18.7	20.2	22.6	25	27.4	32.1	
	40	4.4	4.8	5.2	5.8	6.5	7	7.9	8.8	9.9	11.6	15.2	18.5	22	25.3	27.3	30.6	33.8	37	43.5	
80	20	2.1	2.3	2.6	2.8	3.2	3.4	3.8	4.3	4.8	5.7	7.4	9	10.7	12.3	13.3	14.9	16.4	18	21.1	
	30	3.2	3.5	3.9	4.3	4.8	5.2	5.8	6.5	7.3	8.6	11.3	13.7	16.3	18.7	20.2	22.6	25	27.4	32.1	
	40	4.4	4.8	5.2	5.8	6.5	7	7.9	8.8	9.9	11.6	15.2	18.5	22	25.3	27.3	30.6	33.8	37	43.5	
100	20	2.1	2.3	2.6	2.8	3.2	3.4	3.8	4.3	4.8	5.7	7.4	9	10.7	12.3	13.3	14.9	16.4	18	21.1	
	30	3.2	3.5	3.9	4.3	4.8	5.2	5.8	6.5	7.3	8.6	11.3	13.7	16.3	18.7	20.2	22.6	25	27.4	32.1	
	40	4.4	4.8	5.2	5.8	6.5	7	7.9	8.8	9.9	11.6	15.2	18.5	22	25.3	27.3	30.6	33.8	37	43.5	
120	20	2.1	2.3	2.6	2.8	3.2	3.4	3.8	4.3	4.8	5.7	7.4	9	10.7	12.3	13.3	14.9	16.4	18	21.1	
	30	3.2	3.5	3.9	4.3	4.8	5.2	5.8	6.5	7.3	8.6	11.3	13.7	16.3	18.7	20.2	22.6	25	27.4	32.1	
	40	4.4	4.8	5.2	5.8	6.5	7	7.9	8.8	9.9	11.6	15.2	18.5	22	25.3	27.3	30.6	33.8	37	43.5	
140	20	2.1	2.3	2.6	2.8	3.2	3.4	3.8	4.3	4.8	5.7	7.4	9	10.7	12.3	13.3	14.9	16.4	18	21.1	
	30	3.2	3.5	3.9	4.3	4.8	5.2	5.8	6.5	7.3	8.6	11.3	13.7	16.3	18.7	20.2	22.6	25	27.4	32.1	
	40	4.4	4.8	5.2	5.8	6.5	7	7.9	8.8	9.9	11.6	15.2	18.5	22	25.3	27.3	30.6	33.8	37	43.5	
160	20	2.1	2.3	2.6	2.8	3.2	3.4	3.8	4.3	4.8	5.7	7.4	9	10.7	12.3	13.3	14.9	16.4	18	21.1	
	30	3.2	3.5	3.9	4.3	4.8	5.2	5.8	6.5	7.3	8.6	11.3	13.7	16.3	18.7	20.2	22.6	25	27.4	32.1	
	40	4.4	4.8	5.2	5.8	6.5	7	7.9	8.8	9.9	11.6	15.2	18.5	22	25.3	27.3	30.6	33.8	37	43.5	
180	20	2.1	2.3	2.6	2.8	3.2	3.4	3.8	4.3	4.8	5.7	7.4	9	10.7	12.3	13.3	14.9	16.4	18	21.1	
	30	3.2	3.5	3.9	4.3	4.8	5.2	5.8	6.5	7.3	8.6	11.3	13.7	16.3	18.7	20.2	22.6	25	27.4	32.1	
	40	4.4	4.8	5.2	5.8	6.5	7	7.9	8.8	9.9	11.6	15.2	18.5	22	25.3	27.3	30.6	33.8	37	43.5	

### CONVERTING BETWEEN THE METRIC SYSTEM AND THE IMPERIAL SYSTEM

Unit	x	Coefficient	=	Unit
millimetres	x	0.03937	=	inches
millimetres	x	39.37	=	mils
metres	x	39.37	=	inches
metres	x	3.28	=	feet
inches	x	25.4	=	millimetres
feet	x	0.3048	=	metres
mils	x	0.0254	=	millimetres
kilograms	x	2.205	=	pounds
pounds	x	0.4536	=	kilograms

Unit	x	Coefficient	=	Unit
Ω / km	x	0.3048	=	Ω / 1000 feet
Ω / 1000 feet	x	3.281	=	Ω / km
pounds / 1000 feet	x	1.488	=	kilograms/km
square inches	x	645.2	=	square millimetres
square millimetres	x	1.273	=	circular mms
square millimetres	x	1973.5	=	circular mils
square mils	x	1.273	=	circular mils
circular mms	x	1550	=	circular mils
circular mils	x	0.7854	=	square millimetres

### BEHAVIOUR WITH COMMON CHEMICALS

	PTFE Fluoropolymer			PVC			Silicon elastomer		
	A	D	B	A	D	B	A	D	B
<b>A</b> Excellent <b>B</b> Good <b>C</b> Average <b>D</b> Not good Unknown <b>1</b> At 20°C <b>2</b> Up to 50°C <b>3</b> For O-ring									
Acetaldehyde	A	D	A	A	D	A	A	D	A
Acetamide	A	D	B	A	D	B	A	D	B
Acetic acid	A	D	B	A	D	B	A	D	B
	20%	A	D	A	D	B	A	D	B
	80%	A	D	A	D	B	A	D	B
	glacial	A	D	A	D	B	A	D	B
Acetic anhydride	A	D	B	A	D	B	A	D	B
Acetone	A	D	B	A	D	B	A	D	B
Acetylene	A	A1	B	A	A1	B	A	A1	B
Aluminium fluoride	A	A2	B	A	A2	B	A	A2	B
Aluminium hydroxide	A	A2	B	A	A2	B	A	A2	B
Aluminium sulphate	A	A2	B	A	A2	B	A	A2	B
Alums	A	A	A1	A	A	A1	A	A	A1
Ammonia	10%	A	B1	A	B1	A	A	B1	A
Ammonia anhydrous	A	A2	C	A	A2	C	A	A2	C
Ammonia liquid	A	A1	C	A	A1	C	A	A1	C
Ammonium carbonate	A	A2	C	A	A2	C	A	A2	C
Ammonium chloride	A	A2	C	A	A2	C	A	A2	C
Ammonium hydroxide	A	A	A	A	A	A	A	A	A
Ammonium nitrate	A	A2	C	A	A2	C	A	A2	C
Ammonium phosphate									
	Dibasic	A2	A2	A	A2	A2	A	A2	A2
	Monobasic	A	A	A	A	A	A	A	A
	Tribasic	A	A	A	A	A	A	A	A
Ammonium sulphate		A	A2	A	A	A2	A	A	A2
Ammonium thioisulphate		-	-	-	-	-	-	-	-
Amyl alcohol	A	A2	D	A	A2	D	A	A2	D
Amyl chloride	A	D	D	A	D	D	A	D	D
Aniline	A	C1	B	A	C1	B	A	C1	B
Aqua regal									
(80 % HCl + 20 % HNO3)	A	C1	D	A	C1	D	A	C1	D
Arsenic acid	A	A1	A	A	A1	A	A	A1	A
Arsenic salts	-	A	-	-	A	-	-	A	-
Asphalt	A1	A2	D	A1	A2	D	A1	A2	D
ASTM n°1oil	-	-	B	-	-	B	-	-	B
ASTM n°2 oil	-	-	C	-	-	C	-	-	C
ASTM n°3 oil	-	-	C	-	-	C	-	-	C
Barium carbonate	A	A2	-	A	A2	-	A	A2	-
Barium chloride	A	A1	A	A	A1	A	A	A1	A
Barium hydroxide	A	A2	A	A	A2	A	A	A2	A
Barium sulphate	A	B1	A	A	B1	A	A	B1	A
Barium sulfide	A	A2	A	A	A2	A	A	A2	A
Beer	A	A2	A	A	A2	A	A	A2	A
Beet sugar liquids	A1	A2	A	A1	A2	A	A1	A2	A
Benzaldehyde	A1	D	D	A1	D	D	A1	D	D
Benzen	A	C1	D	A	C1	D	A	C1	D
Benzyl chloride	-	-	D	-	-	D	-	-	D
Borax (Sodium borate)	A	A1	B	A	A1	B	A	A1	B
Boric acid	A	A2	A	A	A2	A	A	A2	A
Bromine	A	C1	D	A	C1	D	A	C1	D
Butane	A	C1	D	A	C1	D	A	C1	D
Butyl alcohol	A2	C1	B	A2	C1	B	A2	C1	B
Butyl ether	A1	A2	D	A1	A2	D	A1	A2	D
Butyric acid	A2	B1	D	A2	B1	D	A2	B1	D
Calcium bisulfate	A	B	A	A	B	A	A	B	A
Calcium chloride	A	C	A	A	C	A	A	C	A
Calcium hydroxide	A	B	A	A	B	A	A	B	A
Calcium hypochlorite									
	20%	A	B1	A	B1	A	A	B1	A
Carbolic acid	A	D	D	A	D	D	A	D	D
Carbon dioxide	A	A1	B	A	A1	B	A	A1	B
Carbon monoxide	A	A2	A2	A	A2	A2	A	A2	A2
Carbon oxide	A	A2	A2	A	A2	A2	A	A2	A2
Carbon tetrachloride	A	-	D	A	-	D	A	-	D
Carbon tetrachloride dry	A	-	D	A	-	D	A	-	D
Caustic potash	A	A1	C	A	A1	C	A	A1	C
Caustic soda									
	20%	A	A	A2	A	A	A2	A	A
	50%	A	A	A1	A	A	A1	A	A
	80%	A1	A	A1	A1	A	A1	A	A1
Chloroacetic acid	A	B1	D	A	B1	D	A	B1	D
Chlorine	A	A2	D	A	A2	D	A	A2	D
Chlorine anhydrous liquid	A	D	D	A	D	D	A	D	D
Chlorine dry	A	D	D	A	D	D	A	D	D
Chlorobenzene	B	D	D	B	D	D	B	D	D
Chlorobromomethane	A	D	D	A	D	D	A	D	D
Chloroform	A1	D	D	A1	D	D	A1	D	D
Chlorosulfonic acid	A	D	D	A	D	D	A	D	D
Chromic acid									
	5%	A	A2	C	A	A2	C	A	A2
	10%	A	A2	C	A	A2	C	A	A2
	30%	A	A1	C	A	A1	C	A	A1
	50%	A	D	C	A	D	C	A	D
Citric acid	A	B2	A	A	B2	A	A	B2	A
Coconut oil	A	A1	A	A	A1	A	A	A1	A
Cod liver oil	A	A1	B	A	A1	B	A	A1	B
Copper chloride	A	A1	A1	A	A1	A1	A	A1	A1
Copper cyanide	A	A2	A	A	A2	A	A	A2	A
Copper nitrate	A	A2	-	A	A2	-	A	A2	-
Copper sulphate									
	5%	A	A2	A	A	A2	A	A	A
	> 5%	A	A2	A	A	A2	A	A	A
Com oil	A	B	A	A	B	A	A	B	A
Cottonseed oil	A	B2	A	A	B2	A	A	B2	A
Cresylic acid	A	D	D	A	D	D	A	D	D
Cyclohexane	A	D	D	A	D	D	A	D	D
Cyclohexanone	A	D	D	A	D	D	A	D	D
Diacetone alcohol	A	B1	D	A	B1	D	A	B1	D
Dichlorobenzene	A	D	D	A	D	D	A	D	D
Diethylamine	D	D	B	D	D	B	D	D	B
Diethyleneglycol	A2	C1	B1	A2	C1	B1	A2	C1	B1
Dimethylaniline	A	D	D	A	D	D	A	D	D
Dimethylformamide	D	D	C	D	D	C	D	D	C
Diphenyloxide	A1	D	C	A1	D	C	A1	D	C
Distilled water	A	A2	C	A	A2	C	A	A2	C
Ethane	A	A1	D	A	A1	D	A	A1	D
Ethanol	A	C	B	A	C	B	A	C	B
Ethanolamine	A1	D	B	A1	D	B	A1	D	B
Ether	A	D	D	A	D	D	A	D	D
Ethyl alcohol	A	C	B	A	C	B	A	C	B
Ethyl bromide	A	D	D	A	D	D	A	D	D
Ethyl chloride	A	D	D	A	D	D	A	D	D
Ethylene chlorhydrine	A	D	C	A	D	C	A	D	C
Ethylene diamine	A	D	A	A	D	A	A	D	A
Ethylene dichloride	A	D	D	A	D	D	A	D	D
Ethylene glycol	A	A	A	A	A	A	A	A	A
Ethylene oxide	A	D	D	A	D	D	A	D	D
Fatty acids	A	A	C	A	A	C	A	A	C
Ferric chloride	A	A	B	A	A	B	A	A	B
Ferric sulphate	A	A	B	A	A	B	A	A	B
Ferrous chloride	A	A	-	A	A	-	A	A	-
Ferrous sulphate	A	A	-	A	A	-	A	A	-
Formaldehyde									
	40%	A	A	-	A	A	-	A	A
	100%	A	A	B	A	A	B	A	A
Formic acid	A	A1	B	A	A1	B	A	A1	B
Freon 11	A	A2	D	A	A2	D	A	A2	D
Freon 12	A	A2	D	A	A2	D	A	A2	D
Freon 22	A	A	D	A	A	D	A	A	D
Freon 113	A	B	D	A	B	D	A	B	D
Freon TF	-	B	D	-	B	D	-	B	D
Fuel oil	B	A2	D	B	A2	D	B	A2	D
Furane (resin)	A	A	D	A	A	D	A	A	D
Furfural	A	D	D	A	D	D	A	D	D
Gasoline	B	A	D	B	A	D	B	A	D
Gelatine	A	B	A	A	B	A	A	B	A
Glucose	A	A2	A	A	A2	A	A	A2	A
Glycerine	A	A	A	A	A	A	A	A	A
Grease	A	A	D	A	A	D	A	A	D
Hexane	A	B1	D	A	B1	D	A	B1	D
Hexyl alcohol	A	A2	B	A	A2	B	A	A2	B
Hydraulic oil	A	A	B	A	A	B	A	A	B
Hydrobromic acid									
	20%	-	B2	D	-	B2	D	-	B2
	100%	A	A1	D	A	A1	D	A	A1
Hydrochloric acid									
	20%	A	A2	D	A	A2	D	A	A2
	37%	A	B	B	A	B	B	A	B
	100%	A	D	D	A	D	D	A	D
Hydrocyanic acid	A	B	C	A	B	C	A	B	C
Hydrofluoric acid									
	20%	A	B	D	A	B	D	A	B
	50%	A	B1	D	A	B1	D	A	B1
	75%	A	C	D	A	C	D	A	C
	100%	A	C	D	A	C	D	A	C
Hydrogen	A	A2	C	A	A2	C	A	A2	C
Hydrogen (dry)	A	A2	C	A	A2	C	A	A2	C
Hydrogen gas	A	A2	C	A	A2	C	A	A2	C
Hydrogen peroxide									
	10%	A	A1	A	A	A1	A	A	A1
	30%	A	A1	B	A	A1	B	A	A1
	50%	A	A1	B	A	A1	B	A	A1
	100%	A	A	B	A	A	B	A	A
Hydrogen sulphide	A	B1	C	A	B1	C	A	B1	C
Isobutyl alcohol	A2	A1	A	A2	A1	A	A2	A1	A
Isooctane	A	A1	D	A	A1	D	A	A1	D
Isopropyl ether	A1	B	D	A1	B	D	A1	B	D

## LEGAL UNITS IN THE INTERNATIONAL MEASUREMENT SYSTEM (SI)

	Variables		Unit	Customary units	
	Names	Symbols	Names and symbols	Names and symbols	SI value
GEOMETRY	Length		metre (m)		
	Wavelength	$\lambda$	metre (m)		
	Wavenumber	$\sigma$	metre to the power minus one (m <sup>-1</sup> )		
	Surface area	A	square metre (m <sup>2</sup> )	are (a) hectare (ha)	10 <sup>2</sup> 10 <sup>4</sup>
	Cross section	$\sigma$	square metre (m <sup>2</sup> )	barn (b)	10 <sup>-28</sup>
	Volume	V	cubic meter (m <sup>3</sup> )	litre (L or l)	10 <sup>-3</sup>
	Plane angle	$\alpha$	radian (rad)		
MASS	Solid angle	sr	steradian (sr)		
	Mass	m	kilogram (kg)	tonne (t)	10 <sup>3</sup>
	Atomic mass	$m_a$	kilogram (kg)		
	Mass per unit length	$\rho_l$	kilograms par metre (kg/m)	tex (tex)	10 <sup>6</sup>
	Surface density	$\rho_s$	kilogramme par mètre carré (kg/m <sup>2</sup> )		
	Density	$\rho$	kilograms par cubic metre (kg/m <sup>3</sup> )		
	Volume per unit mass	v	cubic metre per kilogram (m <sup>3</sup> /kg)		
TIME	Concentration	$\rho_B$	kilograms per cubic metre (kg/m <sup>3</sup> )		
	Time	t	second (s)		
	Frequency	f	hertz (Hz)		
	Velocity	v	metre per second (m/s)		
	Angular velocity	$\omega$	radian per second (rad/s)		
	Acceleration	a	metre per second squared (m/s <sup>2</sup> )	gal (Gal)	10 <sup>-2</sup>
	Angular acceleration	$\alpha$	radian per second squared (rad/s <sup>2</sup> )		
MECHANICS	Force	F	newton (N)		
	Moment of force	M	newton-metre (N.m)		
	Surface voltage	$\gamma$	newtons per metre (N/m)		
	Work, energy, quantity of heat	W	joule (J)		
	Radiant intensity	I	watts per steradian (W/sr)		
	Power, radiant flux thermal flux	$\frac{P}{\phi}$	watt (W)		
	Strain	$\sigma$	pascal (Pa)	bar (bar)	10 <sup>5</sup>
	Pressure	$\rho$			
	Dynamic viscosity	$\eta$	pascal-second (p.s) ou poiseuille	poise (P)	10 <sup>-1</sup>
	Kinetic viscosity	v	square metre per second (m <sup>2</sup> /s)	stockes (St)	10 <sup>-4</sup>

	Variables		Unit	Customary units		
	Names	Symbols	Names and symbols	Names and symbols	SI	
ELECTRICITY	Electric current	I	ampere (A)	biot (bi)	10	
	Electromotive force	E	volt (V)			
	Potential difference, voltage	U				
	Electrical resistance	R	ohm ( $\Omega$ )			
	Electric field strength	E	volt per metre (V/m)			
	Electrical conductance	G	siemens (S)	mho	1	
	Amount of electricity, electrical charge	Q	coulomb (C)			
	Electrical capacity	C	farad (F)			
	Self-induction	L	henry (H)			
	Magnetic flux induction	$\phi$	weber (Wb)	maxwell (Mx, M)	10 <sup>4</sup>	
HEAT	Magnetic induction	B	tesla (T)	Gamma ( $\gamma$ ) Gauss (Gs, G)	10 <sup>-9</sup> 10 <sup>4</sup>	
	Magnetic field strength	H	ampere per metre (A/m)			
	Magnetomotive force	F	ampere (A)			
	Temperature	T	kelvin(K) degree Celsius (°C)			
	Heat capacity	C				
	entropy	S	joule per kelvin (J/K)			
	Specific heat capacity, specific entropy	c	joule per kilogram kelvin (J/(kg.K))			
	Thermal conductivity	$\lambda$	watt per metre-kelvin (W/(m.K))			
	IONISING CHEMISTRY RADIATION	Activity	A	becquerel (Bq)		
		Exposure	X	coulomb per kilogram (C/kg)		
Absorbed dose		D	gray (Gy)	rad(rd)	10 <sup>-2</sup>	
Dose equivalent		H	sievert (Sv)	rem (rem)	10 <sup>-2</sup>	
PHYSICAL CHEMISTRY RADIATION	Quantity of matter	n	mole (mol)			
	OPTICS	Light intensity	I	candela (cd)		
		Luminous flux	$\phi$	lumen (lm)		
		Illuminance	E	lux (lx)		
Luminance		L	candela per square metre (cd/m <sup>2</sup> )			
Optical system vergence			metre to the power minus one (m <sup>-1</sup> )			

## MAIN CONVERSION FACTORS

Unit	Conversion factor	Unit	Conversion factor
<b>Length (conversion into metres)</b>			
ångström (Å)	1 x 10 <sup>-10</sup>	mile	1.609344 x 10 <sup>3</sup>
light year	9.46073 x 10 <sup>15</sup>	mile (nautical mile)	1.852 x 10 <sup>3</sup>
fermi (fm)	1 x 10 <sup>-15</sup>	pica	4.2175 x 10 <sup>3</sup>
foot (ft)	3.048 x 10 <sup>-1</sup>	point (US)	3.515 x 10 <sup>3</sup>
inch (in)	2.54 x 10 <sup>-2</sup>	rod	5.029 2
micron ( $\mu$ )	1 x 10 <sup>-6</sup>	sigma ( $\sigma$ )	1 x 10 <sup>-12</sup>
mil	2.54 x 10 <sup>-5</sup>	yard (yd)	9.144 x 10 <sup>-1</sup>
<b>Area (conversions into square metres)</b>			
are (a)	1 x 10 <sup>2</sup>	rood	1.01171 x 10 <sup>3</sup>
circular mil	5.067075 x 10 <sup>-10</sup>	acre	4.04686 x 10 <sup>3</sup>
<b>Volume (conversion into cubic metres)</b>			
barrel (US)	1.58987 x 10 <sup>-1</sup>	gill (UK)	1.42065 x 10 <sup>-4</sup>
board foot	2.36 x 10 <sup>-3</sup>	gill [US](gi)	1.18294 x 10 <sup>-4</sup>
bushel (UK)	3.63687 x 10 <sup>-2</sup>	liquid pint [US](liq pt)	4.73176 x 10 <sup>-4</sup>
bushel [US](bu)	3.52391 x 10 <sup>-2</sup>	liquid quart [US](liq qt)	9.46352 x 10 <sup>-4</sup>
dry barrel [US](bbl)	1.15627 x 10 <sup>-1</sup>	litre (L, l)	1 x 10 <sup>-3</sup>
dry pint [US](dry pt)	5.50610 x 10 <sup>-4</sup>	minim [UK](min)	5.91939 x 10 <sup>-8</sup>
dry quart [US](dry qt)	1.10122 x 10 <sup>-3</sup>	minim [US](min)	6.16115 x 10 <sup>-8</sup>
fluid ounce [UK](fl oz)	2.84130 x 10 <sup>-5</sup>	peck (UK)	9.0922 x 10 <sup>-3</sup>
fluid ounce [US](fl oz)	2.95735 x 10 <sup>-5</sup>	peck (US)	8.809768 x 10 <sup>-3</sup>
gallon [UK](gal)	4.54609 x 10 <sup>-3</sup>	quart [UK](qt)	1.13652 x 10 <sup>-3</sup>
gallon [US](gal)	3.78541 x 10 <sup>-3</sup>		
<b>Plane angle (conversion into radians)</b>			
degree (°)	1.745329 x 10 <sup>-2</sup>	minute (')	2.908882 x 10 <sup>-4</sup>
grade (gr)	1.570796 x 10 <sup>-2</sup>	second (")	4.848137 x 10 <sup>-6</sup>
<b>Time (conversion into seconds)</b>			
hour (h)	3.6 x 10 <sup>3</sup>	minute (min)	60
day (d, j)	8.64 x 10 <sup>4</sup>		
<b>Mass (conversion into kilograms)</b>			
cental	4.53592 x 10	ton (ton)	1.016047 x 10 <sup>3</sup>
long ton (US)	1.016047 x 10 <sup>3</sup>	tonne (t)	1 x 10 <sup>3</sup>
ounce (oz)	2.834952 x 10 <sup>-2</sup>	troy ounce	3.11035 x 10 <sup>-2</sup>
pound (lb)	4.535924 x 10 <sup>-1</sup>	troy pound	3.73242 x 10 <sup>-1</sup>
quintal (q)	1 x 10 <sup>2</sup>	unité de masse atomique (u)	9.07185 x 10 <sup>-31</sup>
short ton (sh tn)	1.66054 x 10 <sup>3</sup>		
<b>Velocity (conversion into metres per second)</b>			
International knot, knot	5.144 44 x 10 <sup>-1</sup>		

Unit	Conversion factor	Unit	Conversion factor
<b>Force (conversion into newtons)</b>			
dyne (dyn)	1 x 10 <sup>-5</sup>	pound-force (lbf)	4.44822
kilogram-force (kgf)	9.80665	poundal (pdl)	1.38255 x 10 <sup>-1</sup>
pound (p)	9.80665 x 10 <sup>-3</sup>		
<b>Work, energy (conversion into joules)</b>			
british thermal unit (Btu) (Intern Table)	1.055056 x 10 <sup>3</sup>	kilogrammetre (kgm)	9.80665
calorie I.T. (cal I.T)	4.186 8	therm	1.055056 x 10 <sup>8</sup>
calorie 15°C (cal15)	4.185 5	thermie (th)	4.1855 x 10 <sup>6</sup>
electronvolt (eV)	1.60218 x 10 <sup>-19</sup>	thermochemical calorie (calth)	4.184
frigorie (fg)	- 4.1855 x 10 <sup>3</sup>	watthour (Wh)	3.6 x 10 <sup>3</sup>
<b>Power (conversion into watts)</b>			
metric horse power	7.354 99 x 10 <sup>2</sup>	var (var)	
mechanical horse power [UK]	7.457 0 x 10 <sup>2</sup>		
<b>Strain and pressure (conversion into pascals)</b>			
normal atmosphere (atm)	1.013 25 x 10 <sup>5</sup>	inch of mercury (inHg)	3.386 39 x 10 <sup>3</sup>
technical atmosphere (at)	9.806 65 x 10 <sup>4</sup>	millimetre of water (mmH2O)	9.806 65
bar (bar)	1 x 10 <sup>5</sup>	millimetre of mercury (mmHg)	1.333224 x 10 <sup>2</sup>
foot of water (ftH2O)	2.989 07 x 10 <sup>3</sup>	pound-force per square inch (psi)	6.894 757 x 10 <sup>3</sup>
inch of water (inH2O)	2.490 89 x 10 <sup>2</sup>	torr (Torr)	1.333 224 x 10 <sup>2</sup>
<b>Magnetomotive force (conversion into amperes)</b>			
gilbert (Gb)	7.957 7 x 10 <sup>-1</sup>		
<b>Quantity of electricity, electrical charge (conversion into coulombs)</b>			
ampere-hour (Ah)	3.6 x 10 <sup>3</sup>	franklin (Fr)	3.335 64 x 10 <sup>-10</sup>
farafay (F)	9.648 70 x 10 <sup>4</sup>		
<b>Activity (conversion into becquerels)</b>			
curie (Ci)	3.7 x 10 <sup>10</sup>		
<b>Exposure (conversion into coulombs per kilogram)</b>			
röntgen (R)	2.58 x 10 <sup>-4</sup>		

## LIQUIDS HEATING (NOTES AND FORMULAE)

### PHYSICAL CHARACTERISTICS OF THE MAIN LIQUIDS

LIQUIDS	DENSITY kg/dm <sup>3</sup>	Solidific. TEMP. °C	Boiling TEMP. °C	Cp K.Cal/kg°C	Heat of vaporis. K.Cal/kg
Acetone	0,814	- 95	57	0,53	124,5
Acetic acid	1,07	17	118	0,51	117
Hydrochloric acid	1,2	-114	83	0,60	97,5
Formic acid	1,23	8,4	100,7	0,39	120
Nitric acid	1,52	-42	86	0,66	115
Sulfuric acid at 66° B	1,80	10	330	0,33	123
Ethyl alcohol	0,80	-130	78	0,68	210
Methyl alcohol	0,80	-97,8	65	0,60	269
Ammonia	0,82	-78	-33,4	1,1	327
Benzene	0,87	5	80	0,45	-94
Beer	1	2		1	
Bromine	3	-7	58,8	0,11	43,7
Chloroform	1,48	-63	61	0,23	60
Methyl chloride	1,33	-96	40	0,60	95
Water	1	0	100	1	539
Turpentine	0,86			0,42	
Ether	0,74	-117	35	0,54	90
Freon 12	1,33		-30	0,20	40
Glycerine	1,27	17	290	0,58	
Mineral oil	0,84			0,50	
Paraffin oil	0,88			0,52	
Castor oil	0,96			0,43	68
Milk	1,03			0,94	
Methacrylate	0,9			0,25	
Mercury	13,6	-39	358	0,033	73
Paraffin	0,8			0,45	
Tetrachlorethylene	1,6	-20	120	0,22	52
Petroleum	0,89			0,50	
Phenol	1,08	41	182	0,56	
Carbon disulphide	1,27	-108	46	0,23	90
Carbon tetrachloride	1,63	-23	76,8	0,21	45
Toluene	0,87	-95	110,6	0,39	
Trichlorethylene	1,49	-73	87	0,23	57,3
Wine	0,99			0,90	
Vinegar	1,02			0,92	
Honey	1,395 to 1,445			0,6 to 0,65 (liquid) 0,65 to 0,70 (solid)	

#### Notes:

Aqueous solutions have a specific heat that varies between that of water for very weak concentrations and the specific heat of the substance for strong concentrations.

All oils have a specific heat of approximately 0.5.

Boiling temperature and solidification temperature vary with pressure. Heat of vaporisation varies with temperature.

For water, Régnault's formula is applied:

$L = 606,5 - 0,695 T$ , which gives for  $T = 100^\circ$ : 537 Kcal/kg.

## THERMAL CONDUCTIVITY AND SPECIFIC HEAT

### Metals, liquids, air

	TEMP. °C	Thermal conductivity coefficient $\lambda$		Average specific heat	
		Kcal.h m°C	W m°C	Kcal./Kg °C	J/Kg°C
<b>Metals</b>					
Pure aluminium	20°	197	228	0,22	921
Steel ( $c = 1,5$ )	20°	45	52	0,115	481
Pure copper	20°	332	385	0,094	393
Brass	20°	63	73	0,092	385
Zinc					
<b>Various material</b>					
Asbestos	20°	0,13	0,15	0,20	837
Asphalt	20°	0,80	0,93	0,22	921
Concrete (2000 Kg/m <sup>3</sup> )	20°	0,80	0,93	0,22	921
Bitumen	20°	0,14	0,16	0,15	628
Solid bricks	20°	0,42	0,49	0,215	900
		à 0,60	à 0,70		
Cement mortar	20°	0,44	0,51	0,22	921
Plaster rendering (1200 Kg/m <sup>3</sup> )	20°	0,37	0,43	0,273	1143
<b>Liquids</b>					
Alcohol	20°	0,15	0,17	0,56	2344
		at 0,20	at 0,23		
Benzol	20°	0,12	0,14	0,42	1758
Heavy fuel	20°	0,116	0,135	0,48	2010
Petroleum	20°	0,13	0,15	0,50	2093
Water	0°	0,477	0,553	1,005	4207
	20°	0,505	0,586	0,999	4182
	60°	0,562	0,652	0,998	4177
<b>Light fuel oil</b>					
(domestic) d = 0,846	20°			0,48	
<b>Steam</b>					
Saturated water at constant pressure	100 to 270°	-	-	0,4639	1942
	100 to 440°	-	-	0,4713	1973
	110 to 620°	-	-	0,4717	1975
<b>Superheated steam</b>					
	150°	-	-	0,16	1925
1 bar	250°	-	-	0,468	1959
1 bar	350°	-	-	0,477	1997
1 bar	450°	-	-	0,486	2034
1 bar	550°	-	-	0,495	2072
4 bars	150°	-	-	0,524	2193
4 bars	350°	-	-	0,490	2051
4 bars	550°	-	-	0,518	2168
<b>Air</b>					
Air à	20°	0,0216	0,025	0,240	1005
	50°	0,0232	0,027	0,241	1008
	100°	0,0259	0,030	0,242	1013
	200°	0,0314	0,036	0,244	1021
	250°	0,0336	0,039	0,245	1026
Polyol d = 1,1				0,525	2200
Isocyanate d = 1,1				0,332	1390

## SPECIFIC WEIGHTS AND DENSITIES OF GASES

in g/dm<sup>3</sup>, AS COMPARED WITH AIR AT 0°C and 760 mm Hg

GAZ	Specific weight	Density	GAZ	Specific weight	Density	GAZ	Specific weight	Density
Acetylene	1,173	0,906	Chlorine	3,219	2,49	Krypton	3,6431	2,818
Hydrobromic acid	3,5035	2,71	Ethyl chloride	2,87	2,219	Methane	0,7168	0,554
Hydrochloric acid	1,6393	1,268	Methyl chloride	0,991	0,766	Neon	0,8713	0,674
Hydrofluoric acid	0,922	0,713	Nitrosyl chloride	2,9863	2,31	Carbonyl chloride	4,47	3,46
Hydriodic acid	5,688	4,4	Cyanogen	2,3348	1,806	Nitrous oxide	1,9781	1,53
Hydroselenic acid	3,67	2,84	Dimethylamine	0,6804	0,526	Nitric oxide	1,340	1,036
Hydrogen sulphide	1,5378	1,1895	Ethane	1,3566	1,057	Carbon monoxide	1,2514	0,968
Air*	1,2928	1	Ethylene	1,264	0,975	Oxygen	1,4289	1,1053
Allylene	1,786	1,381	Fluorine	1,635	1,264	Carbon oxygen sulphide	2,171	2,10
Ammoniac	0,7718	0,597	Silicon tetrafluoride	4,684	3,62	Ozone	2,1434	1,658
Carbon dioxide*	1,9779	1,53	Producer gas	1,141	0,893	Chlorine dioxide	3,01	2,33
Sulphur dioxide	2,9269	2,264	Natural gas (processed)	0,74	0,57	Phosgene	4,5313	3,505
Argon	1,7828	1,38	Helium	0,1768	0,1368	Propane	1,966	1,52
Nitrogen	1,2515	0,968	Hydrogen	0,08982	0,06948	Nitrogen protoxide	1,9779	1,53
Nitrogen dioxide	1,3402	1,0367	Arsine	3,484	2,695	Carbon disulphide	3,4	2,63
Bromine	7,5887	5,87	Hydrogen phosphide	1,529	1,18	Xenon	5,8564	4,53
n-Butane	2,5985	2,01	Hydride-silicon	1,44	1,11			

**1. APPLICATION OF THE GENERAL CONDITIONS OF SALE - CONTESTABILITY**

In accordance with the provisions of the Law of 2 August 2005, these FLEXELEC Conditions of Sale are integral together with the current price list and relevant regulations or recommendations, as circulated periodically and available to every customer in conjunction with its order requirements. These General Conditions of Sale shall be forwarded or presented to each purchaser to enable that party to place an order.

Consequently, the act of placing an order implies the purchaser's full, unreserved adherence to these General Conditions of Sale to the exclusion of all other documents such as brochures and catalogues issued by the vendor, which are only of an indicative nature.

Unless formally accepted in writing by the vendor, no special condition may prevail over the General Conditions of Sale. In the absence of express acceptance, no contrary condition may be raised in objection by the purchaser, regardless of the time when it may have been brought to its knowledge.

Should the vendor not avail itself of any one of these General Conditions of Sale at a given time, this may not be interpreted as constituting renunciation of availing itself of any of the aforementioned conditions whatsoever at a later date.

**2. ORDERS**

Orders are final only when they have been confirmed in writing by the vendor in the form of an acknowledgement of receipt, unless otherwise stipulated.

The vendor is only bound by orders taken by its representatives or employees subject to signed, written confirmation. Benefit from the order is personal to the purchaser and may not be transferred without the vendor's agreement.

**3. CHANGING AN ORDER**

Any change or cancellation of an order requested by the purchaser may be taken into consideration only if it is received in writing prior to shipment of the products.

At the vendor's discretion, amendments or cancellations shall give rise to additional invoicing or the payment of penalties equal to 25 % of the amount of the initial order.

If the vendor does not accept the change or cancellation, any advance payments made will not be returned.

**4. DELIVERY - GOODS DELIVERED**

The vendor reserves the right to make any modifications that he deems appropriate for his goods at any time, and reserves the right to modify the models defined in his brochures or catalogues without providing prior notice and without any obligation to modify products either delivered previously or for which an order is pending.

**5. DELIVERY**

**5.1. TERMS**

Delivery is carried out either by directly delivering the product to the purchaser, or by delivering it to a forwarding agent or carrier at the vendor's warehouses.

The purchaser undertakes to take delivery within 8 days of notice of the goods' availability being provided. Once this period has elapsed, the vendor may either consider the order to be cancelled and the sale to be unilaterally terminated by the purchaser, or storage costs will be taken into account.

**5.2. DELIVERY TIMES**

Deliveries are made only depending on availability and following the sequence in which orders arrive. The vendor is allowed to make either full or partial deliveries.

The delivery times are indicated as precisely as possible, but depend on what options the vendor has in terms of procurement and transport.

Should deliveries take longer than the delivery time stated, this shall not give rise to damages, deductions or the cancellation of orders in progress. Nevertheless if, one month after the indicative delivery date, the goods have not been delivered for any reason other than force majeure, the sale may then be cancelled at the request of either party; the purchaser shall have his advance payment returned, but shall not be eligible for any other compensation or damages.

The following are considered to be cases of force majeure which release the vendor from his obligation to deliver: war, riots, fires, strikes, accidents, or it being impossible for the vendor to obtain procure supplies.

The vendor shall, within an appropriate time, keep the purchaser abreast of the cases and events listed above.

In any case, delivery within the delivery times may be made only out if the purchaser has fulfilled his obligations towards the vendor, for whatever reason.

**5.3. COSTS**

For all deliveries in metropolitan France, the goods are deliverable carriage-paid for any shipment over the value of 750 € before tax.

For shipments under the value of 750 € H.T., before tax, the goods shall be delivered carriage paid in advance. International sales shall be subject to the Incoterm selected and specified by the parties. Should no Incoterm have been selected, the sales are deemed to be EX WORKS.

**5.4. RISKS**

Goods travel at the recipient's risk, that party being responsible for making any observations required in the event of damage or short shipment as well as for confirming reservations stated via a deed prepared out of court or via a registered letter with acknowledgement of receipt from the carrier within three days of receipt of the merchandise.

**6. RECEPTION**

Without prejudice to the provisions to be made in relation to the carrier, complaints regarding conspicuous defects, or non-compliance of the goods delivered with the goods ordered or the dispatch note, must be made in writing within 48 hours of the arrival of the goods.

It will be the purchaser's responsibility to provide any supporting documentation regarding the real nature of the defects or anomalies noted. That party shall grant the vendor every leeway

for the purpose of assessing these defects and setting them right, and shall refrain from intervening himself, or from asking any third party to intervene for this purpose. For goods sold in packaging, the weights and measurements upon departure shall be valid for ascertaining the quantities delivered.

The lengths invoiced shall be the ones actually delivered. When they are subject to special manufacturing, they may differ from the quantities ordered by 10% without this providing grounds for being contested by the purchaser.

**7. REPLACEMENT**

**7.1. TERMS**

Non-compliant or spoiled goods can be replaced.

Returns shall be subject to formal prior agreement between the vendor and the purchaser.

Any goods returned without this agreement would be held for the purchaser and would not lead to a credit being drawn up. The costs and risks involved in such a return shall always be borne by the purchaser.

Merchandise that is returned shall be accompanied by a return slip attached to the package and such merchandise must be in the condition it was in when delivered.

**7.2. CONSEQUENCES**

In the event of a conspicuous defect or non-compliance of the goods delivered, duly noted by the vendor under the conditions set out hereinabove, the purchaser may obtain a free replacement, or a refund for the goods at the vendor's discretion, to the exclusion of any compensation or damages.

**8. WARRANTY FOR CONCEALED DEFECTS**

**8.1. SCOPE**

Goods are guaranteed against concealed defects in pursuance of Article 1641 and subsequent articles in the Civil Code for a period of one month counting from the delivery date.

The vendor's warrantee is limited to defects that are inherent to the goods sold and which existed on the day on which they were sold. The vendor's liability cannot be invoked in the event of abnormal use of the goods or failure to follow safety rules, and notably responsibility transfers to the end user in the case of orders where installation and end use do not follow the FLEXELEC recommendations for installation and use. Under this warranty, the only obligation incumbent on the vendor shall be free replacement or repair (vendor's choice) of a product or component recognised as being defective by his departments. To benefit from the warranty, all products must be submitted to the vendor's after-sales service beforehand, which must provide its approval for any replacement to be provided. Any carriage costs shall be borne by the purchaser.

**8.2. EXCLUSIONS**

The warranty shall not apply to conspicuous defects.

Faults and deterioration due to normal wear and tear or an external accident (incorrect assembly or installation, poor storage conditions, abnormal use, etc.), or due to a modification of the goods which was neither foreseen or specified by the vendor shall also be excluded.

**9. PRICES**

With the exception of orders with particular specifications where the prices are determined by quotation, FLEXELEC products are subject to the list price currently in force as confirmed by simple notification. Prices are net, before tax. Unless otherwise agreed, any request for the provision of additional services such as studies, engineering, test reports, factory acceptance, approval procedures or miscellaneous certificates shall be subject to additional invoicing by the vendor which is separate from the cost of the products sold. The payment currency shall be the Euro unless otherwise stipulated.

Any tax, duty or other provision of service to be paid for in pursuance of French regulations or the regulations of an importing country or a transit country shall be borne by the purchaser.

Unless the vendor provides written agreement, carriage costs shall always be borne by the purchaser.

**10. INVOICING**

An invoice shall be drawn up for each delivery and issued when it is made, unless a summary invoice which refers to several delivery slips that have been issued is drawn up.

**11. PAYMENT**

**11.1. TERMS**

Unless otherwise agreed, payments shall be made within 30 days of the invoice date.

In the event of deferred payment, for the purposes of this article, a payment does not constitute the mere presentation of a commercial paper or cheque implying an obligation to pay, but settlement thereof by the agreed deadline.

**11.2. ADVANCE PAYMENT**

The vendor reserves the option of making the order subject to an advance payment.

**11.3. LATE PAYMENT OR NON-PAYMENT**

In the event of late payment, the vendor may suspend all orders in progress without prejudice to any other course of action.

Any sum not paid by the due date featured on the invoice shall lead to the application of penalties to a sum equal to one and a half times the legal interest rate.

These penalties shall be payable when the vendor so requests.

In the event of non-payment, if forty-eight hours elapse after notice has been provided without any result, the sale shall automatically be cancelled should the vendor deem fit to do so. The vendor may institute summary proceedings to request the return of the goods, without prejudice to any other damages. Cancellation shall apply not only to the assimilable to order in question but also to any prior orders that are unpaid, whether or not deliveries have been made or are being delivered, and whether or not payment for them is due.

In the event of payment using a commercial paper, failure

to return the paper shall be considered to constitute refusal of acceptance comparable to failure to pay. Likewise, when payment is staggered, non-payment of a single instalment shall lead to all of the debt becoming immediately payable without need to provide notice of this.

In all the above cases, the sums that may be due for other deliveries, or for any other reason, shall become payable immediately if the vendor does not opt to cancel the relevant orders.

The purchaser shall provide compensation for all expenses incurred due to the disputed recovery of sums owed, including the professional fees for legal officials.

Under no circumstances may payments be suspended or be subject to any compensation whatsoever without the vendor's prior agreement in writing. Any partial payment shall be attributed firstly to the non-preferential part of the debt, and then to the sums that have been outstanding for the longest.

**11.4. REQUIREMENT OF GUARANTEES OR PAYMENT**

The vendor reserves the option of requiring guarantees, a cash payment, or payment via a bill payable on sight before executing the orders received, notably for international sales.

**12. TRANSFER OF RISKS**

The transfer of risks for products, even for a sale that is agreed to on a carriage-paid basis, shall occur as of shipment from the vendor's warehouse.

In particular, this means that merchandise shall travel at the purchaser's risk, with that party being responsible for stating any reservations or instituting any proceedings against the carriers responsible in the event of damage, losses or short shipment.

**13. RETENTION OF OWNERSHIP**

The goods covered by this contract are sold subject to retention of ownership: transfer of ownership is conditional on the purchaser providing full payment of the price by the agreed deadline.

In the event of failure to pay by the deadline, the vendor shall take the merchandise of which he remains the owner back into his possession and may, at his discretion, choose to terminate the contract via a registered letter sent to the purchaser.

The purchaser shall refrain from any conversion, incorporation or assembly of the merchandise before paying for it.

The purchaser must retain the merchandise sold subject to retention of ownership in such a manner that it cannot get mixed up with merchandise of the same nature from other vendors.

**14. PACKAGING**

Unless otherwise agreed, consignment of the cable drums is invoiced for at the same time as the cables (based on the professional rate in force). A refund is provided for this subject to deduction of a fixed fee if the cable drums are returned carriage-paid and in good condition within a maximum period of 3 months. Beyond this period, the vendor may apply a rental fee of 2.5 % of the price per month.

Packaging and cable drums bearing the vendor's trademark may only be used for his products and may not be used for anyone else's products under any circumstances. Any breach of this rule shall render the party responsible subject to prosecution and the payment of damages.

**15. INDUSTRIAL PROPERTY**

All equipment, models, plans, specifications, technical documents, assembly instructions, user manuals and other items of information provided by the vendor shall remain his property at all times.

The purchaser may not claim any ownership whatsoever over the equipment, models, plans and specifications and other items of information and may not use them outside the context of the sales contract under any circumstances.

The purchaser shall refrain from reproducing the Vendor's products.

All the industrial property rights relating to results stemming from the execution of the order shall remain the vendor's property without any time limits or geographical limits.

**16. CONFIDENTIALITY**

The Purchaser shall consider any information given, technical formula, or concept it may obtain knowledge of through this contract to be strictly confidential and shall refrain from divulging it.

For the purposes of applying this clause, the purchaser shall be responsible both for himself and his employees. However the purchaser shall not be held responsible for any disclosure if the items divulged were in the public domain or if he had knowledge or them or obtained them from a third party by legitimate means. Likewise, the vendor undertakes to keep any information he may have had available in the course of executing this contract strictly confidential and not to divulge it to anyone whatsoever, either during execution of the agreement or following its completion.

**17. COMPETENCE - APPLICABLE LAW**

In the event of litigation of any sort or a dispute regarding the formation or execution of the order, the courts at Thiers - France alone shall be competent, unless the vendor prefers to submit his case to any other competent jurisdiction.

This clause applies even in the case of summary proceedings, incidental claims, or in the event of there being several defenders or the introduction of third parties, regardless of the method and terms of payment, no clauses assigning jurisdiction which may exist in purchasers' documents being able stand in the way of the application of this clause.

The applicable law is French law.

# www.flexelec.com



## FLEXIBLE HEATING CABLES AND ELEMENTS TEMPERATURE MAINTENANCE SYSTEMS



headquarters and main factory

### **FLEXELEC S.A.S**

10, rue des frères Lumière - Z.A. du Bois Rond  
69720 ST BONNET DE MURE - FRANCE  
Tel.: + 33 (0)4.72.48.30.90  
E-mail: flexelec@omerin.com  
www.flexelec.com

### **FLEXELEC Dept**

OMERIN ASIA Pte Ltd  
51 Goldhill Plaza #08-11  
SINGAPORE 308900  
Tel.: + 65.6255.4778  
Fax: + 65.6255.4779  
E-mail: sales@omerin.com.sg

### **FLEXELEC (UK) Ltd**

Unit 11 Kings Park Industrial Estate  
Primrose Hill - KINGS LANGLEY  
Hertfordshire - WD4 8ST - UK  
Tel.: + 44 (0) 1923.274477  
Fax: + 44 (0) 1923.270264  
E-mail: sales@omerin.co.uk

### **FLEXELEC Dept**

OMERIN GmbH  
Buchwiese 16  
D-65510 IDSTEIN - GERMANY  
Tel.: + 49 (0) 6126.94.31-0  
Fax: + 49 (0) 6126.83.99  
E-mail: omeringmbh@omerin.com